

Gaber®

PRICE LIST
2022-23

Gaber®

Acoustic • Outdoor • Office • Hospitality

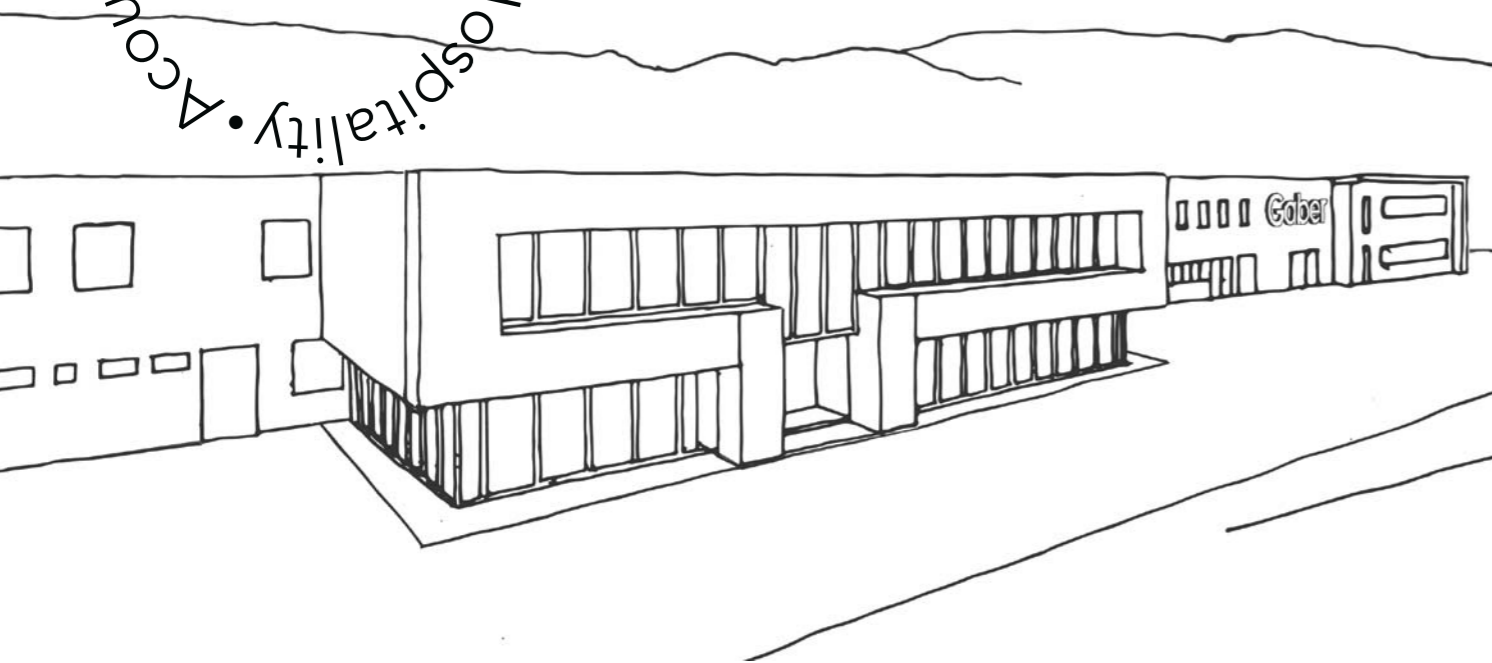

Made in Italy

Contract Furniture

Gaber designs, develops and produces furniture for the contract world, responding to the needs of design, flexibility and quality thanks to the high level of expertise achieved in the molding of plastics and metal processing. Production efficiency, continuous research and great attention to details make it possible to create practical, versatile and long-lasting furnishing solutions.

The total customization at the service of the world of architecture and design make us the ideal partner to style and furnish different environments, all dedicated to hospitality and therefore to the well-being of people sharing moments of work, meeting and relaxation. Projects in which each product has its strong, distinctive features and is part of a furnishing system designed to interpret evolving needs, new times and new meeting places.

Gaber progetta, sviluppa e produce arredi per il mondo contract rispondendo a esigenze di design, flessibilità e qualità grazie all'altissima expertise raggiunta nello stampaggio di materie plastiche e nella lavorazione del metallo. Efficienza produttiva, ricerca continua e grande attenzione ai dettagli permettono di realizzare soluzioni di arredo pratiche, versatili e durature.

La totale customizzazione al servizio del mondo dell'architettura e del design ci rendono il partner ideale per arredare diversi ambienti, tutti orientati all'hospitality e quindi al benessere di persone che condividono momenti di lavoro, di incontro e di relax. Progetti in cui ogni prodotto ha un forte carattere distintivo e si inserisce in un sistema di arredo studiato per interpretare esigenze in divenire, nuovi tempi e nuovi luoghi di incontro.

As pure expression of Made in Italy, Gaber interprets that balance between craftsmanship and industry by creating furnishings able of satisfying the tastes and needs of its international audience, with a high level of customization and a wide range of finishes.

Pura espressione del Made in Italy, Gaber interpreta quell'equilibrio tra artigianato e industria che si realizza in arredi capaci di soddisfare gusti ed esigenze di un pubblico internazionale, con un alto livello di personalizzazione e ampia gamma di finiture.



IN THE NATURAL AND ETHICAL RESPECT

SUSTAINABLE PRODUCTS

Gaber designs, develops and produces furniture for the world of contract, responding to the needs of design, flexibility and quality thanks to the high level of expertise achieved in the molding of plastics and processing metal. Gaber both designs and produces, enabling the realization of innovative products that take into account both human and environmental safety. Since 2000, Gaber has avoided the use of pollutants and has instead encouraged the use of the most valued recycled materials. Gaber carefully launches products complying with the environmental laws in complete respect of the rules, thereby promoting the prevention of environmental pollution.

Safeguarding the environment and a continual search for eco-friendly solutions play an important role within our company where, in recent years, all new launches have been designed and manufactured with respect for our natural environment. This begins with the separate disposal of waste in both offices and on the factory floor: paper, cardboard, plastics, packaging, metal and glass are all separated out and recycled in other internal or external industrial processes, right up to self-sufficient energy production, thanks to the latest generation of photovoltaic (PV) solar panel systems.

PRODOTTI SOSTENIBILI

Gaber progetta, sviluppa e produce arredi per il mondo del contract, rispondendo alle esigenze di design, flessibilità e qualità grazie all'alto livello di competenza raggiunto nello stampaggio delle materie plastiche e nella lavorazione del metallo. Gaber progetta e produce complementi d'arredo di design, permettendo la realizzazione di prodotti innovativi che tengano sempre conto della sicurezza umana e ambientale. Dal 2000 Gaber ha evitato l'uso di sostanze inquinanti, incoraggiando invece, l'uso dei materiali riciclati. Gaber, sempre attenta al lancio sul mercato di prodotti conformi alle più severe leggi di salvaguardia dell'ambiente, promuovendo così la prevenzione dell'inquinamento ambientale.

La salvaguardia dell'ambiente e la continua ricerca di soluzioni eco-compatibili giocano un ruolo importante all'interno dell'azienda dove tutti i nuovi prodotti sono progettati e realizzati nel rispetto dell'ambiente naturale. Iniziando con lo smaltimento separato dei rifiuti negli uffici e nelle aree produttive: carta, cartone, plastica, imballaggi, metallo e vetro sono accuratamente separati e riciclati grazie a processi industriali sia interni che esterni e continua sino alla produzione autonoma di energia grazie ad impianti fotovoltaici di ultima generazione.

MATERIALS / MATERIALI



TECHNOPOLYMER / TECNOPOLIMERO

Gaber production employs exclusively high-tech thermoplastic materials, which are 100% recyclable. Each techno-polymer item is marked with a specific symbol, which shows the kind of polymer for a quick identification and a consequent recycling. Gaber produces plastic injected materials without added chemicals. These materials are purchased within the European Union, so Gaber is exempted from registration with ECHA agency (European Agency for Chemicals Substances), in the complete respect of "Reach Regulation". As far as possible, recycled plastics are sourced as a base raw material, recovered post-consumption.

La produzione Gaber impiega esclusivamente materiali termoplastici altamente innovativi, riciclabili al 100%. Ogni articolo in tecnopolimero è contrassegnato da un simbolo specifico, che identifica il tipo di polimero per una rapida identificazione ed un conseguente corretto riciclaggio. Gaber produce materiali in tecnopolimero iniettato senza aggiunta di sostanze chimiche. Questi materiali sono acquistati all'interno dell'Unione Europea, pertanto Gaber è esente dalla registrazione presso l'agenzia ECHA (Agenzia europea per sostanze chimiche), nel pieno rispetto del "Reach Regulation". Per quanto possibile, i materiali plastici riciclati vengono acquistati come materia prima di base, recuperati da post-consumo.

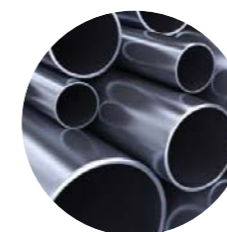

METAL / METALLO

Gaber metal structures, in the full respect of our natural environment, are available with "trivalent" chroming and painted finishes. Prime-quality special epoxy powder coating used on Gaber frames enhance color stability from batch to batch and over time, increasing its corrosion resistance and achieving excellent resistance to atmospheric agents.

Le strutture metalliche Gaber, nel pieno rispetto del nostro ambiente naturale, sono disponibili con cromature "trivalenti" e finiture verniciate. La speciale verniciatura a polvere epossidica di prima qualità utilizzata sui telai Gaber migliora la stabilità del colore da lotto a lotto e nel tempo, aumentandone la resistenza alla corrosione e ottenendo un'ottima resistenza agli agenti atmosferici.



WOOD / LEGNO

Wooden products are manufactured in accordance with the European Regulations in force regarding formaldehyde emissions from wood-based products (E1 according EN717-EN120). Gaber uses wooden raw materials coming from PEFC chain of custody certified materials.

I prodotti in legno sono realizzati in conformità alle Normative Europee vigenti in materia di emissioni di formaldeide da prodotti a base di legno (E1 secondo EN717-EN120). Gaber utilizza materie prime in legno provenienti da materiali certificati catena di custodia PEFC.

PACKAGING / PACKAGING



Corrugated paperboard carton boxes, printed with environmentally friendly inks, are made of at least 80% recycled and recyclable materials, coming from the chain custody FSC Recycled. Packaging is sized in order to optimize storage and transport requirements, both helping the environment and saving on transport costs.

Le scatole di cartone ondulato, stampate con inchiostri ecologici, sono realizzate di almeno l'80% con materiali riciclati e riciclabili provenienti dalla catena di custodia FSC Recycled. Gli imballi sono dimensionati in modo da ottimizzare le esigenze di stoccaggio e trasporto, sia a favore dell'ambiente che di risparmio sui costi di trasporto.



FUNCTION DESIGN AND SUSTAINABILITY / FUNZIONE DESIGN E SOSTENIBILITÀ

Compound Wood by Gaber is an advanced bio-composite where natural wood fibres are incorporated into a polyolefin matrix in order to produce a "Triple-way Ecological" material. This Triple Ecology is achieved by using wood shavings, in their turn completely recyclable, and without the need for any protective polluting treatments.

Compound Wood di Gaber è un Bio-Composito avanzato dove le fibre di legno naturali sono incorporate in una matrice poliolefinica per produrre un materiale "3 volte Ecologico". Ecologico 3 volte perché: utilizza derivati dalla lavorazione del legno, a loro volta completamente riciclabili e non necessita di trattamenti inquinanti protettivi del legno.



Gaber has received several awards for its sustainable Collections, including "Buygreen" award, a testament to Gaber's ongoing commitment to the innovation of its products and materials utilized.

Gaber ha ottenuto diversi riconoscimenti per le sue collezioni sostenibili, tra cui il premio "Buygreen", una testimonianza del continuo impegno di Gaber nell'innovazione dei suoi prodotti e dei materiali utilizzati.



Contract and sustainable furniture





Gaber technopolymer products are made with high quality raw materials: 100% recyclable and eco-friendly.

In the **"ZERO WASTE"** collection, Gaber products are made of completely recycled plastic material: 50% from post-consumer certified plastic waste (PCR) and 50% from industrial plastic waste (PIR).

PCR is an abbreviation for "Post Consumer Recycled" and is the raw material made from waste from the consumer/end user. PIR is an abbreviation for "Post Industrial Recycled" and is the raw material made from waste generated within the industry.

Our know-how, the use of energy generated from renewable sources, combined with the most modern technologies utilized by Gaber for the reduction and recycling of waste, creates long-lasting and functional products, which help to reduce the environmental impact of our work.

However, sustainability does not stop at the sole use of **"ZERO WASTE"** material: this material, in fact, at the end of the product's life cycle, remains totally recyclable and therefore usable to create new products, consequently eliminating material waste. Gaber is therefore at the centre of a circular economic model aimed at increasingly sustainable development, providing services that can improve people's lives and the environment, with a vision of the future aimed at promoting responsible behaviour.

I prodotti Gaber in tecnopolimero sono realizzati con materie prime di alta qualità: riciclabili al 100% ed eco-compatibili.

Nella collezione **"ZERO WASTE"** il prodotto Gaber è realizzato in materiale plastico completamente riciclato: 50% da scarto di materiale plastico certificato post consumo (PCR) e 50% da scarto di materiale plastico industriale (PIR).

PCR è l'abbreviazione di "Post Consumer Recycled" ed è un materiale che deriva da prodotti precedentemente utilizzati dai consumatori. PIR è invece l'abbreviazione di "Post Industrial Recycled" ed è un materiale totalmente riciclato dagli scarti creati dal produttore in fabbrica, recuperato prima di essere utilizzato dal consumatore.

Il nostro know-how, l'utilizzo di energia generata da fonti rinnovabili, unito alle più moderne tecnologie utilizzate da Gaber per la riduzione e il riciclaggio degli scarti, crea prodotti longevi e funzionali, che aiutano a diminuire a priori l'impatto ambientale del nostro lavoro. La sostenibilità non si ferma però al solo utilizzo di materiale **"ZERO WASTE"**: tale materiale, infatti, alla fine del ciclo di vita del prodotto rimane totalmente riciclabile e quindi utilizzabile per creare nuovi prodotti, eliminando di conseguenza gli sprechi di materiale.

Gaber si pone quindi al centro di un modello economico circolare volto ad uno sviluppo sempre più sostenibile, fornendo servizi in grado di migliorare la vita delle persone e dell'ambiente, con una visione del futuro volta a promuovere comportamenti virtuosi.



SAFE PRODUCTS / PRODOTTI SICURI

In all components, parts or materials used by Gaber to make its own products, be they plastic or metal, there are no dangerous substances within the certified limits of the following test methods reports:

In tutti i componenti, parti o materiali utilizzati da Gaber per realizzare i propri prodotti, siano essi plastici o metallici, non sono presenti sostanze pericolose nei limiti certificati dei seguenti metodi e rapporti di prova:

Cadmium/Cadmio UNI EN 13656:2004 + UNI EN 13657:2004 + UNI EN ISO 11885:2009
Lead/Piombo UNI EN 13656:2004 + UNI EN 13657:2004 + UNI EN ISO 11885:2009
Mercury/Mercurio UNI EN 13656:2004 + UNI EN 13657:2004 + UNI EN ISO 11885:2009
Arsenic/Arsenico UNI EN 13656:2004 + UNI EN 13657:2004 + UNI EN ISO 11885:2009
Selenium/Selenio UNI EN 13656:2004 + UNI EN 13657:2004 + UNI EN ISO 11885:2009
Chrome/Cromo VI CEI EN 62321:2009 Annex C
Diisobutil ftalato (DIBP) CPSC-CH-C1001-09.3:2010
Dibutil ftalato (DBP) CPSC-CH-C1001-09.3:2010
Benzilbutil ftalato (BBP) CPSC-CH-C1001-09.3:2010
Di-(2-etilesil) ftalato (DEHP) CPSC-CH-C1001-09.3:2010
Di-n-ottil ftalato (DNOP) CPSC-CH-C1001-09.3:2010
Diisononil ftalato (DINP) CPSC-CH-C1001-09.3:2010
Diisodecil ftalato (DIDP) CPSC-CH-C1001-09.3:2010
Dipentil ftalato (DPP) CPSC-CH-C1001-09.3:2010
Dimetossietil ftalato (DMEP) CPSC-CH-C1001-09.3:2010



Gaber Material "Plastomero/Elastomero" Report n. |Rapporto di prova n. 20205954-002
Gaber Material "Polipropilene" Report n. |Rapporto di prova n. 20205139-002
Gaber Material "Polipropilene R" Report n. |Rapporto di prova n. 20205139-004
Gaber Material "Polipropilene FVR" Report n. |Rapporto di prova n. 20205954-003
Gaber Material "Poliammide" Report n. |Rapporto di prova n. 20205139-003
Gaber Material "PC ABS" Report n. |Rapporto di prova n. 20205139-005
Gaber Material "POM" Report n. |Rapporto di prova n. 20205139-006
Gaber Material "Metal tube | Tubo Metallico" Report n. |Rapporto di prova n. 20205954-001
Gaber Material "Metal Screws-Inserts | Ferramenta Metallica" Report n. |Rapporto di prova n. 20205139-001
Gaber Composite Material "Castors | Ruote" Report n. |Rapporto di prova n. 20205139-007
Gaber Composite Material "Swivel columns | Colonne Girevoli" Report n. |Rapporto di prova n. 20205138-002



RESEARCH AND DEVELOPMENT / RICERCA & SVILUPPO

Gaber, aware of the need to implement courageous initiatives that respond to the ambitious sustainability programme, follows new innovation targets: the new headquarters, with fully centralized integrated automation, allows remote management to minimize any waste of energy and materials.

Particular attention has been paid to bringing back the green that characterizes our landscape: more than 6'000m² have been regenerated, transforming concrete squares and asphalt into parkland, with more than 650 new plants introduced in order to balance production needs with the surrounding environment.



Gaber, consapevole della necessità di implementare iniziative coraggiose che rispondano all'ambizioso programma di sostenibilità, ricorre a nuove dimensioni dell'innovazione: la nuova sede, integralmente controllata da domotica, permette anche la gestione da remoto per minimizzare lo spreco, di energia e di materia.

Particolare attenzione è stata dedicata al riportare il verde che caratterizza il nostro paesaggio: più di 6'000m² sono stati rigenerati, trasformando piazzali in cemento e asfalto in prati, integrando con più di 650 nuove piante l'area, al fine di equilibrare le necessità produttive con l'ambiente circostante.

RECYCLING UNIT

When a production chain works at its best, it also prevents the creation of waste, saves resources and reduces any impact on the environment. To ensure the sustainability of its activities, Gaber invests in latest generation technologies, thanks to which energy consumption is reduced and waste materials reused.

Gaber Recycling Unit is a division of Gaber that allows the recycling of plastic and metal materials from post-industrial consumption, automatically optimizing the separation of different raw materials, which are thus reused in subsequent production runs.

Quando una catena produttiva funziona al meglio, previene anche la creazione di rifiuti, risparmia risorse e riduce l'impatto nei confronti dell'ambiente. Per garantire la sostenibilità delle proprie attività, Gaber investe in tecnologie di ultima generazione, grazie alle quali viene ridotto il consumo di energia e vengono ri-utilizzate le materie di scarto.

Gaber Recycling Unit è una divisione di Gaber che permette il riciclo delle materie plastiche e metalliche da post consumo industriale, differenziando al meglio ed in modo automatico i diversi materiali componenti dei prodotti, che vengono così riutilizzati per una nuova produzione.



SALES CONDITIONS

- All prices are expressed in Euro (VAT excluded)
- All mentioned prices are on EX-works basis.
- Goods travel at customer's own risk.
- Minimum order quantity follows the packaging or multiply, unless otherwise specified. The first box per model must be complete; subsequent incomplete boxes incur a € 6,00 net surcharge.
- Minimum order amount: € 500,00 net. For smaller orders exceptionally accepted , anyway not lower than € 200,00 , upcharge of € 25,00 net.
- Delivery time is approximate , unless differently agreed . Possible delays cannot justify any order cancellation or claim for damages.
- The goods sold through an extended payment are released under the conditions with property reserve until full settlement .
- For any dispute the place of jurisdiction will be the Court of Treviso, Italy.
- Possible complaints must be notified not later than 8 days from receipt of the goods.
- Gaber reserves the right to modify or upgrade the product without prior notice.

GABER® LITERATURE

All Gaber® literature contains technical information and use-suggestions for those who intend to purchase or already have bought items from the Gaber® range. For Customers’ interest, the Company may modify its products without any prior notice. Drawings, quoted materials and catalogue colors and price-lists are shown as a guide onlyand subject to tolerances. Dimensions are provided also in inches (”) has a guide only. The colors displayed in Gaber® literature, related to technopolymer finishing and coverings, fabrics, leather, lacquered or painted materials, wooden items, may change from time to time. Gaber® reserves the right to suspend the production of any of its products without any notice or reason. All rights of reproduction in whole or in part of Gaber® literature, related to text, images or illustration, or transmitted by any means, electronic or mechanical, including photocopying, recording or any information storage without written permission from Gaber®, are reserved worldwide

MATERIALS, USE AND MAINTENANCE

Plastic Materials

The Techno Polymer Compounds Gaber® uses on its products are characterized by high structural resistance, heat and abrasion resistance. Gaber® technopolymers are non-toxic, stain resistant, antistatic and UV-resistant: thanks to all these features these materials have excellent resistance to atmospheric agents. All these materials are recyclable in the full respect of our Natural Environment. Gaber produces plastic injected materials without added chemicals and, as far as possible, recycled technopolymers are sourced as a base raw material, recovered post-consumption.

Guidelines for correct usage: To maintain the Gaber’s techno-polymer products in perfect conditions trough time and guarantee a long lasting quality of the raw materials we hereby recommend very basic care instructions to be followed. Cleaning advices: Techno-polymer surfaces usually needs to be cleaned with a normal cloth and warm water; for the most persistent stains a small amount of liquid soap diluted in water may be used. We recommend to strictly avoid all types of abrasive substances, like for example powdered cleaning products, creams, score pads and rough sponges. Gaber’s techno-polymer products can be sanitized using different substances, for more information check on the web “polypropylene chemicals resistance compatibility”; the use of these substances also depends on the temperature, pressure and concentration. It is always a good practice, after sanitizing the techno-polymer products with these substances, rinse immediately the products with water. Any liquid spilt on the product must be wiped up immediately. Even products made especially for outdoor purposes could be affected by atmospheric agents. Products may undergo exterior changes due to particular exposure to heat, humidity and salinity. Products may change color and shade if exposed to direct sunlight. An appropriate and frequent maintenance and cleaning of the products enhances its durability. Maintenance has to be carried out by experienced staff.

Gaber® glides and floorpads are made of blended rubber for heavy-duty use and are designed to minimise noise. Certain Gaber® items come ready-fitted with felt floorpads, specifically for hard or especially delicate floors.

Gaber® manufactures some bespoke products of its collection with fire retardant techno polymer: the additives that make the fireproof plastic can substantially change the aesthetics and durability of the product.

Steel

High-resistance steel is used to produce frames for chairs, stools and tables by using square or round tubes as well as solid rod. Products are available in chrome or painted finishes. Special epoxy powder coating used on many Gaber® structures achieves excellent resistance to atmospheric agents.

Aluminum

Gaber® use aluminum to produce frames for chairs, stools and tables. Aluminum surfaces can be anodized, and Gaber® use this special treatment in order to increase resistance to corrosion.

Guidelines for correct usage: both steel and aluminum surfaces usually need to be cleaned with a normal cloth and warm water. For the most persistent stains, a small amount of mild liquid soap diluted in water may be used. Any liquid spilt on the product must be wiped up immediately. We recommend avoiding all types of abrasive creams or pastes, abrasive sponges, chlorine, bleach or strong detergents.

Wood

Our wooden products are produced in accordance with the European Regulations in force regarding formaldehyde emissions from wood-based products.

Guidelines for correct usage: Wooden products, being natural materials, can be damaged easily. Small impurities or imperfections are within quality standard range. Plywood surfaces need to be cleaned with a cloth and water. We recommend drying immediately after the cleaning process.

Flexible polyurethane padding

The flexible polyurethane cold-pressed paddings Gaber® uses on some of its upholstered products do not contain CFC/HCFC (ODP=0: do not contribute the reduction of the atmospheric ozone layer), they are fire-retardant class 1-IM UNI 9175 / CMHR following European Standards.

Coverings: Fabrics and Leathers

Gaber® uses fabrics and leathers that belong to a wide range of colors and patterns, which are all tested in order to achieve the best performance, among which resistance to abrasion and artificial light. Fire-retardant fabrics and eco-leather upholstery are also available.

Guidelines for correct usage: Clean leathers with a soft cloth with water. Refer to technical specifications for fabric cleaning.

PACKAGING AND RECYCLING

Our packages are designed to optimize storage and transport requirements, they are made of 90% recycled raw material and are completely recyclable in themselves. The optimization of packaging in terms of volume and weight delivers a lower consumption of energy in many forms, helping the environment and a consequent saving on transport costs. In order to avoid the loss of components, packaging must be disposed only after completing the assembly of the products. Once the product has been dismantled, the product itself or its components must be given to public garbage system, according to local rules.

INNAPROPRIATE USES OF THE PRODUCT

Avoid any improper use of the product; do not step on the product, do not stand on footrest or on armrests, do not seat on the back or on armrest, do not use the chair as a ladder. The product should not be subjected to swinging back and forwards that may damage the furniture or result in injury to the user. When lifting or moving the product, hold it by the main structure and not just under the seat. Gaber® will accept no liability for any damages caused to property or persons subsequent to incorrect or improper handling of the product. Gaber® also declines any responsibility in cases of damage caused to fragile floors.



CONDIZIONI GENERALI DI VENDITA

- I prezzi sono espressi in Euro (IVA esclusa)
- Resa della merce: franco fabbrica.
- La merce viaggia a rischio e pericolo del committente
- Ordine Minimo: pari all’imballo o multipli dello stesso, salvo diversamente specificato. Il primo imballo per ogni modello deve essere completo, ulteriori imballi incompleti subiranno un sovrapprezzo di € 6,00 netti.
- Importo minimo ordine: € 500,00 netti netti. Per ordini inferiori accettati eccezionalmente , comunque non inferiori a € 200,00 , addebito di spese fisse per € 25,00 netti.
- I tempi di consegna sono indicativi salvo nostra conferma esplicita. Eventuali ritardi non possono dar luogo a pretese di danni o annullamenti dell’ordine.
- La merce venduta con pagamento dilazionato è rilasciata con condizioni di riserva di proprietà fino a completo pagamento .
- Per ogni controversia è competente il foro di Treviso , Italia.
- Eventuali reclami devono essere comunicati entro 8 giorni dal ricevimento della merce.
- Gaber si riserva la facoltà di apportare modifiche o migliorie senza alcun preavviso.

DOCUMENTAZIONE GABER®

La documentazione Gaber® contiene informazioni tecniche e consigli d’uso per chi vuole acquistare o possiede articoli facenti parte della gamma prodotti Gaber®. Nell’interesse della clientela, Gaber® si riserva il diritto di modificare i propri modelli in ogni momento, senza obbligo di preavviso. I disegni, le quote, i materiali ed i colori dei cataloghi e del listino Gaber® si intendono a titolo puramente indicativo, e soggetti a tolleranze. Le dimensioni in pollici (”) sono da considerarsi indicative. I toni di colore rappresentati o presenti nelle palette colori e rivestimenti, relativi ai tessuti, alla pelle, alle laccature, ai vetri, e alle essenze legno, sono indicativi, in quanto passibili di variazioni da partita a partita. Gaber® declina ogni responsabilità in relazione a leggere differenze di tonalità. Gaber® si riserva inoltre il diritto di ritirare, sospendere o cessare la produzione di ogni singolo suo prodotto in qualsiasi momento e a sua discrezione senza darne preventivo avviso. Tutti i diritti di riproduzione, anche parziale, di cataloghi e listini Gaber® relativi a testi, immagini, illustrazioni, disegni, sia con mezzi meccanici che elettronici, incluso fotocopia o la formazione di sorgenti di informazione, senza il preventivo permesso scritto di Gaber®, sono globalmente riservati.

MATERIALI UTILIZZATI E MANUTENZIONE

Le Materie Plastiche

I compound di tecnopolimeri utilizzati da Gaber® nella realizzazione dei propri prodotti sono caratterizzati da un’elevata resistenza strutturale, termica e all’abrasione. Il tecnopolimero componente dei prodotti Gaber® è atossico, antimacchia, antistatico e anti-uv: qualità che lo rendono ottimamente resistente agli agenti atmosferici. I tecnopolimeri utilizzati da Gaber® sono integralmente riciclabili, nel pieno rispetto del nostro Ambiente Naturale. Gaber produce articoli termoplastici senza additivi chimici e, ove possibile, vengono utilizzati tecnopolimeri riciclati derivanti da post-consumo.

Piccole Accortezze: Per mantenere i prodotti Gaber in tecnopolimero in perfette condizioni nel tempo e garantire una qualità duratura delle materie prime, raccomandiamo di seguire le seguenti semplici istruzioni di utilizzo e manutenzione. Consigli per la pulizia: normalmente le superfici in tecnopolimero devono essere pulite con un normale panno e acqua calda; per le macchie più persistenti si può utilizzare una piccola quantità di sapone liquido diluito in acqua. Si consiglia di evitare rigorosamente tutti i tipi di sostanze abrasive, come ad esempio prodotti per la pulizia in polvere, creme, tamponi e spugne ruvide. I prodotti in tecnopolimero Gaber possono essere sanificati utilizzando diverse sostanze, per maggiori informazioni verificare sul web “compatibilità resistenza chimica polipropilene” ; l’uso di queste sostanze dipende anche dalla temperatura, pressione e concentrazione. È sempre buona norma, dopo aver igienizzato i prodotti in tecnopolimero con queste sostanze, sciacquare immediatamente i prodotti con acqua. I liquidi versati sul prodotto devono essere asciugati subito. I prodotti destinati all’uso esterno subiscono comunque nel tempo l’azione degli agenti atmosferici. Eventuali alterazioni superficiali possono verificarsi a specifiche condizioni di temperatura, umidità e salinità. Il prodotto se esposto alla luce diretta del sole può essere soggetto a variazioni di colore. Una corretta e frequente manutenzione e pulizia aumentano la durabilità del prodotto. Interventi di manutenzione devono essere eseguiti da personale esperto.

I tappi e le protezioni dei prodotti Gaber® sono realizzati in una miscola di gomma ad alta resistenza all’ usura, atta a diminuire il rumore da trascinamento. Alcuni prodotti Gaber® sono dotati di tappi con feltri, adatti a pavimenti rigidi e più delicati.

Gaber® realizza su commessa alcuni prodotti della propria collezione con tecnopolimeri ignifughi: gli additivi che rendono il manufatto plastico ignifugo possono variare sostanzialmente l’estetica e la resistenza del prodotto.

L’ Acciaio

L’acciaio ad alta resistenza è utilizzato nelle strutture di tavoli, sedie e sgabelli, realizzati da Gaber® per mezzo di tubolari a sezione quadrata e rotonda, o con tondino. I prodotti sono disponibili con finitura cromata o verniciata. La speciale verniciatura a polveri epossidiche utilizzata da Gaber® per alcune strutture dei propri prodotti raggiunge una resistenza ottimale agli agenti atmosferici.

L’ Alluminio

Gaber® utilizza l’alluminio per realizzare le strutture di tavoli, sedie e sgabelli. La finitura per mezzo del trattamento superficiale di anodizzazione, utilizzata in alcuni prodotti, ha lo scopo di aumentarne la resistenza alla corrosione.

Piccole Accortezze: sia le superfici metalliche in acciaio che in alluminio devono essere pulite con un panno umido e soffice imbevuto in acqua calda. Per le macchie più ostinate è possibile diluire in acqua del sapone neutro liquido con moderazione. Asciugare sempre dopo la pulizia con un panno morbido. Non usare creme o paste per pulire i metalli, non usare cloro, candeggina o detergenti aggressivi. Non usare paste o spugne abrasive che possano graffiare le superfici metalliche.

Il legno

I prodotti Gaber® con elementi in legno sono prodotti di accordo con le vigenti normative Europee rispetto alle emissioni di formaldeide.

“Compound-wood” è il particolare materiale utilizzato da Gaber® per la realizzazione dei prodotti Alhambra-Eco ed Epica-Eco. Questo materiale utilizza fibre di legno derivanti dagli stessi processi di produzione con cui Gaber realizza elementi in materiale legnoso. Niente viene sprecato.

Piccole Accortezze: Le superfici in legno, essendo un materiale naturale, potrebbero, nel tempo, subire alterazioni di colore con l’utilizzo e con l’esposizione alla luce. Inoltre, per loro natura, tali superfici sono facilmente danneggiabili, alcune piccole impurità e imperfezioni rientrano negli standard di qualità accettati. Le superfici in legno non possono sopportare fonti di calore dirette.

Pulire le superfici in legno con un panno umido e soffice, imbevuto in acqua tiepida. Asciugare immediatamente dopo la pulizia.

Le imbottiture in poliuretano flessibile

Le imbottiture di alcuni prodotti Gaber® sono realizzate in poliuretano flessibile, stampato a freddo, privo di CFC/HCFC (ODP=0 : non contribuisce alla riduzione dello strato di ozono atmosferico), autoestinguente classe 1-IM Uni 9175 / CMHR, seguendo le normative Europee in materia.

I rivestimenti: tessuti e pelli

Tessuti e Pelli utilizzati da Gaber® appartengono ad un’ampia gamma di colori e trame, tutti scelti tra un range di prodotti testati con l’obiettivo di ottenere le migliori caratteristiche prestazionali, quali la resistenza all’abrasione, allo sfregamento e alla resistenza alla luce artificiale. Sono disponibili categorie di tessuti ignifughi e rivestimenti in finte pelli.

Piccole Accortezze: pulire le Pelli con un panno bianco umido di sola acqua. Per la pulizia dei tessuti consultare la scheda tecnica specifica.

IMBALLI E RICICLO

I nostri imballi sono realizzati con l’obbiettivo di ottimizzare trasporti e stoccaggio; sono realizzati per il 90% di materiali riciclati e totalmente riciclabili. L’ottimizzazione dell’imballo in termini di volume e peso comporta un minore dispendio di energia, con un conseguente risparmio nei costi di trasporto e un importante aiuto alla salvaguardia del nostro Ambiente Naturale. E’ consigliabile lo smaltimento degli imballi solo a completamento dell’assemblaggio, onde evitare lo smarrimento di eventuale ferramenta e componenti. Una volta dismesso, il prodotto o i suoi componenti vanno conferiti ai sistemi pubblici di smaltimento secondo quanto previsto dalla legislazione locale in vigore.

USO IMPROPRIO DEI PRODOTTI

Sono da considerarsi usi impropri e/o scorretti del prodotto il salire in piedi su tavoli, sedie, sgabelli, poggiapiedi, sedersi su schienali, braccioli, utilizzare i prodotti come scaletta. Evitare oscillazioni che potrebbero pregiudicare il funzionamento e la sicurezza dell’utente. Per sollevare o spostare un prodotto non afferrare sotto il sedile, bensì afferrare saldamente la struttura portante. Il prodotto non deve essere sottoposto a carichi decentrati, è stato progettato per essere utilizzato in condizioni normali di appoggio (su quattro gambe o sulla base). Gaber® declina ogni responsabilità per danni causati a cose o a persone derivanti da uso non corretto del prodotto; l’azienda inoltre si solleva da ogni responsabilità per danni provocati su pavimenti e superfici delicate o tenere.



CONDICIONES GENERALES DE VENTA

- Todos los precios son en Euro (IVA no incluido)
- Portes: debidos (ex-works)
- Toda la mercancía viaja por cuenta y riesgo del comprador.
- Cantidad mínima por cada pedido: igual al embalaje o múltiplo de lo mismo, a menos que se especifique lo contrario. El primer empaque para cada modelo debe estar completo, los paquetes incompletos tendrán un coste adicional de € 6,00 netos.
- Valor mínimo de pedido: € 500,00 netos. Para pedidos inferiores, excepcionalmentes aceptados, y del valor mínimo de € 200,00 netos hay un coste fijo extra de € 25,00 netos.
- Los plazos de entrega son indicativos, exepto si lo mismos han sido establecidos por parte de nuestra empresa. En caso de retraso en la entrega no se aceptan cancelaciones de pedidos o peticiones de reembolso.
- La mercancía vendida con pago diferido, se entrega con derecho de reserva de propiedad hasta el pago total de la misma.
- Para cualquier queja, el foro de competencia es el de Treviso, Italia.
- No se admiten reclamaciones efectuadas con posterioridad a los 8 días de la entrega de la mercancía.
- Gaber se reserva el derecho de poder modificar o mejorar sus productos sin previo aviso.

DOCUMENTACION GABER®

Toda la documentación Gaber® contiene una serie de informaciones técnicas y consejos para el utilize para quién quiera comprar o para quién posea productos pertenienices a la gama Gaber®. En el interés de los clientes, Gaber® se reserva el derecho de poder modificar o mejorar sus productos sin avisar antes.

Los dibujos, las medidas, los materiales y los colores se ilustran exclusivamente a modo de ejemplo y son indicativas, sujetos a tolerancias. Las tonalidad de los colores del muestrario relativas a las telas, pieles, pintura, esencias de las maderas, pueden variar según partida.

Gaber® declina todo tipo de responsabilidades con relación a pequeñas diferencias de color. Gaber® se reserva además el derecho de ritirar, suspender o cesar la producción de cualquier producto en cualquier momento y a propia discreción sin dar previo aviso.

Todos los derechos de reproducción, incluso parcial, de los catálogos y listas de precios Gaber® relativos a los textos, imagines, ilustraciones, diseños ya sea por medios mecánicos o electrónicos, incluyendo el fotocopiado o la formación de fuentes de información, sin el permiso previo por escrito de Gaber®, son reservados a nivel mundial.

MATERIALES, USO Y MANTENIMIENTO

Material Plástico

Tecno Polímeros compuestos que Gaber® utiliza en sus productos se caracterizan por una alta resistencia estructural, al calor y una alta resistencia a la abrasión. Los Tecno Polímero de Gaber® no son tóxicos, son resistentes a manchas, antiestáticos y UV-resistente: gracias a esto los materiales tienen una excelente resistencia a los agentes atmosféricos. Todos estos materiales son reciclables en el pleno respeto de nuestro medio ambiente. Gaber® produce plástico inyectado sin productos químicos y materiales añadidos y, cuando sea posible, tecnopolímero reciclados se obtienen como materia prima básica, recuperado de post-consumo.

Pequeñas atenciones a: Para mantener los productos de tecnopolímero de Gaber en perfectas condiciones y garantizar una calidad duradera de las materias primas, recomendamos seguir unas instrucciones de cuidado muy básicas. Consejos de limpieza: Las superficies de tecnopolímero generalmente deben limpiarse con un paño normal y agua tibia; para las manchas más persistentes se puede utilizar una pequeña cantidad de jabón líquido diluido en agua. Recomendamos evitar estrictamente todo tipo de sustancias abrasivas, como, por ejemplo, productos de limpieza en polvo, cremas, estropajos y esponjas rugosas. Los productos de tecnopolímero de Gaber se pueden desinfectar con diferentes sustancias. Para obtener más información, consulte en la web “compatibilidad de resistencia a productos químicos de polipropileno”; el uso de estas sustancias también depende de la temperatura, presión y concentración. Siempre es una buena práctica, después de desinfectar los productos de tecnopolímeros con estas sustancias, enjuagar inmediatamente los productos con agua. Cualquier fracción de líquido sobre el producto debe ser borrado de inmediato. Incluso los productos hechos especialmente para el exterior podrían ser afectados por los agentes atmosféricos. Productos podrían someterse a posibles cambios en la exposición especial al calor, la humedad y la salinidad. En casos excepcionales y para una vida larga, los productos podrían cambiar de tonalidad y sombra, si se expone a fuerte luz solar directa. Un mantenimiento y limpieza adecuada y frecuente de los productos aumenta su durabilidad. Mantenimiento tiene que llevarse a cabo por personal de experiencia.

Los tapones de los productos Gaber® están hechos de un compuesto de goma de alta resistencia al desgaste, que reduce el ruido de arrastre. Algunos productos Gaber® están equipados con tapones con fieltro, adecuados para suelos duros y más delicados.

Gaber® fabrica sobre pedido algunos productos de su colección con tecno polimero retardante de fuego: los aditivos que hacen que el producto de plástico sean a prueba de fuego pueden variar sustancialmente la estética y la durabilidad del producto.

Acero

Acero de alta resistencia se utiliza para producir las estructuras de las sillas y de las mesas, utilizando tubos cuadrados o redondos, así como barilla sólida. Los productos están disponibles en cromo o acabados pintados. La pintura en polvo epoxi especial, utilizada en muchas estructuras Gaber®, logra una excelente resistencia a los agentes atmosféricos.

Aluminio

Gaber® utiliza aluminio, ligero y resistente, para producir estructuras para las sillas y las mesas. Superficies de aluminio pueden ser anodizado, y Gaber® utilizan este tratamiento especial con el fin de aumentar la resistencia a la corrosión.

Pequeñas atenciones a: tanto las superficies de aluminio que acero se deben limpiar con un paño normal y agua tibia. Para las manchas más persistentes se puede usar una pequeña cantidad de jabón líquido suave diluido en agua. Cualquier fracción de líquido sobre el producto debe ser borrado de inmediato. Se recomienda evitar todo tipo de cremas abrasivas o pastas, esponjas abrasivas, cloro, lejía o detergentes fuertes.

Las Maderas

Nuestros artículos de madera se producen de acuerdo con la normativa europea vigente en materia de emisiones de formaldehido de los productos a base de madera. Gaber utiliza materias primas de madera que vienen exclusivamente de la cadena de custodia PEFC de materiales certificados.

Pequeñas atenciones a: artículos de madera, siendo materiales naturales, podrían dañarse fácilmente. Las pequeñas impurezas o imperfecciones están dentro del rango estándar de calidad. Superficies de madera moldeada deben ser limpiadas con un paño y agua. Se recomienda secar inmediatamente después del proceso de limpieza.

Espumas

Gaber® utiliza en algunos de sus artículos tapizados una espuma de poliuretano inyectada dentro de un molde, toda las espumas no contienen CFC / HCFC (ODP = 0: no contribuyen a la reducción de la capa de ozono de la atmósfera), y son de clase ignifugo 1-IM Uni 9175 siguiendoos Normas europeas.

Revestimientos: Telas y Piel

Gaber® utiliza tela y piel que pertenecen a una amplia gama de colores y diseños, que son todos probados a fin de lograr las mejores prestaciones, entre las que la resistencia a la abrasión y la luz artificial. Telas ignifugas y para exterior, tapicería en eco-piel, también están disponibles.

Pequeñas atenciones a: limpieas pieles con un paño suave con agua. Consulte las especificaciones técnicas de limpieza para las telas.

EMPAQUE Y RECICLABILIDAD

La gama de productos Gaber® está constituida por la mayor parte de elementos completamente reciclables. Nuestros embalajes se escalan con el fin de optimizar los requisitos de almacenamiento y de transporte, que están hechos de 90% materia prima reciclada y son totalmente reciclables. La optimización de los embalajes en términos de volumen y peso ofrece un menor consumo de energía en muchas formas, ayudando al medio ambiente y el consiguiente ahorro en los costes de transporte. A fin de evitar la pérdida de componentes, el embalaje debe eliminarse sólo después de completar el montaje de los productos. Una vez que el producto ha sido desmantelado, el propio producto o sus componentes se debe dar a sistema público de reciclaje, de acuerdo con las normas locales.

USOS INADECUADO DEL PRODUCTO

Evite cualquier uso inadecuado del producto; no subir/caminar sobre el producto, no se pare en el reposapiés o en los brazos, no sentarse en el espaldar o en el reposabrazos, no utilice la silla como una escalera. El producto no debe ser sometido a pesos desequilibrados, ya que está diseñado para un descanso adecuado en el punto de apoyo (en cuatro patas o en la base). Cuando levante o mueva el producto, manténgalo en la estructura principal y no sólo bajo el asiento. Gaber® aceptará ninguna responsabilidad por los daños y perjuicios causados a bienes o personas posteriores a un manejo incorrecto o inadecuado del producto. Gaber® se libera de cualquier responsabilidad en caso de daños causados a los suelos frágiles.



CONDITIONS GENERALES DE VENTE

- Les prix sont en Euro (H.T.).
- Marchandise vendue depart usine.
- La marchandise voyage sous la responsabilité du client.
- Commande minimum: nous demandons de respecter le colisage indiqué et ses multiples, sauf en cas de confirmation explicite de notre part. Le premiere colisage pour chaque modèle doit être complet, tout décolisage exceptionnel sera suivi d’un surcout de € 6,00 net.
- Minimum de commande € 500,00 net achat H.T. Pour toute commande acceptée exceptionnellement inférieure à ce montant et de tout façon non inférieure à € 200,00, nous ajouterons € 25,00 de frais fixe.
- Les délais de livraison sont indicatifs, sauf en cas de confirmation explicite de notre part. Tout retard n'est pas imputable et ne pourra pas donner lieu à une demande de dédomagement ou à l'annulation de la commande en cours.
- Gaber se réserve le droit de propriété sur la marchandise en cas de paiement échelonné, tant que la dernière échéance n'a pas été honorée.
- Pour toute contestation, le tribunal de compétence sera Treviso, Italia.
- Tous dommanges ou manquants doivent être signalés par mail ou fax dans les 8 jours qui suivent la livraison.
- Gaber se réserve le droit de modifier ses modèles, à n'importe quel moment, sans aucun préavis.

DOCUMENTATION GABER®

Notre documentation contient des informations techniques et des conseils pour l'utilisation des produits, pour les futurs clients Gaber® ou pour qui est déjà en possession d'un produit Gaber®. Dans l'intérêt de la clientèle, Gaber® se réserve le droit de modifier ses modèles, à n'importe quel moment, sans aucun préavis.

Les dessins, les descriptions, les cotes, les matériaux et les couleurs du catalogue et du tarif sont purement indicatifset sous réserve des tolérances. Les dimensions en pouce sont indicatives. Les tonalités des couleurs qui sont représentées sur la carte couleur, relatives aux tissus, au cuir, aux polipro, aux essences de bois sont purement indicatives car elles peuvent varier d'un lot à un autre. Gaber® décline toute responsabilité en ce qui concerne toute différence de tonalité.

Gaber® se réserve le droit de retirer, de suspendre ou de cesser la production de tout article, sans aucun préavis. Tout droit de reproduction, même partielle, des catalogue, relatif aux textes, images, illustrations, dessins, par des moyens mécaniques, électroniques, par photocopie, ou autre source d'information, sans le consentement préalable de Gaber®, est réservé.

MATERIAUX UTILISES ET LEUR ENTRETIEN

Matière plastique

Les billes de technopolymer utilisées par Gaber® pour fabriquer ses produits ont les caractéristiques suivantes : résistance structural thermique et à l'abrasion. Le technopolymer est non toxique, il est anti statique et anti UV ; ces qualités le rendent très résistant aux agents atmosphériques. Le technopolymer est entièrement recyclable, dans le respect de la charte écologique.

Quelques informations pour l'entretien : pour maintenir les produits techno-polymères Gaber dans des conditions parfaites et garantir une qualité durable des matières premières, nous recommandons par la présente des instructions d'entretien très basiques à suivre. Conseils de nettoyage: Les surfaces en technopolymère doivent généralement être nettoyées avec un chiffon normal et de l'eau tiède; pour les taches les plus tenaces, une petite quantité de savon liquide dilué dans l'eau peut être utilisée. Nous vous recommandons d'éviter strictement tous les types de substances abrasives, comme par exemple les produits de nettoyage en poudre, les crèmes, les tampons de score et les éponges rugueuses. Les produits technopolymères de Gaber peuvent être désinfectés à l'aide de différentes substances, pour plus d'informations, consultez le site Web «Compatibilité de résistance aux produits chimiques du polypropylène»; l'utilisation de ces substances dépend également de la température, de la pression et de la concentration. C'est toujours une bonne pratique, après avoir désinfecté les produits technopolymères avec ces substances, rincer immédiatement les produits à l'eau. Le liquide versé sur un plateau doit être immédiatement essuyé, les articles réservés à un usage externe peuvent subir à la longue l'action d'agents atmosphériques, tels que la salinité,l'humidité, les rayons de soleil, qui peuvent en altérer la superficie et la couleur. Nous recommandons un entretien régulier ainsi qu'un nettoyage correcte et fréquent, ce qui augmentera la durée de vie du produit. L'entretien doit être effectué par des personnes expertes.

Les bouchons des produits Gaber® sont faits d'un composé en caoutchouc à haute résistance d'usure, qui réduit aussi le bruit de traînée. Certains produits Gaber® sont équipés de bouchons avec feutre, adaptés aux sols durs et plus délicats.

Gaber® réalise sur demande, certains articles de sa collection, en polymer “ignifugé” ; cependant les additifs qui rendent le produit plastique “ignifugé” peuvent en varier l'esthétique et la résistance.

Acier

L'acier utilisé pour la fabrication des structures de tables, chaises, et tabourets Gaber® est très résistant. Il est travaillé sous forme de tube à section carrée ou ronde. La finition peut être chromée ou vernis. Le vernissage spécial à époxy, utilisé par Gaber®, a une résistance optimale aux agents atmosphériques.

Aluminium

L'aluminium anodisé utilisé pour la réalisation de structures de tables, chaises et tabourets augmente la résistance à la corrosion. Conseil d'entretien pour les surfaces en acier et/ou en aluminium: nettoyer avec un chiffon doux, humide, imprégné d'eau chaude. Pour les taches éventuelles, on peut ajouter un peu de détergent à usage domestique. Il est recommandé de bien sécher la surface ensuite. Il ne faut pas utiliser de pate et/ou crème pour métal, il ne faut pas utiliser de chlore, de javel ou autre détergents agressifs. Il ne faut pas utiliser de pate ou d'éponges abrasives, qui pourraient endommager en les rayant, les superficies.

Bois

Les articles Gaber® avec bois, sont fabriqués selon les norms européennes en vigueur, sans formaldehyde. (par rapport à l'émission de formaldehyde). Le matériel utilisé pour la fabrication des articles ALHAMBRA ECO et EPICA ECO est un mélange de sciure de bois rendu compact et dérivant de matériel recyclé. Il n'y a ainsi aucun gaspillage. Le bois étant une matière naturelle, peut, avec le temps et suivant l'expositionà la lumière, subir de légères modifications au niveau de la couleur. Ces produits, de par leur nature, peuvent s'abimer facilement ; nous tenons aussi à préciser que certaines imperfections correspondent à un standard normal de qualité. Il est recommandé enfin, de ne pas approcher la superficie à une source de chaleur directe. Les superficies se nettoient à l'aide d'un chiffon doux, légèrement humide. Sécher toujours ensuite.

Rembourrage en polyuréthane « flexible »

Le rembourrage de certains articles Gaber® est réalisé en polyurethane « flexible », injecté à froid, sans particules de CFC/HCFC (ODP=0 , ne réduit pas la couche d'ozone), ignifugé en classe 1-IM UNI 9175 / CMHR, selon les normes européennes en vigueur.

Revêtement : tissus et cuir

Gaber® a au choix une large gamme de couleurs et de trames, choisis parmi des tissus, des cuirs, des ecopelle testés et garantissant une bonne résistance aux frottements, aux abrasions, à la lumière artificielle. Nous avons aussi une gamme de revêtements non feu. Informations et entretien : nettoyer les peaux avec un chiffon blanc, légèrement humide. Pour l'entretien des tissus, consulter la fiche technique, spécifique.

EMBALLAGE ET RECYCLAGE

Nos emballages sont conçus de façon à optimiser le transport et le stockage ; ils sont réalisés à 90% avec du matériel recycle et sont complètement recyclables. L'emballage, optimisé au maximum en ce qui concerne son volume et son poids, permet une économie d'énergie, de main d'oeuvre et de cout de port, sans oublier la sauve garde de notre environnement. Il est vivement conseillé de monter complètement l'article Gaber® avant de procéder à l'élimination du carton, ceci, afin d'éviter de perdre la visserie et / ou les divers composants de l'article en question.

Lorsqu'un produit Gaber® arrive en fin de vie, il est recommandé de porter les diverses parties qui le compose à la déchèterie, selon la loi du pays en vigueur

USAGE INCORRECT DES PRODUITS

Les tables, chaises, tabourets ou repose pieds ne sont pas fait pour monter dessus, il ne faut pas s'asseoir sur les dossiers ou les accoudoirs ou se servir de ces articles comme d'un escabeau. Il faut éviter de se balancer d'avant en arrière sur les assises, de façon à éviter les accidents. Pour soulever ou déplacer une chaise ou tabouret, il est recommandé de le prendre par le châssis et non par l'assise. Le produit ne doit pas être soumis à des charges excessives ou décentrées, il a été conçu pour un usage normal de simple appui (sur 4 pieds ou sur pied central).

Gaber® décline toute responsabilité pour les dommages causes à personne ou choses, qui pourraient dériver d'un usage incorrect du produit. L'usine décline aussi toute responsabilité pour les dommages sur parquets ou sol délicats.



ALLGEMEINE VERKAUFSBEDINGUNGEN

- Die Preise werden in Euro ausgedrückt (MwSt. ausgeschlossen)
- Die Rückgabe der Ware erfolgt ab Werk
- Die Ware reist auf Gefahr des Auftraggebers

• Sofern nicht anders angegeben, entspricht die Mindestbestellmenge der Verpackung bzw. mehrfachen dergleichen. Die erste Verpackung muss vollständig sein.

Für andere unvollständige Verpackungen wird ein Aufpreis von € 6,00 angerechnet.

- Der Mindestnettoertrag der Bestellung beträgt € 500,00. Bestellungen mit niedrigeren Beträgen werden ausnahmsweise angenommen. Jedenfalls dürfen diese den Nettobetrag von € 200,00 nicht unterschreiten und es werden zusätzlich Fixkosten in Höhe von € 25,00 angerechnet.

• Die Lieferzeiten gelten als reine Orientierung. Bei Verspätungen können keine Schadensersatzansprüche geltend gemacht oder die Bestellung storniert werden.

• Ein Zahlungsaufschub wird unter Eigentumsvorbehalt der Ware bis zur vollständigen Bezahlung gewährt.

• Für eventuelle Streitigkeiten oder Auseinandersetzungen ist das Forum von Treviso (Italien) zuständig.

• Eventuelle Beschwerden müssen innerhalb von 8 Tagen ab Erhalt der Ware mitgeteilt werden.

• Gaber behält sich das Recht Änderungen und Verbesserungen an der Ware, auch ohne Vorankündigung, vorzunehmen.

GABER® DOKUMENTATION

Die Dokumentation von Gaber® beinhaltet technische Informationen und Ratschläge zur Nutzung von Gaber® Produkte für Kaufinteressenten bzw. für Besitzer von Artikeln, die zur Produktpalette der Gaber® angehören. Im Interesse der Kunden behält sich Gaber® das Recht vor die eigenen Modelle jederzeit abzuändern, ohne Pflicht zur Vorankündigung. Die Zeichnungen, die Quoten, die Materialien und die Farben der Kataloge und der Preislisten der Gaber® dienen lediglich als Information und unterliegen Toleranzen. Die Maßen, die in Zoll angegeben sind, sind als Richtwerte zu betrachten. Die dargestellten Farbtöne, auch die in den Farbpaletten, sowie die Stoff-, Leder-, Lack-, Glas- und Holzverkleidungen sind Indikativ, da von Fall zu Fall Änderungen möglich sind. Gaber® lehnt jegliche Verantwortung in Verbindung mit Farbtonabweichungen ab. Gaber® behält sich zudem das Recht vor die Produktion jedes einzelnen Produkts zurückzuziehen, einzustellen bzw. abzutreten. Die Rechte an der Reproduktion von Kataloge und Preislisten der Gaber® in Bezug auf Texte, Bilder, Illustrationen, Zeichnungen, die sowohl mit mechanischen als auch mit elektronischen Mitteln, Kopien inbegriffen, erfolgen sind weltweit der Gaber® vorbehalten und benötigen eine schriftliche Genehmigung der Gaber®.

VERWENDETE MATERIALIEN UND WARTUNG

Kunststoffmaterialien

Die von Gaber® benutzte „Tecnopolymer-Verbindung“ für die Realisierung der eigenen Produkte sind durch hohe strukturelle, thermische und abriebfeste Resistenz gekennzeichnet. Das „Tecnopolymer“, welcher Bestandteil der Produkte Gaber® ist, ist ungiftig, schmutzabweisend, antistatisch und anti-UV. Eigenschaften, die der Produkte Gaber® eine optimale Resistenz gegen die atmosphärischen Einflüsse verleiht. Die verwendeten „Tecnopolymer“ sind, in Beachtung der Umwelt, vollständig recycelbar. Gaber® produziert thermoplastische Artikel ohne chemische Zusätze und, wo möglich, wird recyceltes „Tecnopolymer“ aus wiederverwendeten Altstoffen benutzt.

Richtlinien für die korrekte Verwendung: Richtlinien für die korrekte Verwendung: Um die Technopolymerprodukte von Gaber während der gesamten Zeit in einwandfreiem Zustand zu halten und eine lang anhaltende Qualität der Rohstoffe zu gewährleisten, empfehlen wir hiermit grundlegende Anweisungen zur Pflege. Reinigungshinweise: Technopolymeroberflächen müssen normalerweise mit einem normalen Tuch und warmem Wasser gereinigt werden. Für die hartnäckigsten Flecken kann eine kleine Menge in Wasser verdünnter Flüssigseife verwendet werden. Wir empfehlen, alle Arten von Schleifmitteln, wie z. B. pulverförmige Reinigungsprodukte, Cremes, Scorepads und grobe Schwämme, strikt zu vermeiden. Gabers Technopolymerprodukte können mit verschiedenen Substanzen desinfiziert werden. Weitere Informationen finden Sie im Internet unter „Verträglichkeit der Beständigkeit gegen Polypropylen-Chemikalien“. Die Verwendung dieser Substanzen hängt auch von der Temperatur, dem Druck und der Konzentration ab. Es ist immer eine gute Praxis, nach dem Desinfizieren der Technopolymerprodukte mit diesen Substanzen die Produkte sofort mit Wasser zu spülen. Es sollte zudem nicht mit Schleif- bzw. Lösungsmittel in Kontakt treten oder mit grobe Reinigungsgeräte. Die auf die Produkte Gaber® verschütteten Flüssigkeiten müssen sofort abgetrocknet werden. Produkte, die für den Außenbereich bestimmt sind, erleiden mit der Zeit die wetterbedingten Einwirkungen. Eventuelle oberflächliche Änderungen können aufgrund bestimmter Temperatur-, Feuchtigkeits- oder Salzgehaltsbedingungen auftreten. Eine direkte Sonneneinstrahlung kann eine Farbänderung des Produktes verursachen. Eine korrekte und regelmäßige Wartung und Reinigung erhöht die Haltbarkeit des Produkts. Wartungsmaßnahmen sollten von einem spezialisierten Personal vorgenommen werden. Die Kappen und Schutzvorrichtungen der Gaber®-Produkte sind in einer Gummimischung mit hoher Verschleißfestigkeit gemacht, zur Reduzierung von Schleppgeräuschen. Einige Gaber®-Produkte sind Filzstößeln ausgestattet, die für starre und empfindlichere Böden geeignet sind.

Gaber® realisiert auf Anfrage einige Produkte der eigenen Kollektion mit feuerfesten „Tecnopolymer“: die Zusatzstoffe, die das Kunststoffmaterial feuerfest machen, können die Ästhetik und die Resistenz der Produkte grundlegend verändern.

Die Kappen und Schutzvorrichtungen der Gaber-Produkte sind in einer Gummimischung mit hoher Verschleißfestigkeit gemacht, zur Reduzierung von Schleppgeräuschen. Einige Gaber-Produkte sind Filzstößeln ausgestattet, die für starre und empfindlichere Böden geeignet sind.

Der Stahl

Bei den Strukturen von Tischen, Stühlen und Hockern wird hochfester Stahl verwendet, diese werden von Gaber® mittels rund- bzw. quadratförmige Röhre realisiert. Die Produkte sind in verchromter oder lackierter Ausführung erhältlich. Die spezielle Lackierung aus Epoxidpulver, die von Gaber® an vielen Strukturen verwendet wird, erreicht eine optimale Resistenz gegen die atmosphärischen Einflüsse.

Das Aluminium

Gaber® benutzt das Aluminium für die Realisierung der Strukturen von Tischen, Stühlen und Hockern. Mittels einer speziellen Verarbeitung der Oberflächen einiger Produkte Gaber®, des Anodisieren, wird die Korrosionsresistenz erhöht. Richtlinien für die korrekte Verwendung: sowohl die Stahl- als auch die Aluminiumoberflächen müssen mit einem feuchten und weichen Tuch, durchtränkt in heißem Wasser, gereinigt werden. Für die hartnäckigsten Flecken kann man mit Vorsicht eine neutrale flüssige Seife in Wasser verdünnen. Nach der Reinigung sollte die Oberfläche immer mit einem weichen Tuch abgetrocknet werden. Verwenden Sie keine Cremes oder Pasten um die Metalle zu reinigen, sowie kein Chlor, Bleichmittel oder sonstige aggressive Reinigungsmittel. Benutzen Sie auch keine groben Pasten oder schleifende Schwämme, die die Metalloberflächen verkratzen könnten.

Das Holz

Die Produkte Gaber® mit Holzelemente werden in Übereinstimmung mit den geltenden europäischen Vorschriften bezüglich der Emission von Formaldehyd hergestellt. „Compound-Wood“ ist das besondere Material, das von Gaber® für die Realisierung der Produkte „Alhambra-Eco“ und „Epica-Eco“, verwendet wird. Dieses Material benutzt die Holzfasern aus dem Produktionsprozess, mit welchem Gaber® die Holzelemente herstellt. Es wird nichts verschwendet. Richtlinien für die korrekte Verwendung: Die Holzoberfläche kann mit der Zeit durch die Benutzung oder die Sonneneinstrahlung eine Farbänderung erleiden, da es sich um ein natürliches Material handelt. Zudem sind die Oberflächen, aufgrund Ihrer Natur, leicht zu beschädigen. Einige kleine Unreinheiten und Macken liegen im annehmbaren Qualitätsstandard. Die Holzoberflächen vertragen keine direkte Wärmezufuhr. Reinigen Sie die Holzoberflächen mit einem feuchten und weichen Tuch, durchtränkt in lauwarmes Wasser. Trocknen Sie das Produkt sofort nach der Reinigung.

Polsterung in flexibles Polyurethan

Die Polsterung einiger Produkte von Gaber® besteht aus flexiblem Polyurethan, kaltgepresst, ohne CFC/HCFC (ODP=0: es trägt nicht zur Reduzierung der atmosphärischen Ozonschicht bei), selbstlöschend der Klasse 1-IM UNI 9175/CMHR, gemäß der geltenden europäischen Vorschriften.

Die Bezüge: Stoffe und Leder

Gaber® verwendet Stoffe und Leder, die zu einer umfassenden Palette an Farben und Mustern gehören, die alle aus einer Reihe getesteter Produkte ausgewählt wurden, mit dem Ziel die beste Leistung wie die Abriebfestigkeit und Resistenz gegen künstliches Lichtes zu erzielen. Es sind Kategorien feuerfester Stoffe und künstliche Lederbezüge erhältlich. Richtlinien für die korrekte Verwendung: Reinigen Sie das Leder mit einem weißen Tuch, der nur mit Wasser befeuchtet werden sollte.

VERPACKUNG UND RECYCLING

Unsere Verpackungen wurden mit dem Ziel realisiert den Lager und Transport zu optimieren. Sie bestehen zu 90% aus recycelten Materialien und sind vollständig recycelbar. Die Optimierung der Verpackung in Bezug auf Volumen und Gewicht führt zu einem geringeren Energieverbrauch, mit einer folgenden Einsparung bei den Transportkosten und einer wichtige Hilfe zum Schutz der Umwelt. Um den Verlust von Bauteilen zu vermeiden, wird es empfohlen die Verpackung erst nach Abschluss der Montage der Produkte zu entsorgen. Nach der Montage kann das Produkt oder seine Bestandteile dem öffentlichen Entsorgungssystem gemäß den geltenden örtlichen Vorschriften übergeben werden.

UNSACHGEMÄSSE VERWENDUNG DES PRODUKTS

Als eine unpassende bzw. unkorrekte Verwendung des Produkts wird folgendes angesehen: auf Tische, Stühle und Hockern aufstehen, auf Rücken- und Armlehnen niedersetzen, die Produkte als Treppchen zu nutzen. Das Schwenken des Produktes könnte das Produkt oder dessen Funktion beschädigen und die Sicherheit des Nutzers gefährden. Um das Produkt anzuheben oder zu verschieben wird empfohlen es an der Hauptstruktur und nicht unter dem Sitz zu halten. Das Produkt sollte keiner dezentralen Last ausgesetzt sein, da es für die Nutzung in normalen Konditionen geplant wurde. Gaber® übernimmt keine Haftung für Schäden an Sachen oder Personen, die durch unsachgemäße Verwendung des Produkts verursacht wurden. Gaber® lehnt zudem jede Haftung für Schäden an empfindlichen Böden oder Oberflächen ab.



CONTENTS / INDICE CHAIRS

DAME

P.96

Forsix Design



CUCARACHA

P.93

Favaretto & Partners Design

[NEW]



MANAA

P.164

Studio Eurolinea Design



CHOPPY

P.79 CHEVALET

P.78

Favaretto & Partners Design

Favaretto & Partners Design



NUTA LIGHT

P.182 KASIA

P.157

Favaretto & Partners Design

[NEW] Forsix Design

[NEW]



CHAIRS

FULLER P.118 ARTESIA P.62



JUBEL P.126



KANVAS P.135



EPICA P.108 TOGETHER P.215 LILÁ P.160



NUTA P.180 ABUELA P.44



CHAIRS

ISIDORA P.124 LILIBET P.161



SPYKER P.210 CLIPPERTON P.82



BAKHITA P.66 MINUSH P.226 PRISMA P.196



SANELA P.198



AMITHA P.58



CHAIRS

LINK Stefano Sandonà Design		P.162 AVENICA Studio Eurolinea Design			P.65
					
KALIPA Studio Eurolinea Design		P.134 PANAMA Stefano Sandonà Design		P.185 BIG BANG Stefano Sandonà Design	
					
BLOG Stefano Sandonà Design		P.76 AKAMI Stefano Sandonà Design			P.46
					
COLORFIVE Stefano Sandonà Design		P.85 ALHAMBRA Stefano Sandonà Design			P.53
					
SLOT Favaretto & Partners Design					P.201
					

CHAIRS

BASKET Forsix Design			P.68 MOEMA Forsix Design		P.170
					
MORE Favaretto & Partners Design		P.175 EXTREME Forsix Design		P.114 FLAP Studio Eurolinea Design	
					
ELODIE Marc Sadler Design		P.106 TECKEL Studio Eurolinea Design		P.213 NINJA Delineo Design	
					
HARMONY Studio Eurolinea Design		P.121 IRIS Studio Eurolinea Design		P.123 MOON - VENEZIA Forsix Design	
					
OVER Forsix Design		P.184 LIBERTY Forsix Design		P.159 OPEN Forsix Design	
					
		P.183 SERENA Forsix Design		P.200	

CHAIRS

MAYA P.168 TULIP P.216 BEVERLY P.74

Forsix Design Forsix Design Forsix Design



LOUNGE SEATING, SOFAS, POUF

MINUSH RELAX P.169 GRAND MINUSH P.120 CONGA P.91

Studio Eurolinea Design Studio Eurolinea Design Studio Eurolinea Design



ETESIAN P.110

Forsix Design

[NEW]



LOUNGE SEATING, SOFAS, POUF

SANELA P.198

Forsix Design

[NEW]



SOCIAL-IZE P.209 PANKY P.187

Studio Eurolinea Design Forsix Design



AMITHA P.60

Forsix Design

[NEW]



PLACE P.193

Favaretto & Partners Design



LINK P.162 SUNLOUNGER P.211

Stefano Sandonà Design

Forsix Design



EALA P.104 KANVAS LOUNGE P.156

Forsix Design

[NEW] Stefano Sandonà Design



SLOT LOUNGE

Favaretto & Partners Design



P.208 ABUELA LOUNGE

Favaretto & Partners Design



CUCARACHA

Favaretto & Partners Design



P.93 FINFERLO

[NEW] Favaretto & Partners Design

P.115

NUTA LIGHT

Favaretto & Partners Design



P.272 KASIA

[NEW] Forsix Design



P.257

[NEW]

SANELA

Forsix Design



P.281 AMITHA

[NEW] Forsix Design



P.227 LINK

Stefano Sandonà Design



ABUELA

Favaretto & Partners Design

P.220 NUTA

Favaretto & Partners Design

P.271



ISIDORO

Favaretto & Partners Design

P.247 BAKHITA

Studio Eurolinea Design

P.231 SPYKER

Studio Eurolinea Design

P.288



FULLER

Marc Sadler Design



P.245 JUBEL

Forsix Design









P.250



STOOLS

KANVAS Stefano Sandonà Design		P.254 ARTESIA Forsix Design			P.228		
							
COLORFIVE Stefano Sandonà Design		P.235 ALHAMBRA Stefano Sandonà Design		P.223 PRODIGE Delineo Design		P.278	
							
BLOG Stefano Sandonà Design		P.232 AKAMI Stefano Sandonà Design		P.221 MOEMA Stefano Sandonà Design		P.268 [NEW]	
							
MORE Favaretto & Partners Design		P.269 MANAA Studio Eurolinea Design		P.263 DAME Forsix Design		P.238 [NEW]	
							
SLOT Favaretto & Partners Design		P.283 PANAMA Stefano Sandonà Design		P.276 KALIPA Studio Eurolinea Design		P.253	
							

STOOLS

EASY Studio Eurolinea Design		P.240 LILÁ Forsix Design		P.260 SHIVER Studio Eurolinea Design		P.282 ROLLER Studio Eurolinea Design		P.280			
											
MOEMA Stefano Sandonà Design		P.267 OCTO Stefano Sandonà Design		P.273 FREEDOM Stefano Sandonà Design		P.244 RITMO Forsix Design		P.279 FORMAT Forsix Design		P.242	
											
MAX Forsix Design		P.265 CROSS Forsix Design		P.237 SWING - TORINO Stefano Sandonà Design		P.290 - 292		SQUARE Forsix Design		P.289	
											
MICRO Studio Eurolinea Design		P.266 OVER Forsix Design		P.275 ASOLO Forsix Design		P.230 SNACK · CITRO Forsix Design		P.287-234			
											
FIX · TOM · JOY Studio Eurolinea Design		P.241-291-249		GULIVER · FREE Forsix Design		P.246-243					
											

STOOLS

LIBERTY P.259 OFER P.274

Forsix Design Forsix Design



TABLES

COFFEE TABLES_H35/50

TAG P.357 SURFY P.355 SURFY P.356

Ilaria Marelli Design **[NEW]** Studio Eurolinea Design Studio Eurolinea Design



STEFANINO P.345 STEFANO 3-POD P.344 WOODY P.361 SATURNINO P.339 ROLLER P.333

Studio Eurolinea Design Studio Eurolinea Design Favaretto & Partners Design Studio Eurolinea Design Studio Eurolinea Design



ARKET P.296 LOL3 P.318 LINK P.317 SIMPLY P.340 MINUSH P.322

Studio Eurolinea Design Forsix Design Stefano Sandonà Design Studio Eurolinea Design Studio Eurolinea Design



CLARO P.303 CLARO SLIM P.306

Studio Eurolinea Design Studio Eurolinea Design



TABLES

HIGH TABLES_H100/110

SURFY HIGH DESK 2027 P.353 STEP P.346 FORMAT P.310 BASKET P.300 ICS P.315
 Studio Eurolinea Design Studio Eurolinea Design Studio Eurolinea Design Studio Eurolinea Design Studio Eurolinea Design



AZIONE Forsix Design P.299 CLARO SLIM Studio Eurolinea Design P.308 SIMPLY Studio Eurolinea Design P.340 TOGETHER Marc Sadler Design P.360 NORMAN Forsix Design P.324 [NEW]



GLITTER Forsix Design P.311 ARKET [NEW] Studio Eurolinea Design P.296 LEI Studio Eurolinea Design P.400 TKITT Studio Eurolinea Design P.363 TATAMI Studio Eurolinea Design P.409



SERIE R Studio Eurolinea Design P.403 - 404 SERIE Q Studio Eurolinea Design P.405 - 406 ROLLER Studio Eurolinea Design P.336



TABLES

TABLES_H74

APRIO Forsix Design P.295 CLARO [NEW] Studio Eurolinea Design P.303 CLARO SLIM Studio Eurolinea Design P.307



SIMPLY Studio Eurolinea Design P.340 ROLLER Studio Eurolinea Design P.336 MUG Studio Eurolinea Design P.323 SATURNO Studio Eurolinea Design P.338 TKITT Studio Eurolinea Design P.363



GLITTER Forsix Design P.311 ARKET [NEW] Studio Eurolinea Design P.296 ARKET PLUS Studio Eurolinea Design P.298



BRISTOL Forsix Design P.301 LOL [NEW] Forsix Design P.318 LOL PLUS Forsix Design P.319



LEI Studio Eurolinea Design P.213 HUG Studio Eurolinea Design P.312 AMICA Studio Eurolinea Design P.215 NORMAN Forsix Design P.324 LOGIN [NEW] Studio Eurolinea Design P.317



TABLES

TABLES_H74

PAREO P.327 AGILE P.294 CHARME P.302

Studio Eurolinea Design [NEW] Studio Eurolinea Design Studio Eurolinea Design



SURFY HUB 2027 P.348 SURFY DESK 2027 P.352 SURFY HUB 2027 OVAL P.350

Forsix Design Forsix Design Forsix Design



FLIPAWAY P.309 AZIONE P.299 FORMAT P.310 PROFILO P.332 SPACE P.341

Forsix Design Forsix Design Studio Eurolinea Design Studio Eurolinea Design Studio Eurolinea Design



STEFANO P.342 TOGETHER P.359

Studio Eurolinea Design Marc Sadler Design



TABLES

TKITT COLLECTION

TKITT.BG3K P.365 TKITT.BG3L P.366 TKITT.BG4IP P.369 TKITT.BG4J P.368 TKITT.BG4K P.367



TKITT.BGA3L P.366 TKITT.BGA4K P.367 TKITT.BGPJ P.369 TKITT.BGPK P.368 TKITT.DPBT54 P.372



TKITT.BQAJ P.373 TKITT.BQJ P.373 TKITT.BRK P.372 TKITT.BTAK P.370 TKITT.BTAK54 P.371



TKITT.BTK P.370 TKITT.BTK54 P.371 TKITT.STAKY P.374 TCONT.STADY P.375

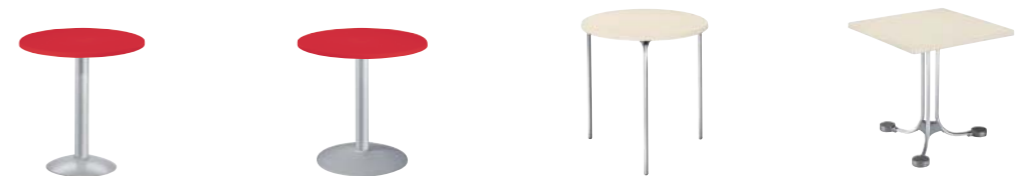

TABLES

TABLE TOPS

STANDARD COMPACTOP SURFACES P.376 SPECIAL COMPACTOP SURFACES FULLCOLOR P.377 SPECIAL COMPACTOP SURFACES 10 P.378 SPECIAL COMPACTOP SURFACES FENIX P.380 STANDARD LAMINATED SURFACES 22 P.381



STANDARD LAMINATED SURFACES 50 P.382 SPECIAL LAMINATED SURFACES WOOD EFFECT 25 P.383 SPECIAL LAMINATED SURFACES FENIX 25 P.384 IRON SURFACES P.385 TECHNO POLYMER TABLE TOPS P.386



TABLES

TABLE BASES COLLECTION

ALFIE P.408 AMICA P.402 ARKET PLUS P.389 ARKET 3 P.388



ARKET 4 P.388 BG2J P.395 BG3K - BGA3K P.389 - 390 BG3L - BGA3L P.391



BG4IP P.395 BG4J P.393 BG4K - BGA4K P.392 BGPJ P.394 BGPK P.393



BPG3K P.390 BPG4K P.394 BQAJ - BQJ P.400 - 401 BRCV P.398 BRISTOL P.413 [NEW]



BRK P.399 BTAK - BTK P.396 BTAK54 - BTK54 P.397 D2 P.407 GLITTER P.414 [NEW]



TABLES

TABLE BASES COLLECTION

LEI P.400 LOL PLUS P.412 LOL 3 P.410 LOL 4 P.411



Q1 - Q2 - Q3 P.405 - 406 R1 - R2 - R3 P.403 - 404



T1 FLOOR FIXING P.405 TATAMI P.409 V1 P.404 VENUS ROUND P.398 VENUS SQUARE P.399



CABINETS & WORKSTATION

OFFICE & WORKSPACES SYSTEMS

WORKSTATIONS 2027 P.416

Forsix Design

[NEW]



CABINETS 2027 P.424

Forsix Design

[NEW]



DIAMANTE Studio Eurolinea Design P.437 TUNE Forsix Design P.444 PIUMA Studio Eurolinea Design P.442



STILLY Studio Eurolinea Design P.432 FONO Marc Sadler Design P.433



MADISON Studio Eurolinea Design P.436 UNIKO Studio Eurolinea Design P.435



ONDA Studio Eurolinea Design P.448 FLAIRE Studio Eurolinea Design P.450 LUX Studio Eurolinea Design P.451 CULTURE Malene Flønsted Urup Design P.449 DISPLAY [NEW] Malene Flønsted Urup Design P.429 [NEW]



COLORS AND FINISHES P.454















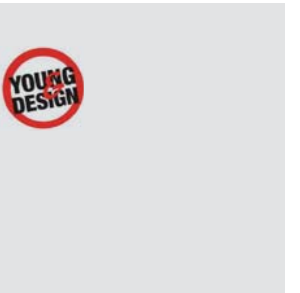

AWARDS

SUCCESS IN PROGRESS

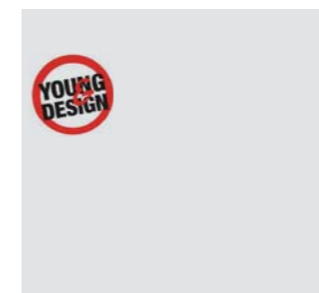

Gaber has won prestigious awards in the field on innovation and design. These recognitions are a testament to Gaber's unstinting commitment to design and the focus on originality and innovation we bring to the world.

Gaber ha vinto prestigiosi riconoscimenti nel campo dell'innovazione e del design. Questi riconoscimenti sono una testimonianza dell'impegno incondizionato di Gaber per il design e l'attenzione all'originalità e all'innovazione che portiamo al mondo.

 <p>MAGIC 2003 Studio Eurolinea Design</p> 	 <p>OVER 2004 Studio Eurolinea Design</p> 	 <p>PRISMA 2005 Studio Eurolinea Design</p> 	 <p>PRODIGE 2007 Delineo Design</p> 
 <p>FLOWER 2008 Laura Tombari Design</p> 	 <p>SPRING 2008 Monica Graffeo Design</p> 	 <p>EXTREME 2009 Stefano Sandonà Design</p> 	 <p>MOEMA 2009 Stefano Sandonà Design</p> 

AWARDS

SUCCESS IN PROGRESS



ALHAMBRA
2010
Stefano
Sandona
Design



FREEDOM
2010
Stefano
Sandona
Design

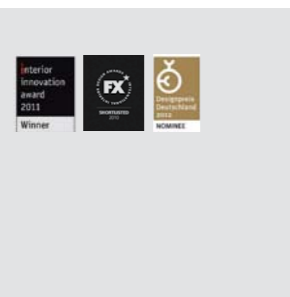

BIG BANG
2011
Stefano Sandona
Sabrina Bettini
Design



MOEMA wood
2011
Stefano
Sandona
Design

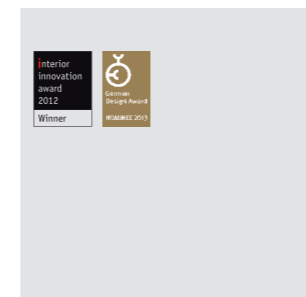

SLOT
2013
Favaretto &
Partners Design



CHEVALET
2013
Favaretto &
Partners Design



BASKET
2013
Alessandro
Busana
Design



EPICA
2014
Marc Sadler
Design



JOE
2011
Stefano
Sandona
Design



COLORFIVE
2011
Stefano
Sandona
Design



TOGETHER
2011
Marc Sadler
Design



BLOG
2012
Stefano
Sandona
Design

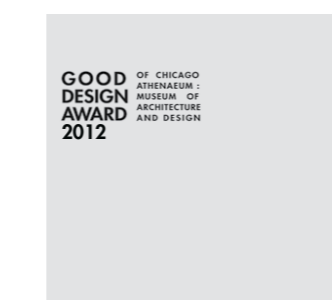

STILLY
2014
Studio Eurolinea
Design



**ISIDORA
ISIDORO**
2015
Favaretto &
Partners Design



CHOPPY
2015
Favaretto &
Partners Design

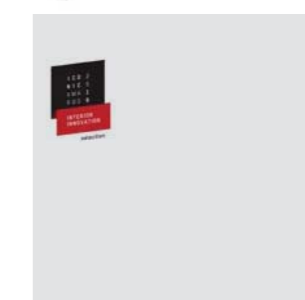

AVENICA
2016
Studio Eurolinea
Design



OCTO
2012
Stefano
Sandona
Design



MORE
2012
Favaretto &
Partners Design

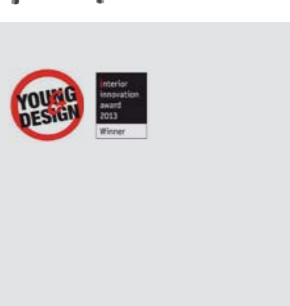

PANAMA
2013
Stefano
Sandona
Design

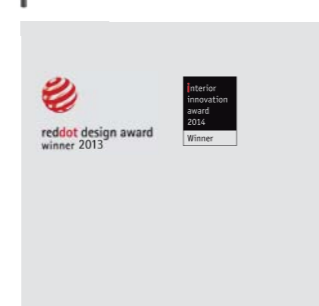

AKAMI
2013
Stefano
Sandona
Design

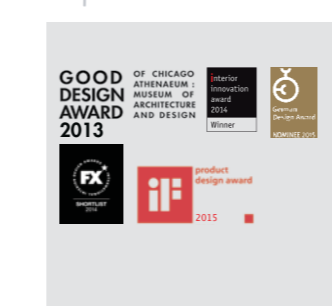

PLACE
2016
Favaretto &
Partners Design



DIAMANTE
2016
Studio Eurolinea
Design

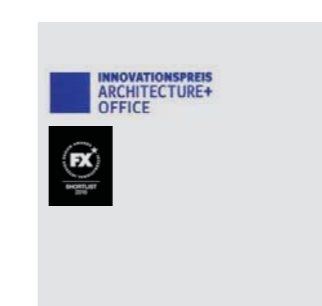

ELODIE
2016
Marc Sadler
Design



CLIPPERTON
2017
Marc Sadler
Design



AWARDS



ABUELA
2018
Favaretto &
Partners Design



SPYKER
2018
Studio Eurolinea
Design

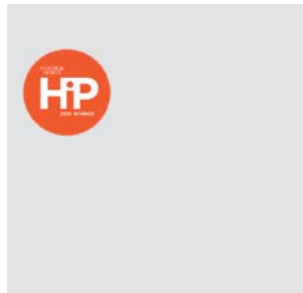

JUBEL
2019
Forsix Design



FULLER
2019
Marc Sadler
Design



CUCARACHA
2019
Favaretto &
Partners Design



**SUNLOUNGER
DOGE**
2019
Forsix Design



NUTA
2019
Favaretto &
Partners Design



AMITHA
2021
Forsix Design



ARTESIA
2021
Forsix Design



SEATING Collection

Abuela



Available colors / Colori disponibili

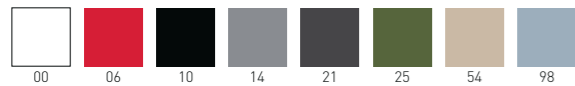

ABUELA



4-legged stackable techno-polymer chair.
Sedia impilabile in tecnopolimero.



stackable / impilabile (6pcs)

A assembled / assemblato



Frame Finishing & Codes / Finiture Telai e Codici

cod.292.--/A

€ 148,00

ABUELA B



4-legged stackable techno-polymer chair with armrests.
Sedia impilabile in tecnopolimero con braccioli.

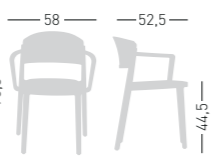

stackable / impilabile (6pcs)

A assembled / assemblato

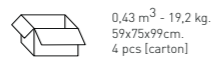

Frame Finishing & Codes / Finiture Telai e Codici

cod.293.--/A

€ 168,00

ABUELA CUSHION / CUSCINO



Upholstered cushion.
Cuscino tappezzato.

Available fabric.
Tessuti disponibili.
K, B, E, DK, TC



0,5 kg.
Inside chairs boxes
Nella scatola delle sedie.

Frame Finishing & Codes / Finiture Telai e Codici

cod.321.-- (K)

cod.321.-- (E)

cod.321.-- (B)

cod.321.-- (DK)

cod.321.TC COM fabric/tessuto cliente

€ 51,00

€ 51,00

€ 55,00

€ 63,00

€ 44,00

Minimum order 4pcs each code
Ordine minimo 4 pezzi per codice

COM fabric minimum order 10pcs each code
Tessuto cliente TC ordine minimo 10pz per codice

Fabric required / Fabbisogno di tessuto
4 pcs : Lin Mtrs 1 (h1,40)

ABUELA UPHOLSTERED IMBOTTITE

Available fabric / Tessuti disponibili
King fabric / Tessuto King K (20pcs min.)
Kvadrat fabrics / Tessuti Kvadrat - Remix 3 DK (20pcs min.)

Steelcut 2 Fabric not available on this product
Tessuto Steelcut 2 non disponibile per questo prodotto

ABUELA WOOD



Upholstered chair, wooden beech frame.
Poltroncina rivestita, telaio in legno di faggio.

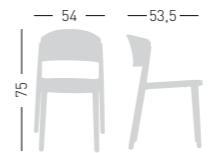

A assembled / assemblato



Frame Finishing & Codes / Finiture Telai e Codici

cod.295.--/IKBLF

cod.295.--/IDKBLF

€ 1.240,00

€ 1.356,00

Felt Glides / Tappi in feltro

Minimum order 20 pcs each code
Ordine minimo 20 pezzi per codice

ABUELA LOUNGE WOOD



Upholstered lounge chair, wooden beech frame.
Poltrona rivestita, telaio in legno di faggio.

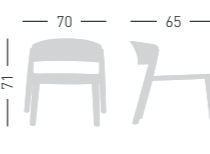

A assembled / assemblato



Frame Finishing & Codes / Finiture Telai e Codici

cod.296.--/IKBLF

cod.296.--/IDKBLF

€ 1.630,00

€ 1.790,00

Felt Glides / Tappi in feltro

Minimum order 20 pcs each code
Ordine minimo 20 pezzi per codice



Available colors / Colori disponibili

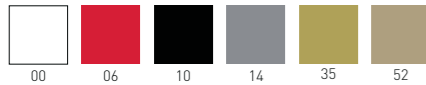

IGN Versions follows UNI 9177 certification in terms of Fire Resistance, Fire Reaction Class 1
Versioni IGN prodotto Omologato con Classe di Reazione al fuoco 1, UNI 9177



AKAMI NA



Chromed or painted 4-Legged metal frame, techno-polymer shell.
Struttura in metallo 4 gambe, cromata o verniciata, scocca in tecnopolimero.



only for painted frames
solo per telai verniciati

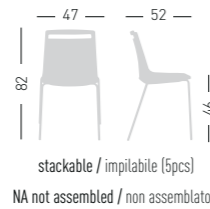

stackable / impilabile (5pcs)
NA not assembled / non assemblato



Frame Finishing & Codes / Finiture Telai e Codici

cod.191.--/NA chromed/cromata
cod.191.--/NAB white painted/verniciato bianco
cod.191.--/NAN black painted/verniciato nero

€ 192,00
€ 222,00
€ 222,00

cod.191.--/IGNNA
fire retardant, chromed frame
ignifuga, telaio cromato
Minimum order 300pcs/ Ordine minimo 300pz

€ 156,00

AKAMI TB



Chromed or painted 4-Legged metal frame with armrests, techno-polymer shell.
Struttura in metallo 4 gambe con braccioli, cromata o verniciata, scocca in tecnopolimero.



only for painted frames
solo per telai verniciati

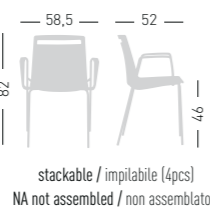

stackable / impilabile (4pcs)
NA not assembled / non assemblato



Frame Finishing & Codes / Finiture Telai e Codici

cod.191.--/TB chromed/cromata
cod.191.--/TBB white painted/verniciato bianco
cod.191.--/TBN black painted/verniciato nero

€ 244,00
€ 268,00
€ 268,00

Armrest white for shells cod. 00-42-52
Armrest black for shells cod. 06-10-14
Bracciolo bianco per scocche cod. 00-42-52
Bracciolo nero per scocche cod. 06-10-14

In case of painted frame, armrests color are combined with frame colors.
Nel caso di telai verniciati, il colore dei braccioli segue il colore dei telai.

AKAMI S



Chromed or painted wire steel sled frame, techno-polymer shell.
Struttura a slitta in filo, cromata o verniciata, scocca in tecnopolimero.



only for painted frames
solo per telai verniciati

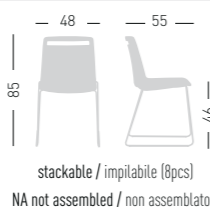

stackable / impilabile (8pcs)
NA not assembled / non assemblato



Frame Finishing & Codes / Finiture Telai e Codici

cod.191.--/S chromed/cromata
cod.191.--/SB white painted/verniciato bianco
cod.191.--/SN black painted/verniciato nero

€ 192,00
€ 222,00
€ 222,00

AKAMI SS



Chromed or white painted wire steel sled frame with armrests, techno-polymer shell.
Struttura a slitta in filo con braccioli, cromata o verniciata bianca, scocca in tecnopolimero.



only for painted frames
solo per telai verniciati

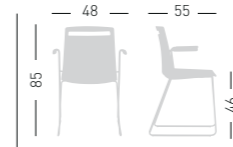

stackable / impilabile (8pcs)
NA not assembled / non assemblato



Frame Finishing & Codes / Finiture Telai e Codici

cod.191.--/SS chromed/cromata
cod.191.--/SSB white painted/verniciato bianco

€ 244,00
€ 268,00

The arm pads are in the same color of the shell
Il copribraziolo è dello stesso colore della scocca

AKAMI BL



4-Legged wooden beech frame, techno-polymer shell.
Struttura in legno di faggio 4 gambe, scocca in tecnopolimero.



only for painted frames
solo per telai verniciati

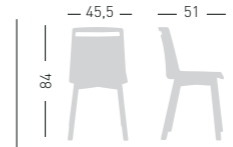

NA not assembled / non assemblato

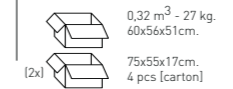

Frame Finishing & Codes / Finiture Telai e Codici

cod.191.--/BLF

€ 460,00

Felt Glides / Tappi in feltro

AKAMI T5R



Swivel on 5-blade polished aluminum base with castors, height adjustable, techno-polymer shell.
Girevole su basamento 5 razze in alluminio pulito con ruote, regolabile in altezza, scocca in tecnopolimero.

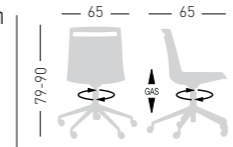

NA not assembled / non assemblato



Frame Finishing & Codes / Finiture Telai e Codici

cod.191._/T5R polished/pulita

€ 402,00

AKAMI T5R BRACCIOLO



Swivel on 5-blade polished aluminum base with castors, height adjustable, techno-polymer shell, armrests.
Girevole su basamento 5 razze in alluminio pulito con ruote, regolabile in altezza, scocca in tecnopolimero, braccioli.

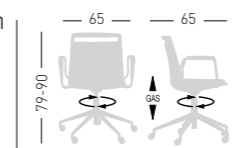

NA not assembled / non assemblato



Frame Finishing & Codes / Finiture Telai e Codici

cod.191._/T5RB polished/pulita

€ 440,00

Armrest white for shells cod. 00-35-52
Armrest black for shells cod. 06-10-14
Bracciolo bianco per scocche cod. 00-35-52
Bracciolo nero per scocche cod. 06-10-14

AKAMI U



Techno-polymer shell, swivel on 4-blade aluminum painted base.
Scocca in tecnopolimero, girevole su basamento verniciato in alluminio a 4 razze.

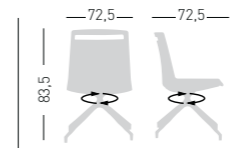

NA not assembled / non assemblato

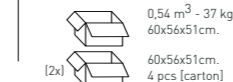

Frame Finishing & Codes / Finiture Telai e Codici

cod.191.--/UB white/bianca
cod.191.--/UN black/nera

€ 396,00
€ 396,00

Felt Glides / Tappi in feltro

AKAMI UR



Techno-polymer shell, swivel on 4-blade aluminum painted base, with castors.
Scocca in tecnopolimero, girevole su basamento verniciato in alluminio a 4 razze, su ruote.

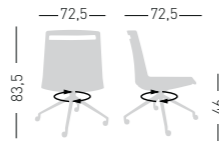

NA not assembled / non assemblato

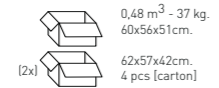

Frame Finishing & Codes / Finiture Telai e Codici

cod.191.--/URB white/bianca
cod.191.--/URN black/nera

€ **410,00**
€ **410,00**

AKAMI U BR



Techno-polymer shell, swivel on 4-blade aluminum painted base, armrests.
Scocca in tecnopolimero, girevole su basamento verniciato in alluminio a 4 razze, braccioli.

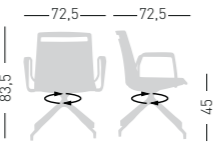

NA not assembled / non assemblato



Frame Finishing & Codes / Finiture Telai e Codici

cod.191.--/UBB white/bianca
cod.191.--/UNB black/nera

€ **436,00**
€ **436,00**

Armrests and base colours are combined
I colori di braccioli e base sono combinati
Felt Glides / Tappi in feltro

AKAMI UR BR



Techno-polymer shell, swivel on 4-blade aluminum painted base, with castors and armrests.
Scocca in tecnopolimero, girevole su basamento verniciato in alluminio a 4 razze su ruote, braccioli.

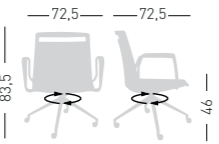

NA not assembled / non assemblato

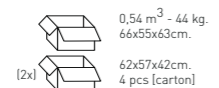

Frame Finishing & Codes / Finiture Telai e Codici

cod.191.--/URBB white/bianca
cod.191.--/URNB black/nera

€ **448,00**
€ **448,00**

Armrests and base colours are combined
I colori di braccioli e base sono combinati

AKAMI PG



2-3-4-5 seat benches, metal-polymer co-injected legs, techno-polymer shell.
Panca a 2-3-4-5 posti, gambe co-iniettate in metallo-polimero, scocca in tecnopolimero.

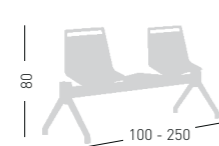

NA not assembled / non assemblato

Frame Finishing & Codes / Finiture Telai e Codici

cod.191.--/PG2P-- (100 cm) € **636,00**
cod.191.--/PG3P-- (150 cm) € **740,00**
cod.191.--/PG4P-- (200 cm) € **840,00**
cod.191.--/PG5P-- (250 cm) € **942,00**

Bench legs available colors: 00-06-10-13-14-33-34-42
It is possible to change a seat with a grey metal top.
Outdoor version on request.
Colori disponibili gambe panca: 00-06-10-13-14-33-34-42
È possibile sostituire la seduta con un tavolino grigio in metallo. Versione per esterni su richiesta.

AKAMI CUSHION / CUSCINO



Cushion available in eco-leather aurea, King, Fenice and Kvadrat fabrics.
Cuscino in ecopelle aurea, tessuti King, Fenice e Kvadrat.



Frame Finishing & Codes / Finiture Telai e Codici

cod.305.-- (B) € **124,00**
cod.305.-- (E) € **106,00**
cod.305.-- (K) € **106,00**
cod.305.-- (DK) € **130,00**
cod.305.TC COM fabric/tessuto cliente € **92,00**

Minimum order 4pcs each code
Ordine minimo 4 pezzi per codice
COM fabric minimum order 10pcs each code
Tessuto cliente TC ordine minimo 10pz per codice
Fabric required / Fabbisogno di tessuto
4 pcs : Lin Mtrs 1 (h1,40)

Available fabric.
Tessuti disponibili.
B, E, K, DK
COM fabric / Tessuto cliente **TC**

AKAMI CONNECTING SYSTEM GANCIO CONNESSIONE



Extensible chromed linking devices for in-line disposal.
Agganci estensibili cromati per disporre le sedute in linea.

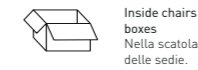

Frame Finishing & Codes / Finiture Telai e Codici

cod.1004

€ **44,00**

available for models: NA, TB, S, SS, SST
disponibile per versioni: NA, TB, S, SS, SST

AKAMI CONNECTING SYSTEM GANCIO CONNESSIONE



Set linking glides for in-line disposal.
Set piedini con agganci per disporre le sedute in linea.

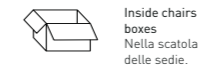

Frame Finishing & Codes / Finiture Telai e Codici

cod.1014

€ **20,00**

available for models: S, SST
disponibile per versioni: S, SST

Assembled / assemblato

AKAMI CHAIRS TROLLEY CARRELLO PER SEDIE



Trolley for chairs, chromed metal structure.
Carrello porta sedie, struttura in metallo cromato.



Frame Finishing & Codes / Finiture Telai e Codici

cod.2000/A

€ **242,00**

available for models: S-SS
disponibile per versioni: S-SS

stackable on trolley 18 pcs
impilabili su carrello 18 pcs

max height with 18 chairs 188 cm
altezza carrello con 18 sedie 188 cm



AKAMI CHAIRS TROLLEY CARRELLO PER SEDIE



Painted grey adjustable Dolly, for 4 legged chairs.
Carrello per sedie 4 gambe, regolabile, verniciato grigio.

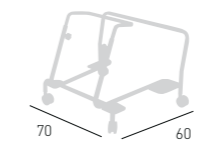

Frame Finishing & Codes / Finiture Telai e Codici

cod.2001/A

€ **290,00**

available for models: NA
disponibile per versioni: NA



AKAMI UPHOLSTERED IMBOTTITE

Products follows UNI 9175 -UNI 9175/FA, in terms of Fire Resistance, Fire Reation Class 11M
Prodotto Omologato dal Ministero dell'Interno, secondo la UNI 9175 -UNI 9175/FA, con classe di Reazione al fuoco 11M



Available coverings / Rivestimenti disponibili
Blazer fabric / Tessuto Blazer **B** (4pcs min.)
King fabric / Tessuto King **K** (4pcs min.)
Kvadrat fabrics / Tessuti Kvadrat **DK** (4pcs min.)
COM fabric / Tessuto cliente **TC** (10pcs min.)

AKAMI NA UPHOLSTERED



PU-Flex padded and upholstered shell, chromed or painted 4 legged metal frame.
Scocca imbottita in PU-Flex e rivestita, telaio 4 gambe in metallo cromato o verniciato.

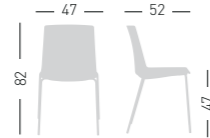

NA not assembled / non assemblato

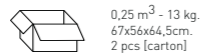

0,25 m³ - 13 kg.
67x56x64,5cm.
2 pcs (carton)

Frame Finishing & Codes / Finiture Telai e Codici

cod.191.--/IKNA chromed/cromata	€	426,00
cod.191.--/IKNAB white painted/verniciato bianco	€	458,00
cod.191.--/IKNAN black painted/verniciato nero	€	458,00
cod.191.--/IBNA chromed/cromata	€	456,00
cod.191.--/IBNAB white painted/verniciato bianco	€	486,00
cod.191.--/IBNAN black painted/verniciato nero	€	486,00
cod.191.--/IDKNA chromed/cromata	€	576,00
cod.191.--/IDKNAB white painted/verniciato bianco	€	608,00
cod.191.--/IDKNAN black painted/verniciato nero	€	608,00
cod.191./ITCNA chromed/cromata	€	370,00
cod.191./ITCNAB white painted/verniciato bianco	€	402,00
cod.191./ITCNAN black painted/verniciato nero	€	402,00

Fabric required
Fabbisogno di tessuto
1 pcs: Lin Mtrs 1,0 (h1,40)

COM fabric min. order
10pcs each code
Tessuto cliente TC ordine
min. 10pz per codice

Min. order 4pcs
each code
Ordine min 4pz
per codice

AKAMI TB UPHOLSTERED



PU-Flex padded and upholstered shell, chromed or painted 4 legged metal frame with armrests.
Scocca imbottita in PU-Flex e rivestita, telaio 4 gambe con braccioli in metallo cromato o verniciato.

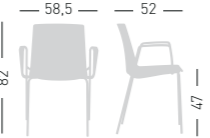

NA not assembled / non assemblato



0,31 m³ - 14 kg.
61x55x93cm.
2 pcs (carton)

Frame Finishing & Codes / Finiture Telai e Codici

cod.191.--/IKTB chromed/cromata	€	482,00
cod.191.--/IKTBB white painted/verniciato bianco	€	508,00
cod.191.--/IKTBN black painted/verniciato nero	€	508,00
cod.191.--/IBTB chromed/cromata	€	510,00
cod.191.--/IBTBB white painted/verniciato bianco	€	536,00
cod.191.--/IBTBN black painted/verniciato nero	€	536,00
cod.191.--/IDKTB chromed/cromata	€	632,00
cod.191.--/IDKTBB white painted/verniciato bianco	€	658,00
cod.191.--/IDKTNB black painted/verniciato nero	€	658,00
cod.191./ITCTB chromed/cromata	€	426,00
cod.191./ITCTBB white painted/verniciato bianco	€	454,00
cod.191./ITCTBN black painted/verniciato nero	€	454,00

Fabric required
Fabbisogno di tessuto
1 pcs: Lin Mtrs 1,0 (h1,40)

COM fabric min. order
10pcs each code
Tessuto cliente TC ordine
min. 10pz per codice

Min. order 4pcs
each code
Ordine min 4pz
per codice

Specify on the order the colour of the armrest: white or black
Specificare nell'ordine il colore del bracciolo: bianco o nero

AKAMI S UPHOLSTERED



PU-Flex padded and upholstered shell, chromed or painted wire steel sled frame.
Scocca imbottita in PU-Flex e rivestita, telaio slitta in filo metallo cromato o verniciato.

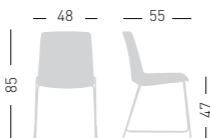

NA not assembled / non assemblato

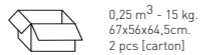

0,25 m³ - 15 kg.
67x56x64,5cm.
2 pcs (carton)

Frame Finishing & Codes / Finiture Telai e Codici

cod.191.--/IKS chromed/cromata	€	426,00
cod.191.--/IKSB white painted/verniciato bianco	€	458,00
cod.191.--/IKSN black painted/verniciato nero	€	458,00
cod.191.--/IBS chromed/cromata	€	456,00
cod.191.--/IBSB white painted/verniciato bianco	€	486,00
cod.191.--/IBSN black painted/verniciato nero	€	486,00
cod.191.--/IDKS chromed/cromata	€	576,00
cod.191.--/IDKSB white painted/verniciato bianco	€	608,00
cod.191.--/IDKSN black painted/verniciato nero	€	608,00
cod.191./ITCS chromed/cromata	€	370,00
cod.191./ITCSB white painted/verniciato bianco	€	402,00
cod.191./ITCSN black painted/verniciato nero	€	402,00

Fabric required
Fabbisogno di tessuto
1 pcs: Lin Mtrs 1,0 (h1,40)

COM fabric min. order
10pcs each code
Tessuto cliente TC ordine
min. 10pz per codice

Min. order 4pcs
each code
Ordine min 4pz
per codice

AKAMI SS UPHOLSTERED



PU-Flex padded and upholstered shell, chromed or painted wire steel sled frame with armrests.
Scocca imbottita in PU-Flex e rivestita, telaio in slitta in filo con braccioli cromato o verniciato.

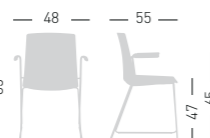

NA not assembled / non assemblato

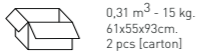

0,31 m³ - 15 kg.
61x55x93cm.
2 pcs (carton)

Frame Finishing & Codes / Finiture Telai e Codici

cod.191.--/IKSS chromed/cromata	€	484,00
cod.191.--/IKSSB white painted/verniciato bianco	€	510,00
cod.191.--/IBSS chromed/cromata	€	512,00
cod.191.--/IBSSB white painted/verniciato bianco	€	540,00
cod.191.--/IDKSS chromed/cromata	€	634,00
cod.191.--/IDKSSB white painted/verniciato bianco	€	660,00
cod.191./ITCSS chromed/cromata	€	430,00
cod.191./ITCSSB white painted/verniciato bianco	€	456,00

Fabric required
Fabbisogno di tessuto
1 pcs: Lin Mtrs 1,0 (h1,40)

COM fabric min. order
10pcs each code
Tessuto cliente TC ordine
min. 10pz per codice

Min. order 4pcs
each code
Ordine min 4pz
per codice

Specify on the order the colour of the armrest: white or black
Specificare nell'ordine il colore del bracciolo: bianco o nero

AKAMI BL UPHOLSTERED



4-Legged wooden beech frame, PU-Flex padded and upholstered shell.
Struttura in legno di faggio 4 gambe, scocca imbottita in PU-Flex e rivestita.

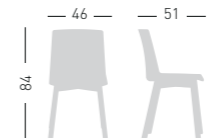

NA not assembled / non assemblato

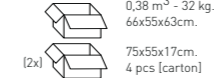

0,38 m³ - 32 kg.
66x55x63cm.
75x55x17cm.
4 pcs (carton)

Frame Finishing & Codes / Finiture Telai e Codici

cod.191.--/IKBLF	€	720,00
cod.191.--/IBBLF	€	748,00
cod.191.--/IDKBLF	€	870,00
cod.191.--/ITCBLF	€	662,00

Felt Glides / Tappi in feltro

Fabric required
Fabbisogno di tessuto
1 pcs: Lin Mtrs 1,0 (h1,40)

COM fabric min. order
10pcs each code
Tessuto cliente TC ordine
min. 10pz per codice

Min. order 4pcs
each code
Ordine min 4pz
per codice

AKAMI T5R UPHOLSTERED



PU-Flex padded and upholstered shell, swivel, height adjustable, polished aluminum base with castors.
Scocca imbottita in PU-Flex e rivestita, girevole, regolabile in altezza, base in alluminio pulito con ruote.

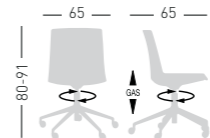

NA not assembled / non assemblato



0,25 m³ - 19,60 kg.
67x56x64,5cm.
2 pcs (carton)

Frame Finishing & Codes / Finiture Telai e Codici

cod.191._/IKT5R polished/pulita	€	610,00
cod.191._/IBT5R polished/pulita	€	638,00
cod.191._/IDKT5R polished/pulita	€	760,00
cod.191./ITCT5R polished/pulita	€	554,00

Fabric required
Fabbisogno di tessuto
1 pcs: Lin Mtrs 1,0 (h1,40)

COM fabric min. order
10pcs each code
Tessuto cliente TC ordine
min. 10pz per codice

Min. order 4pcs
each code
Ordine min 4pz
per codice

AKAMI T5R BRACCIOLO UPHOLSTERED



PU-Flex padded and upholstered shell, swivel, height adjustable, polished aluminum base with castors.
Scocca imbottita in PU-Flex e rivestita, girevole, regolabile in altezza, base in alluminio pulito con ruote.

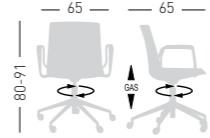

NA not assembled / non assemblato



0,25 m³ - 22 kg.
67x56x64,5cm.
2 pcs (carton)

Frame Finishing & Codes / Finiture Telai e Codici

cod.191._/IKT5RB polished/pulita	€	656,00
cod.191._/IBT5RB polished/pulita	€	684,00
cod.191._/IDKT5RB polished/pulita	€	804,00
cod.191./ITCT5RB polished/pulita	€	600,00

Fabric required
Fabbisogno di tessuto
1 pcs: Lin Mtrs 1,0 (h1,40)

COM fabric min. order
10pcs each code
Tessuto cliente TC ordine
min. 10pz per codice

Min. order 4pcs
each code
Ordine min 4pz
per codice

Specify on the order the colour of the armrest: white or black
Specificare nell'ordine il colore del bracciolo: bianco o nero

AKAMI U UPHOLSTERED



PU-Flex padded and upholstered shell, swivel on 4-blade aluminum painted base, with castors.
Scocca imbottita in PU-Flex e rivestita, girevole su basamento verniciato in alluminio a 4 razze.

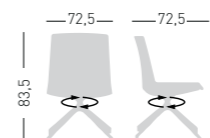

NA not assembled / non assemblato



0,60 m³ - 42 kg.
66x55x63cm.
60x56x51cm.
4 pcs (carton)

Frame Finishing & Codes / Finiture Telai e Codici

cod.191.--/IKUB white/bianca	€	650,00
cod.191.--/IKUN black/nera	€	650,00
cod.191.--/IKUL polished/lucida	€	676,00
cod.191.--/IBUB white/bianca	€	678,00
cod.191.--/IBUN black/nera	€	678,00
cod.191.--/IBUL polished/lucida	€	704,00
cod.191.--/IDKU white/bianca	€	798,00
cod.191.--/IDKUN black/nera	€	798,00
cod.191.--/IDKUL polished/lucida	€	826,00
cod.191./ITCUB white/bianca	€	594,00
cod.191./ITCUN black/nera	€	594,00
cod.191./ITCUL polished/lucida	€	620,00

Felt Glides / Tappi in feltro
Fabric required
Fabbisogno di tessuto
1 pcs: Lin Mtrs 1,0 (h1,40)

COM fabric min. order
10pcs each code
Tessuto cliente TC ordine
min. 10pz per codice

Min. order 4pcs
each code
Ordine min 4pz
per codice

AKAMI UR UPHOLSTERED



PU-Flex padded and upholstered shell, swivel on 4-blade aluminum painted base, with castors.
Scocca imbottita in PU-Flex e rivestita, girevole su basamento verniciato in alluminio a 4 razze, su ruote.

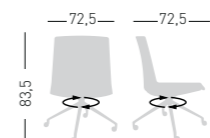

NA not assembled / non assemblato



0,54 m³ - 42 kg.
66x55x63cm.
62x57x42cm.
4 pcs (carton)

Frame Finishing & Codes / Finiture Telai e Codici

cod.191.--/IKURB white/bianca	€	706,00
cod.191.--/IKURN black/nera	€	706,00
cod.191.--/IKURL polished/lucida	€	732,00
cod.191.--/IBURB white/bianca	€	734,00
cod.191.--/IBURN black/nera	€	734,00
cod.191.--/IBURL polished/lucida	€	762,00
cod.191.--/IDKURB white/bianca	€	854,00
cod.191.--/IDKURN black/nera	€	854,00
cod.191.--/IDKURL polished/lucida	€	880,00
cod.191./ITCURB white/bianca	€	650,00
cod.191./ITCURN black/nera	€	650,00
cod.191./ITCURL polished/lucida	€	676,00

Fabric required
Fabbisogno di tessuto
1 pcs: Lin Mtrs 1,0 (h1,40)

COM fabric min. order
10pcs each code
Tessuto cliente TC ordine
min. 10pz per codice

Min. order 4pcs
each code
Ordine min 4pz
per codice

AKAMI U BR UPHOLSTERED



PU-Flex padded and upholstered shell, swivel on 4-blade aluminum painted base, armrests.
Scocca imbottita in PU-Flex e rivestita, girevole su basamento verniciato in alluminio a 4 razze, braccioli.

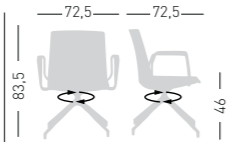

NA not assembled / non assemblato



Specify in the order the color of the armrest: white or black
Specificare nell'ordine il colore del bracciolo: bianco o nero

Frame Finishing & Codes / Finiture Telai e Codici
cod.191.--/IKUBB white/bianca € 694,00
cod.191.--/IKUNB black/nera € 694,00
cod.191.--/IKULB polished/lucida € 720,00
cod.191.--/IBUBB white/bianca € 722,00
cod.191.--/IBUNB black/nera € 722,00
cod.191.--/IBULB polished/lucida € 748,00
cod.191.--/IDKUBB white/bianca € 842,00
cod.191.--/IDKUNB black/nera € 842,00
cod.191.--/IDKULB polished/lucida € 870,00
cod.191.--/ITCUBB white/bianca € 636,00
cod.191.--/ITCUNB black/nera € 636,00
cod.191.--/ITCULB polished/lucida € 662,00

Fabric required
Fabbisogno di tessuto
1 pcs: Lin Mtrs 1,0 (h1,40)

COM fabric min. order
10pcs each code
Tessuto cliente TC ordine
min. 10pz per codice

Min. order 4pcs
each code
Ordine min 4pz
per codice

AKAMI UR BR UPHOLSTERED



PU-Flex padded and upholstered shell, swivel on 4-blade aluminum painted base, with castors and armrests.
Scocca imbottita in PU-Flex e rivestita, girevole su basamento verniciato in alluminio a 4 razze su ruote, braccioli.

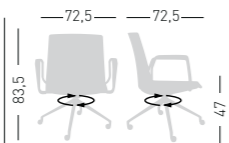

NA not assembled / non assemblato



Specify in the order the color of the armrest: white or black
Specificare nell'ordine il colore del bracciolo: bianco o nero

Frame Finishing & Codes / Finiture Telai e Codici
cod.191.--/IKURBB white/bianca € 748,00
cod.191.--/IKURNB black/nera € 748,00
cod.191.--/IKURLB polished/lucida € 774,00
cod.191.--/IBURBB white/bianca € 776,00
cod.191.--/IBURNB black/nera € 776,00
cod.191.--/IBURLB polished/lucida € 804,00
cod.191.--/IDKURBB white/bianca € 898,00
cod.191.--/IDKURNB black/nera € 898,00
cod.191.--/IDKURLB polished/lucida € 924,00
cod.191.--/ITCURBB white/bianca € 694,00
cod.191.--/ITCURNB black/nera € 694,00
cod.191.--/ITCURLB polished/lucida € 720,00

Fabric required
Fabbisogno di tessuto
1 pcs: Lin Mtrs 1,0 (h1,40)

COM fabric min. order
10pcs each code
Tessuto cliente TC ordine
min. 10pz per codice

Min. order 4pcs
each code
Ordine min 4pz
per codice

AKAMI PG UPHOLSTERED



PU-FLEX shell upholstered by King, Kvadrat or Fenice fabric.
Scocca in PU-FLEX rivestito tessuto King, Kvadrat o Fenice.

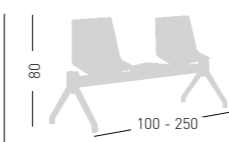

NA not assembled / non assemblato

Fabric required
Fabbisogno di tessuto
1 pcs: Lin Mtrs 1,0 (h1,40)

Frame Finishing & Codes / Finiture Telai e Codici
cod.191.--/IKPG2P-- (100 cm) € 1.128,00
cod.191.--/IKPG3P-- (150 cm) € 1.456,00
cod.191.--/IKPG4P-- (200 cm) € 1.784,00
cod.191.--/IKPG5P-- (250 cm) € 2.110,00
cod.191.--/IDKPG2P-- (100 cm) € 1.428,00
cod.191.--/IDKPG3P-- (150 cm) € 1.906,00
cod.191.--/IDKPG4P-- (200 cm) € 2.378,00
cod.191.--/IDKPG5P-- (250 cm) € 2.856,00
cod.191.--/IBPG2P-- (100 cm) € 1.486,00
cod.191.--/IBPG3P-- (150 cm) € 1.812,00
cod.191.--/IBPG4P-- (200 cm) € 2.138,00
cod.191.--/IBPG5P-- (250 cm) € 2.464,00
cod.191./ITCPG2P-- (100 cm) € 1.016,00
cod.191./ITCPG3P-- (150 cm) € 1.288,00
cod.191./ITCPG4P-- (200 cm) € 1.558,00
cod.191./ITCPG5P-- (250 cm) € 1.832,00

Bench legs available colors: 00-06-10-13-14-33-34-42
It is possible to change a seat with a grey metal top.
Colori disponibili gambe panca: 00-06-10-13-14-33-34-42
È possibile sostituire la seduta con un tavolino grigio in metallo.

Alhambra



Available colors / Colori disponibili

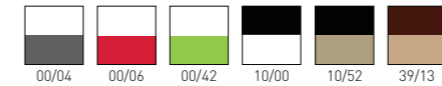

Shell / Scocca
Exagon design / Disegno esagonale

ALHAMBRA NA



Chromed, black or white painted 4-Legged metal frame, techno-polymer multicolor shell.
Struttura in metallo 4 gambe, cromata, verniciata nera o bianca, scocca in tecnopolimero multicolore.



only for painted frames
solo per telai verniciati

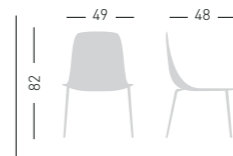

stackable / impilabile (5pcs)

NA not assembled / non assemblato



Frame Finishing & Codes / Finiture Telai e Codici

cod.92.--/NA chromed/cromata € 174,00
cod.92.--/NAB white painted/verniciato bianco € 206,00
cod.92.--/NAN black painted/verniciato nero € 206,00

ALHAMBRA TB



Chromed or painted 4-Legged metal frame with armrests, techno-polymer multicolor shell.
Struttura in metallo 4 gambe con braccioli, cromata o verniciata, scocca in tecnopolimero multicolore.



only for painted frames
solo per telai verniciati

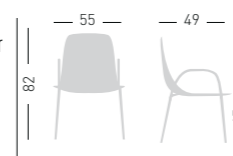

stackable / impilabile (4pcs)

NA not assembled / non assemblato



Frame Finishing & Codes / Finiture Telai e Codici

cod.92.--/TB chromed/cromata € 210,00
cod.92.--/TBB white painted/verniciato bianco € 248,00

ALHAMBRA TC



Chromed or painted wire steel metal frame, techno-polymer multicolor shell.
Struttura a traliccio in filo, cromata o verniciata, scocca in tecnopolimero multicolore.



only for painted frames
solo per telai verniciati

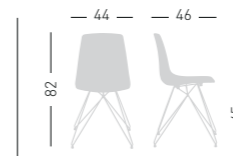

NA not assembled / non assemblato

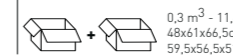

Frame Finishing & Codes / Finiture Telai e Codici

cod.92.--/TC chromed/cromata € 194,00
cod.92.--/TCB white painted/verniciato bianco € 218,00
cod.92.--/TCN black painted/verniciato nero € 218,00

ALHAMBRA TP

Techno-polymer 4-Legged frame, white painted, techno-polymer multicolor shell.
Struttura in tecnopolimero 4 gambe verniciata bianca, scocca in tecnopolimero multicolore.

CATAS
TESTATO - TESTED

BIEMA

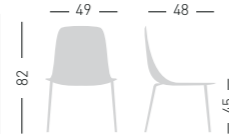

stackable / impilabile (4pcs)
NA not assembled / non assemblato



0,24 m³ - 22,60 kg.
55x65,5x63cm.
4 pcs [carton]

Frame Finishing & Codes / Finiture Telai e Codici

cod.92.--/TPB white/bianco

€ 232,00

ALHAMBRA S

Chromed, black or white painted wire steel sled frame, techno-polymer multicolor shell.
Struttura a slitta in filo, cromata o verniciata nera o bianca, scocca in tecnopolimero multicolore.



only for paintend frames
solo per telai verniciati

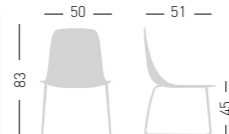

stackable / impilabile (8pcs)
NA not assembled / non assemblato



0,19 m³ - 25 kg.
62x48x66cm.
4 pcs [carton]

Frame Finishing & Codes / Finiture Telai e Codici

cod.92.--/S chromed/cromata
cod.92.--/SB white painted/verniciato bianco
cod.92.--/SN black painted/verniciato nero

€ 174,00
€ 206,00
€ 206,00

ALHAMBRA ST

Chromed or painted sled steel frame, techno-polymer multicolor shell.
Struttura a slitta, cromata o verniciata, scocca in tecnopolimero multicolore.



only for paintend frames
solo per telai verniciati



stackable / impilabile (6pcs)
NA not assembled / non assemblato



0,24 m³ - 23,6 kg.
66x55x63cm.
4 pcs [carton]

Frame Finishing & Codes / Finiture Telai e Codici

cod.92.--/ST chromed/cromata
cod.92.--/STB white painted/verniciato bianco
cod.92.--/STN black painted/verniciato nero

€ 192,00
€ 216,00
€ 216,00

ALHAMBRA 5R

Swivel on polished aluminum base with castors, height adjustable, techno-polymer multicolor shell.
Girevole su basamento in alluminio pulito con ruote, regolabile in altezza, scocca in tecnopolimero multicolore.

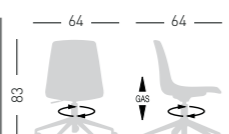

NA not assembled / non assemblato



0,24 m³ - 15 kg.
55x65,5x63 cm
2 pcs [carton]

Frame Finishing & Codes / Finiture Telai e Codici

cod.92.--/5R polished/lucida

€ 264,00

ALHAMBRA L

Swivel on 4-spur polished aluminum base, techno-polymer multicolor shell.
Girevole su basamento 4 razze in alluminio pulito, scocca in tecnopolimero multicolore.

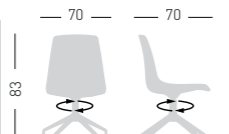

NA not assembled / non assemblato



0,24 m³ - 13 kg.
55x65,5x63 cm
2 pcs [carton]

Frame Finishing & Codes / Finiture Telai e Codici

cod.92.--/L polished/lucida

€ 364,00

Felt Glides / Tappi in feltro

ALHAMBRA ECO

"Compound wood" and techno-polymer 4-Legged frame and shell.
Scocca e struttura a 4 gambe in composito di legno e materiale plastico.

CATAS
TESTATO - TESTED

BIEMA



ECO/13

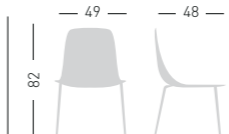

stackable / impilabile (4pcs)
NA not assembled / non assemblato



0,24 m³ - 22 kg.
55x65,5x63cm.
4 pcs [carton]

Frame Finishing & Codes / Finiture Telai e Codici

cod.92.ECO-13/TPE

€ 292,00

ALHAMBRA CONNECTING SYSTEM GANCIO CONNESSIONE

Set linking glides for in-line disposal.
Set piedini con agganci per disporre le sedute in linea.

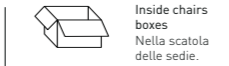

Inside chairs boxes
Nella scatola delle sedie.

Assembled / assemblato

Frame Finishing & Codes / Finiture Telai e Codici

cod.1012

€ 20,00

available for models: S
disponibile per versioni: S

ALHAMBRA CHAIRS TROLLEY CARRELLO PER SEDIE

Trolley for chairs, chromed metal structure.
Carrello porta sedie, struttura in metallo cromato.



0,3 m³ - 10kg
63x75x58cm.
1 pcs [carton]

Frame Finishing & Codes / Finiture Telai e Codici

cod.2000/A

€ 242,00

available for models: S
disponibile per versioni: S

stackable on trolley 18 pcs
impilabili su carrello 18 pcs

max height with 18 chairs 178 cm
altezza carrello con 18 sedie 178 cm

ALHAMBRA CHAIRS TROLLEY CARRELLO PER SEDIE

Painted grey adjustable Dolly, for 4 legged chairs.
Carrello per sedie 4 gambe, regolabile, verniciato grigio.

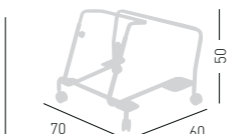

0,3 m³ - 8kg
62x72x51cm.
1 pcs [carton]

Frame Finishing & Codes / Finiture Telai e Codici

cod.2001/A

€ 290,00

available for models: NA
disponibile per versioni: NA

ALHAMBRA UPHOLSTERED IMBOTTITE

Available fabric / Tessuti disponibili
Aurea eco-leather / Ecopelle aurea **E** (4pcs min.)
King fabric / Tessuto King **K** (4pcs min.)
Blazer fabric / Tessuto Blazer **B** (4pcs min.)
COM fabric / Tessuto cliente **TC** (10pcs min.)

DRESS ALHAMBRA BL



Techno-polymer padded and upholstered shell. Beech wooden frame
Scocca in tecnopolimero, imbottita e rivestita. Telaio in legno.

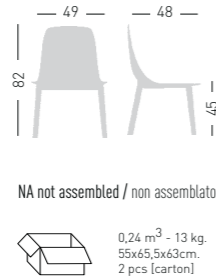

NA not assembled / non assemblato



Frame Finishing & Codes / Finiture Telai e Codici

cod.92.--/IEBLF beech/faggio	€ 726,00
cod.92.--/IKBLF beech/faggio	€ 726,00
cod.92.--/IBBLF beech/faggio	€ 754,00
cod.92.--/ITCBLF beech/faggio	€ 680,00

Fabric required
Fabbisogno di tessuto
1 pcs: Lin Mtrs 1,0 (h1,40)

COM fabric min. order
10pcs each code
Tessuto cliente TC ordine
min. 10pz per codice

Min. order 4pcs
each code
Ordine min 4pz
per codice

DRESS ALHAMBRA NA



Techno-polymer padded and upholstered shell. Chromed, black or white painted metal frame.
Scocca in tecnopolimero, imbottita e rivestita. Telaio in metallo cromato, verniciato nero o bianco.

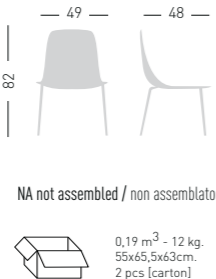

NA not assembled / non assemblato



Frame Finishing & Codes / Finiture Telai e Codici

cod.92.--/IENA chromed/cromata	€ 396,00
cod.92.--/IKNA chromed/cromata	€ 396,00
cod.92.--/IBNA chromed/cromata	€ 426,00
cod.92./ITCNA chromed/cromata	€ 342,00
cod.92.--/IENAB white painted/verniciato bianco	€ 434,00
cod.92.--/IKNAB white painted/verniciato bianco	€ 434,00
cod.92.--/IBNAB white painted/verniciato bianco	€ 462,00
cod.92./ITCNAB white painted/verniciato bianco	€ 378,00
cod.92.--/IENAN black painted/verniciato nero	€ 434,00
cod.92.--/IKNAN black painted/verniciato nero	€ 434,00
cod.92.--/IBNAN black painted/verniciato nero	€ 462,00
cod.92./ITCNAN black painted/verniciato nero	€ 378,00

Fabric required
Fabbisogno di tessuto
1 pcs: Lin Mtrs 1,0 (h1,40)

COM fabric min. order
10pcs each code
Tessuto cliente TC ordine
min. 10pz per codice

Min. order 4pcs
each code
Ordine min 4pz
per codice

DRESS ALHAMBRA TB



Techno-polymer padded and upholstered shell. Chromed or painted metal frame with arms.
Scocca in tecnopolimero, imbottita e rivestita. Telaio in metallo cromato o verniciato con braccioli.



NA not assembled / non assemblato



Frame Finishing & Codes / Finiture Telai e Codici

cod.92.--/IETB chromed/cromata	€ 426,00
cod.92.--/IKTB chromed/cromata	€ 426,00
cod.92.--/IBTB chromed/cromata	€ 456,00
cod.92./ITCTB chromed/cromata	€ 370,00
cod.92.--/IETBB white painted/verniciato bianco	€ 488,00
cod.92.--/IKTBB white painted/verniciato bianco	€ 488,00
cod.92.--/IBTBB white painted/verniciato bianco	€ 518,00
cod.92./ITCTBB white painted/verniciato bianco	€ 434,00

Fabric required
Fabbisogno di tessuto
1 pcs: Lin Mtrs 1,0 (h1,40)

COM fabric min. order
10pcs each code
Tessuto cliente TC ordine
min. 10pz per codice

Min. order 4pcs
each code
Ordine min 4pz
per codice

DRESS ALHAMBRA TC



Techno-polymer padded and upholstered shell. Chromed or painted metal frame.
Scocca in tecnopolimero, imbottita e rivestita. Telaio in metallo cromato o verniciato.

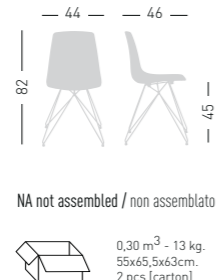

NA not assembled / non assemblato



Frame Finishing & Codes / Finiture Telai e Codici

cod.92.--/IETC chromed/cromata	€ 436,00
cod.92.--/IKTC chromed/cromata	€ 436,00
cod.92.--/IBTC chromed/cromata	€ 464,00
cod.92./ITCTC chromed/cromata	€ 380,00
cod.92.--/IETCB white painted/verniciato bianco	€ 466,00
cod.92.--/IKTCB white painted/verniciato bianco	€ 466,00
cod.92.--/IBTCB white painted/verniciato bianco	€ 496,00
cod.92./ITCTCB white painted/verniciato bianco	€ 410,00
cod.92.--/IETCN black painted/verniciato nero	€ 466,00
cod.92.--/IKTCN black painted/verniciato nero	€ 466,00
cod.92.--/IBTCN black painted/verniciato nero	€ 496,00
cod.92./ITCTCN black painted/verniciato nero	€ 410,00

Fabric required
Fabbisogno di tessuto
1 pcs: Lin Mtrs 1,0 (h1,40)

COM fabric min. order
10pcs each code
Tessuto cliente TC ordine
min. 10pz per codice

Min. order 4pcs
each code
Ordine min 4pz
per codice

DRESS ALHAMBRA TP



Techno-polymer padded and upholstered shell. Techno-polymer padded frame.
Scocca in tecnopolimero, imbottita e rivestita. Telaio in tecnopolimero verniciato.

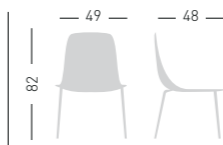

NA not assembled / non assemblato



Frame Finishing & Codes / Finiture Telai e Codici

cod.92.--/IETPB white painted/verniciato bianco	€ 458,00
cod.92.--/IKTPB white painted/verniciato bianco	€ 458,00
cod.92.--/IBTPB white painted/verniciato bianco	€ 486,00
cod.92./ITCTPB white painted/verniciato bianco	€ 402,00

Fabric required
Fabbisogno di tessuto
1 pcs: Lin Mtrs 1,0 (h1,40)

COM fabric min. order
10pcs each code
Tessuto cliente TC ordine
min. 10pz per codice

Min. order 4pcs
each code
Ordine min 4pz
per codice

DRESS ALHAMBRA S



Techno-polymer padded and upholstered shell. Chromed, painted black or white wire steel metal frame.
Scocca in tecnopolimero, imbottita e rivestita. Telaio slitta in filo cromato, verniciato nero o bianco.



NA not assembled / non assemblato



Frame Finishing & Codes / Finiture Telai e Codici

cod.92.--/IES chromed/cromata	€ 396,00
cod.92.--/IKS chromed/cromata	€ 396,00
cod.92.--/IBS chromed/cromata	€ 426,00
cod.92./ITCS chromed/cromata	€ 342,00
cod.92.--/IESB white painted/verniciato bianco	€ 434,00
cod.92.--/IKSB white painted/verniciato bianco	€ 434,00
cod.92.--/IBSB white painted/verniciato bianco	€ 462,00
cod.92./ITCSB white painted/verniciato bianco	€ 378,00
cod.92.--/IESN black painted/verniciato nero	€ 434,00
cod.92.--/IKSN black painted/verniciato nero	€ 434,00
cod.92.--/IBSN black painted/verniciato nero	€ 462,00
cod.92./ITCSN black painted/verniciato nero	€ 378,00

Fabric required
Fabbisogno di tessuto
1 pcs: Lin Mtrs 1,0 (h1,40)

COM fabric min. order
10pcs each code
Tessuto cliente TC ordine
min. 10pz per codice

Min. order 4pcs
each code
Ordine min 4pz
per codice

DRESS ALHAMBRA ST



Techno-polymer padded and upholstered shell. Chromed or painted sled metal frame.
Scocca in tecnopolimero, imbottita e rivestita. Telaio slitta in metallo cromato o verniciato.



NA not assembled / non assemblato



Frame Finishing & Codes / Finiture Telai e Codici

cod.92.--/IEST chromed/cromata	€ 434,00
cod.92.--/IKST chromed/cromata	€ 434,00
cod.92.--/IBST chromed/cromata	€ 462,00
cod.92./ITCST chromed/cromata	€ 378,00
cod.92.--/IESTB white painted/verniciato bianco	€ 474,00
cod.92.--/IKSTB white painted/verniciato bianco	€ 474,00
cod.92.--/IBSTB white painted/verniciato bianco	€ 502,00
cod.92./ITCSTB white painted/verniciato bianco	€ 416,00
cod.92.--/IESTN black painted/verniciato nero	€ 474,00
cod.92.--/IKSTN black painted/verniciato nero	€ 474,00
cod.92.--/IBSTN black painted/verniciato nero	€ 502,00
cod.92./ITCSTN black painted/verniciato nero	€ 416,00

Fabric required
Fabbisogno di tessuto
1 pcs: Lin Mtrs 1,0 (h1,40)

COM fabric min. order
10pcs each code
Tessuto cliente TC ordine
min. 10pz per codice

Min. order 4pcs
each code
Ordine min 4pz
per codice

DRESS ALHAMBRA 5R



Techno-polymer padded and upholstered shell. Polished aluminum base with castors.
Scocca in tecnopolimero, imbottita e rivestita. Base in alluminio pulito con ruote.

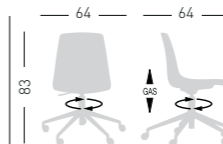

NA not assembled / non assemblato



Frame Finishing & Codes / Finiture Telai e Codici

cod.92.--/IE5R polished/lucida	€ 608,00
cod.92.--/IK5R polished/lucida	€ 608,00
cod.92.--/IB5R polished/lucida	€ 636,00
cod.92./ITC5R polished/lucida	€ 552,00

Fabric required
Fabbisogno di tessuto
1 pcs: Lin Mtrs 1,0 (h1,40)

COM fabric min. order
10pcs each code
Tessuto cliente TC ordine
min. 10pz per codice

Min. order 4pcs
each code
Ordine min 4pz
per codice

DRESS ALHAMBRA LIE



Techno-polymer padded and upholstered shell. Polished aluminum base.
Scocca in tecnopolimero, imbottita e rivestita. Base in alluminio pulito.

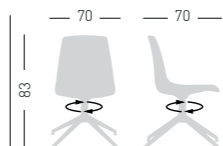

NA not assembled / non assemblato



Frame Finishing & Codes / Finiture Telai e Codici

cod.92.--/IEL polished/lucida	€ 608,00
cod.92.--/IKL polished/lucida	€ 608,00
cod.92.--/IBL polished/lucida	€ 636,00
cod.92./ITCL polished/lucida	€ 552,00

Felt Glides / Tappi in feltro

Fabric required
Fabbisogno di tessuto
1 pcs: Lin Mtrs 1,0 (h1,40)

COM fabric min. order
10pcs each code
Tessuto cliente TC ordine
min. 10pz per codice

Min. order 4pcs
each code
Ordine min 4pz
per codice

Amitha



Available colors / Colori disponibili



AMITHA



4-Legged metal chair, painted with special treatment for outdoor purpose.
Sedia con struttura 4 gambe in metallo verniciato con trattamento per esterno.



Frame Finishing & Codes / Finiture Telai e Codici

cod. 77._/A

€ 268,00

Min. order 4pcs
each code
Ordine min 4pz
per codice

AMITHA B



4-Legged metal chair with armrests, painted with special treatment for outdoor purpose.
Sedia con struttura 4 gambe con braccioli in metallo verniciato con trattamento per esterno.

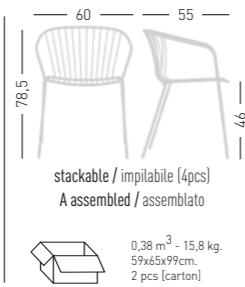

Frame Finishing & Codes / Finiture Telai e Codici

cod. 78._/A

€ 322,00

Min. order 4pcs
each code
Ordine min 4pz
per codice

AMITHA SLIM CUSHION / CUSCINO



Cushion for Amitha chairs and armchairs, with removable cover, suitable for outdoor purpose; high density bi-elastic rubber padding, stitching made with raised edge. The cushion is fixed to the chair by Velcro straps.

Cuscino sfoderabile per sedie e sedie con braccioli Amitha, adatto ad uso per esterni; imbottiture in gomma bielastica ad alta densità, cucitura realizzata con bordino in rilievo riportato. Il cuscino si fissa alla sedia per mezzo di fascette in Velcro.



0,6 kg.
Inside chairs boxes
Inseriti nella
scatola delle sedie

Frame Finishing & Codes / Finiture Telai e Codici

cod. 338.-- (MG)
cod. 338.-- (SX)

Available fabric.
Tessuti disponibili.
MG, SX

€ 150,00
€ 150,00

Min. order 4pcs
each code
Ordine min 4pz
per codice

AMITHA FAT CUSHION / CUSCINO



Cushion for Amitha chairs and armchairs, suitable for outdoor purpose; wash up to 30°. The cushion is fixed to the chair by clip buttons.
Cuscino per sedie e poltroncine Amitha, adatto ad uso per esterni; lavabile a 30°. Il cuscino si fissa alla sedia per mezzo di bottoni a clip.



0,3 kg.
Inside chairs boxes
Inseriti nella
scatola delle sedie

Frame Finishing & Codes / Finiture Telai e Codici

cod.435.-- (GR)

Available fabric.
Tessuti disponibili.
GR

€ 150,00

Min. order 4pcs
each code
Ordine min 4pz
per codice

AMITHA FAT SEAT & BACK CUSHION / CUSCINO SEDILO SCHIENALE



Seat-back cushion for Amitha chairs and armchairs, suitable for outdoor purpose; wash up to 30°. The cushion is fixed to the chair by clip buttons.
Cuscino sedile-schienale per sedie e poltroncine Amitha, adatto ad uso per esterni; lavabile a 30°. Il cuscino si fissa alla sedia per mezzo di bottoni a clip.



0,7 kg.
Inside chairs boxes
Inseriti nella
scatola delle sedie

Frame Finishing & Codes / Finiture Telai e Codici

cod.434.-- (GR)

Available fabric.
Tessuti disponibili.
GR

€ 330,00

Min. order 4pcs
each code
Ordine min 4pz
per codice



IGN Versions follows UNI 9177 certification in terms of Fire Resistance, Fire Reaction Class 1
Versioni IGN prodotto Omologato con Classe di Reazione al fuoco 1, UNI 9177



Available Shell Color / Colori disponibili Scocca

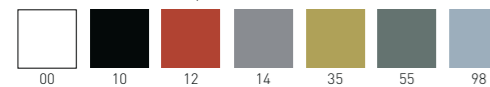

Frame Finishes / Finiture telaio

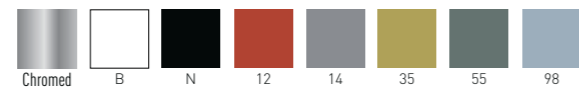

ARTESIA S

Chromed or Painted wire steel sled frame, techno-polymer shell.
Struttura a slitta in filo, cromata o verniciata, scocca in tecnopolimero.

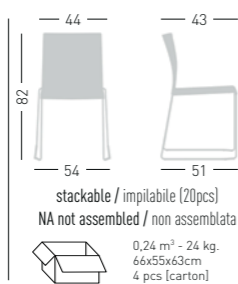

Frame Finishing & Codes / Finiture Telaie e Codici

cod. 110.--/S chromed/cromata	€ 154,00
cod. 110.--/SB white painted/verniciato bianco	€ 154,00
cod. 110.--/SN black painted/verniciato nero	€ 154,00
cod. 110.--/S55 mineral grey painted/verniciato grigio minerale	€ 178,00
cod. 110.--/S14 pearl grey painted/verniciato grigio perla	€ 178,00
cod. 110.--/S12 brick painted/verniciato mattone	€ 178,00
cod. 110.--/S35 lime painted/verniciato lime	€ 178,00
cod. 110.--/S98 pale blue painted/verniciato avio	€ 178,00
cod. 110.00/IGNS-- Fire Retardant/Ignifuga Classe 1	€ 206,00
cod. 110.55/IGNS-- Fire Retardant/Ignifuga Classe 1	€ 206,00
cod. 110.14/IGNS-- Fire Retardant/Ignifuga Classe 1	€ 206,00
cod. 110.98/IGNS-- Fire Retardant/Ignifuga Classe 1	€ 206,00

Fire Retardant minimum Order 20pcs
Ignifuga ordine Minimo 20pz

Black glides on black frames.
Neutral glides on other frame finishes.
Piedini neri su telai neri.
Piedini neutri nelle altre finiture telaio.

ARTESIA SS

Chromed or Painted wire steel sled frame with armrests, techno-polymer shell.
Struttura a slitta in filo con braccioli, cromata o verniciata, scocca in tecnopolimero.



The arm pads are in the same color of the shell.
Il copibracciolo è dello stesso colore della scocca.

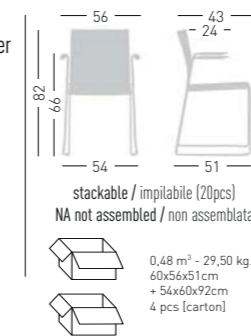

Frame Finishing & Codes / Finiture Telaie e Codici

cod. 110.--/SS chromed/cromata	€ 198,00
cod. 110.--/SSN black painted/verniciato nero	€ 198,00
cod. 110.00-00/IGNSS chromed/cromata Fire Retardant/Ignifuga Classe 1	€ 248,00
cod. 110.00-00/IGNSSN black painted/verniciato nero Fire Retardant/Ignifuga Classe 1	€ 248,00
cod. 110.55-55/IGNSS chromed/cromata Fire Retardant/Ignifuga Classe 1	€ 248,00
cod. 110.55-55/IGNSSN black painted/verniciato nero Fire Retardant/Ignifuga Classe 1	€ 248,00
cod. 110.14-14/IGNSS chromed/cromata Fire Retardant/Ignifuga Classe 1	€ 248,00
cod. 110.14-14/IGNSSN black painted/verniciato nero Fire Retardant/Ignifuga Classe 1	€ 248,00
cod. 110.98-98/IGNSS chromed/cromata Fire Retardant/Ignifuga Classe 1	€ 248,00
cod. 110.98-98/IGNSSN black painted/verniciato nero Fire Retardant/Ignifuga Classe 1	€ 248,00

Fire Retardant minimum Order 20pcs
Ignifuga ordine Minimo 20pz

Black glides on black frames.
Neutral glides on other frame finishes.
Piedini neri su telai neri.
Piedini neutri nelle altre finiture telaio.

ARTESIA TABLET / TAVOLETTA

Removable anti-panic tablet, chromed wire steel frame, die cast aluminum polished joint, techno-polymer arm and tablet.
Tavoletta antipanico removibile, telaio in filo di acciaio cromato, snodo in alluminio pulito, bracciolo e tavoletta in tecnopolimero.

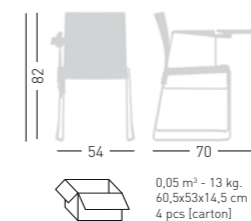

Frame Finishing & Codes / Finiture Telaie e Codici

cod. 1210.--G1 chromed frame/struttura cromata	€ 140,00
--	----------

Min. order 4pcs
each code
Ordine min 4pz
per codice

Arm & Fittings colours / Colore bracciolo e fissaggi

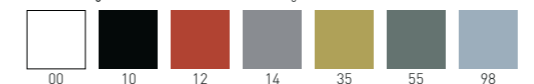

Tablet Color / Colore Tavoletta



ARTESIA NARROW CUSHION / CUSCINO STRETTO

Narrow upholstered cushion, suitable for chair stackability.
Cuscino tappezzato stretto, adatto a sedute che devono essere impilate.

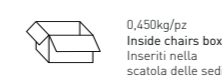

Frame Finishing & Codes / Finiture Telaie e Codici

cod.330.-- (B)	€ 124,00
cod.330.-- (E)	€ 106,00
cod.330.-- (K)	€ 106,00
cod.330.-- (DK)	€ 130,00
cod.330.TC COM fabric/tessuto cliente	€ 92,00

Fabric required
Fabbisogno di tessuto
4 pcs: Lin Mtrs 1,0 (h1,40)

COM fabric min. order
10pcs each code
Tessuto cliente TC ordine
min. 10pz per codice

Min. order 4pcs
each code
Ordine min 4pz
per codice

ARTESIA WIDE CUSHION / CUSCINO LARGO

Large upholstered cushion.
Cuscino tappezzato largo.



Frame Finishing & Codes / Finiture Telaie e Codici

cod.331.-- (B)	€ 130,00
cod.331.-- (E)	€ 112,00
cod.331.-- (K)	€ 112,00
cod.331.-- (DK)	€ 136,00
cod.331.TC COM fabric/tessuto cliente	€ 98,00

Fabric required
Fabbisogno di tessuto
4 pcs: Lin Mtrs 1,2 (h1,40)

COM fabric min. order
10pcs each code
Tessuto cliente TC ordine
min. 10pz per codice

Min. order 4pcs
each code
Ordine min 4pz
per codice

ARTESIA
FELT GLIDES
PIEDINI IN FELTRO



Felt glides for delicate surfaces.
Piedini in Feltro per superfici delicate.

NA not assembled / non assemblata



Inside chairs boxes
Inseriti nella confezione

Frame Finishing & Codes / Finiture Telai e Codici

cod.ACCS001.F

€ 6,00

ARTESIA
LINKING / AGGANCI



Set linking glides for in-line disposal.
Set piedini con agganci per disporre le sedute in linea.

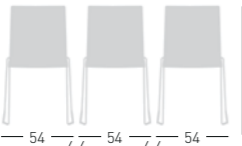

Frame Finishing & Codes / Finiture Telai e Codici

cod.1013 neutral/neutro
cod.1013.10 black/nero

€ 20,00
€ 20,00

Available for model S (even with tablet) and SS
Disponibile per versioni S (anche con tavoletta) e SS.



Inside chairs boxes
Inseriti nella scatola delle sedie

ARTESIA
CHAIR TROLLEY /
CARRELLO PER SEDIE



Trolley for Chairs with handle, painted black metal structure, heavy duty castors with brakes.

Carrello porta sedie con maniglia, struttura in metallo verniciata nera, ruote ad alta resistenza con freni.

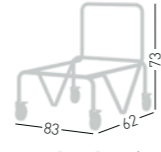

Frame Finishing & Codes / Finiture Telai e Codici

cod.2008/A

€ 474,00

Available for model S and SS
Disponibile per versioni S e SS

Stackable on trolley 50pcs (H210cm)
Impilabili su carrello 50pz (H210cm)



0,42 m³ - 11,50 kg.
74x58x97cm
1 pcs [carton]

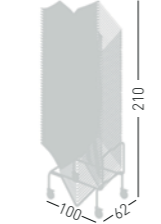

ARTESIA
TABLET TROLLEY /
CARRELLO PER TAVOLETTE



Trolley for tablets, chromed metal structure, castors with brakes.
Carrello porta-tavolette, struttura in metallo cromato, ruote con freno.

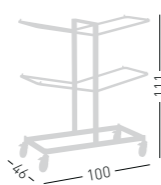

Frame Finishing & Codes / Finiture Telai e Codici

cod.2009/A

€ 848,00

Stackable on trolley 24 tablets
Accatatabili su carrello 24 tavolette



0,41 m³ - 14,5 kg.
74x57,5x96,5cm
1 pc [carton]



Available colors / Colori disponibili

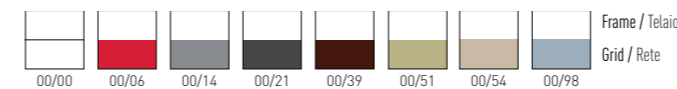
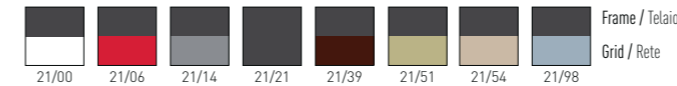

AVENICA



Techno-polymer twin-material chair with integrated armrests.
Sedia in tecnopolimero bi-materiale con braccioli integrati.

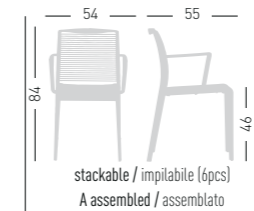

stackable / impilabile (6pcs)
A assembled / assemblato



0,46 m³ - 22 kg.
58x75x102cm.
4 pcs [carton]

Frame Finishing & Codes / Finiture Telai e Codici

cod.375._._/A

€ 214,00



Bakhita

Available colors / Colori disponibili

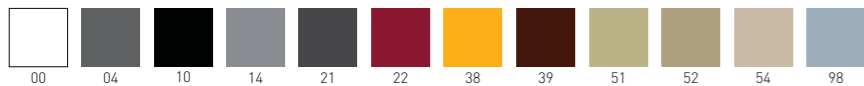

IGN Versions follows UNI 9177 certification in terms of Fire Resistance, Fire Reaction Class 1
Versioni IGN prodotto Omologato con Classe di Reazione al fuoco 1, UNI 9177



BAKHITA

Twin-material techno-polymer chair.
Sedia bi-materiale in tecnopolimero.

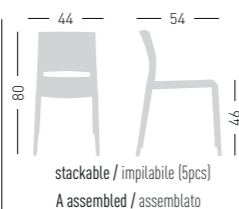

stackable / impilabile (5pcs)
A assembled / assemblato



Frame Finishing & Codes / Finiture Telai e Codici

cod.370.--/A

€ **148,00**

cod.370.00/IGN white fire retardant/bianco ignifuga

Minimum order 20pcs/ Ordine minimo 20pz

cod.370.--/IGN fire retardant/ignifuga

Minimum order 300pcs/ Ordine minimo 300pz

€ **198,00**

€ **198,00**

BAKHITA B

Twin-material techno-polymer chair with integrated armrests.
Sedia bi-materiale in tecnopolimero con braccioli integrati.

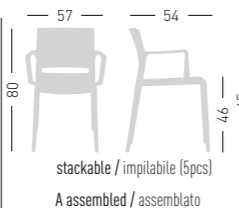

stackable / impilabile (5pcs)
A assembled / assemblato



Frame Finishing & Codes / Finiture Telai e Codici

cod.371.--/A

€ **168,00**

cod.371.--/IGN fire retardant/ignifuga

Minimum order 300pcs/ Ordine minimo 300pz

€ **224,00**

BAKHITA CUSHION / CUSCINO

Bakhita cushion, complete with white under seat cover.
Cuscino Bakhita, completo di sottoscocca bianco.



Available fabric.
Tessuti disponibili.
B, E, K, DK, TC



0,5 kg.
Inside chairs boxes
Nella scatola delle sedie.

Frame Finishing & Codes / Finiture Telai e Codici

cod.311.-- (B)

€ **134,00**

cod.311.-- (E)

€ **118,00**

cod.311.-- (K)

€ **118,00**

cod.311.-- (DK)

€ **144,00**

cod.311.TC COM fabric/tessuto cliente

€ **106,00**

Minimum order 4pcs each code
Ordine minimo 4 pezzi per codice

COM fabric minimum order 10pcs each code
Tessuto cliente TC ordine minimo 10pz per codice

Fabric required / Fabbisogno di tessuto
4 pcs : Lin Mtrs 1 (h1,40)

BAKHITA CHAIRS TROLLEY CARRELLO PER SEDIE

Trolley for 10 chairs model Bakhita, black painted.
Carrello porta 10 sedie modello Bakhita, verniciato nero.

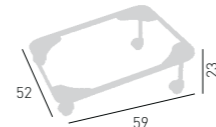

Frame Finishing & Codes / Finiture Telai e Codici

cod.2002/A

€ **222,00**



0,09 m³ - 5,5kg
41x54x25cm.
1 pcs (carton)

BAKHITA UNDERSEAT COVER COPERTINA SOTTOSEDE

Bakhita underseat cover, white.
Sottoscocca Bakhita, colore bianco.



Inside chairs boxes
Nella scatola delle sedie.

Frame Finishing & Codes / Finiture Telai e Codici

cod.334.00

€ **16,00**

BAKHITA CONNECTING SYSTEM GANCIO CONNESSIONE

Extensible chromed linking devices for in line disposal, complete with underseat cover.
Agganci estensibili cromati per disporre le sedute in linea, con sottoscocca integrato.

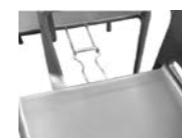

Inside chairs boxes
Nella scatola delle sedie.

Assembled / assemblato

Frame Finishing & Codes / Finiture Telai e Codici

cod.1006

€ **64,00**

Minimum order 20pcs
Ordine minimo 20 pezzi

available for models: Bakhita and Bakhita B
disponibile per versioni: Bakhita and Bakhita B

Basket



Available colors / Colori disponibili

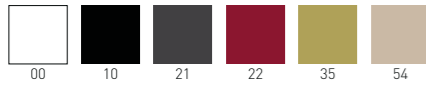

BASKET CHAIR NA



Chromed or painted 4-Legged metal frame, techno-polymer shell. Struttura in metallo 4 gambe, cromata o verniciata, scocca in tecnopolimero.



Available Painted Frame Colors / Colori disponibili Telaio Verniciato

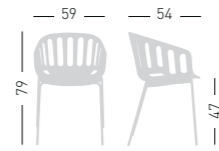
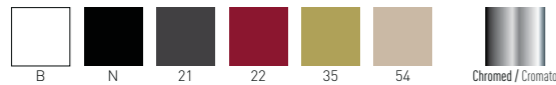

stackable / impilabile (4pcs)
NA not assembled / non assemblato
0,27 m³ - 21,60 kg.
64x64x64cm.
4 pcs [carton]

Frame Finishing & Codes / Finiture Telai e Codici

cod.268.--/NA chromed/cromata € 180,00
cod.268.--/NAN black painted/verniciato nero € 216,00
cod.268.--/NAB white painted/verniciato bianco € 216,00
cod.268.--/NA21 painted/verniciato € 216,00
cod.268.--/NA22 painted/verniciato € 216,00
cod.268.--/NA35 painted/verniciato € 216,00
cod.268.--/NA54 painted/verniciato € 216,00

BASKET CHAIR BP



4 polymer-steel co-injected legs structure, techno-polymer shell. Struttura 4 gambe in co-iniezione metallo-polimero, scocca in tecnopolimero.



Available Legs Color / Colori disponibili Gambe

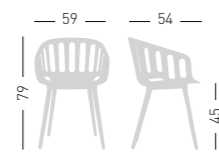
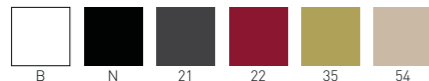

NA not assembled / non assemblato
0,24 m³ - 23,60 kg.
55x65,5x63cm.
4 pcs [carton]

Frame Finishing & Codes / Finiture Telai e Codici

cod.268.--/BP--

Legs and shells colors can be combined
I colori delle gambe possono essere abbinati alla scocca

BASKET CHAIR CTL



Chromed or black painted cantilevered metal frame, techno-polymer shell. Struttura in metallo cantilever, cromata o verniciata nera, scocca in tecnopolimero.

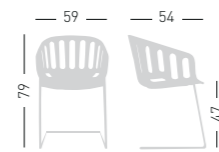
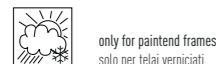

NA not assembled / non assemblato
0,18+0,24 m³ - 22,40 kg.
60x56x51cm.
66x55x63cm.
4 pcs [carton]

Frame Finishing & Codes / Finiture Telai e Codici

cod.268.--/CTL chromed/cromata € 208,00
cod.268.--/CTLN black painted/verniciato nero € 234,00

BASKET CHAIR ST



Chromed or black painted sled steel frame, techno-polymer shell. Struttura a slitta, cromata o verniciata nera, scocca in tecnopolimero.

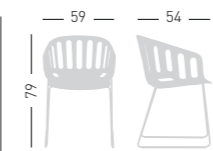

NA not assembled / non assemblato
0,18+0,24 m³ - 22,40 kg.
60x56x51cm.
66x55x63cm.
4 pcs [carton]

Frame Finishing & Codes / Finiture Telai e Codici

cod.268.--/ST chromed/cromata € 202,00
cod.268.--/STN black painted/verniciato nero € 226,00

BASKET CHAIR BL



4-Legged wooden beech frame, techno-polymer shell. Struttura in legno di faggio 4 gambe, scocca in tecnopolimero.

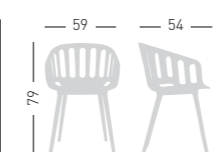

NA not assembled / non assemblato
0,36 m³ - 26,40 kg.
60x56x51cm.
60x56x51cm.
4 pcs [carton]

Frame Finishing & Codes / Finiture Telai e Codici

cod.268.--/BL_

Felt Glides / Tappi in feltro

€ 352,00

BASKET CHAIR U



Swivel on 4-blade aluminum painted base, with glides. Girevole su basamento verniciato in alluminio a 4 razze su piedini.

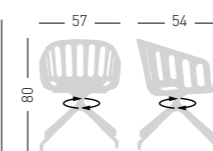

NA not assembled / non assemblato
0,15+0,18 m³ - 11 kg.
62x57x42cm
60x56x51cm
2 pcs [carton]

Frame Finishing & Codes / Finiture Telai e Codici

cod.268.--/UB white painted/verniciato bianco € 374,00
cod.268.--/UN black painted/verniciato nero € 374,00

Felt Glides / Tappi in feltro

BASKET CHAIR UR



Swivel on 4-blade aluminum painted base, with castors. Girevole su basamento verniciato in alluminio a 4 razze su ruote.

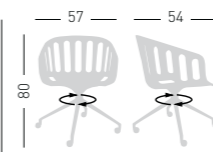

NA not assembled / non assemblato
0,15+0,18 m³ - 11,20 kg.
62x57x42cm
60x56x51cm
2 pcs [carton]

Frame Finishing & Codes / Finiture Telai e Codici

cod.268.--/URB white painted/verniciato bianco € 402,00
cod.268.--/URN black painted/verniciato nero € 402,00

BASKET PL



4-legged wooden swivel base with solid Oak spokes reinforced with inner steel structure, techno-polymer shell. Base girevole con quattro razze in rovere massello, rinforzate con struttura in acciaio interna, scocca in tecnopolimero.

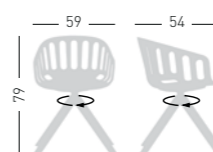
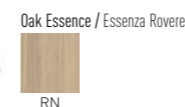

A assembled / assemblato
0,30 m³ - 8,5 kg.
54x60x92cm.
1 pc [carton]

Frame Finishing & Codes / Finiture Telai e Codici

cod.268._/PLRN Oak/Rovere

€ 520,00

BASKET CHAIR CUSHION / CUSCINO



Removable upholstered cushion.
Cuscino tappezzato removibile.

Available fabric.
Tessuti disponibili.
E, K, DK
COM fabric / Tessuto cliente **TC**



0,7 kg.
Inside chairs boxes
Nella scatola delle sedie

Frame Finishing & Codes / Finiture Telaie e Codici

cod.309.--(E)
cod.309.--(K)
cod.309.--(DK)
cod.309.TC COM fabric/tessuto cliente

€ **394,00**
€ **394,00**
€ **484,00**
€ **592,00**

Fabric required
Fabbisogno di tessuto
1 pcs: Lin Mtrs 1,8 (h1,40)

COM fabric min. order
10pcs each code
Tessuto cliente TC ordine
min. 10pz per codice

Min. order 4pcs
each code
Ordine min 4pz
per codice

BASKET CHAIR SMOOTH CUSHION / CUSCINO



Removable upholstered cushion
"Smooth" version.
Cuscino tappezzato removibile, versione "Smooth".

Available fabric.
Tessuti disponibili.
E, K, DK
COM fabric / Tessuto cliente **TC**



1 kg.
Inside chair boxes.
Nella scatola delle sedie.

Frame Finishing & Codes / Finiture Telaie e Codici

cod.329.--(E)
cod.329.--(K)
cod.329.--(DK)
cod.329.TC COM fabric/tessuto cliente

€ **394,00**
€ **394,00**
€ **484,00**
€ **296,00**

Fabric required
Fabbisogno di tessuto
1 pc: Lin Mtrs 1,8 (h1,40)

COM fabric min. order
10pcs each code
Tessuto cliente TC ordine
min. 10pz per codice

Min. order 4pcs
each code
Ordine min 4pz
per codice

BASKET UPHOLSTERED IMBOTTITE

Products follows UNI 9175 -UNI 9175/FA, in terms of Fire Resistance, Fire Reation Class 11M
Prodotto Omologato dal Ministero dell'Interno, secondo la UNI 9175 -UNI 9175/FA, con classe di Reazione al fuoco 11M



Available coverings / Finiture disponibili
King fabric / Tessuto King **K** (4pcs min.)
Blazer fabric / Tessuto Blazer **B** (4pcs min.)
Superb Trevira Velvet / Velluto Superb Trevira **S** (4pcs min.)
Kvadrat fabrics / Tessuti Kvadrat **DK** (4pcs min.)
Aurea eco-leather / Ecopelle aurea **E** (4pcs min.)
COM fabric / Tessuto cliente **TC** (10pcs min.)
Twin color upholstery details available on request /
Dettagli tappezzeria bi-colore disponibili su richiesta

BASKET CHAIR NA UPHOLSTERED



Upholstered PU-FLEX shell,
chromed or painted metal frame.
Scocca in PU-FLEX rivestita,
telaio in metallo cromato o verniciato.

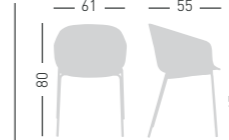

NA not assembled / non assemblato



0,24 m³ - 9,2 kg.
66x55x63cm.
1 pcs (carton)

Available Painted Frame Colors / Colori disponibili Telaio Verniciato

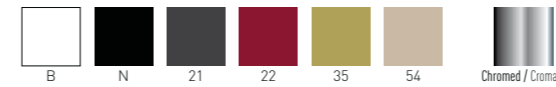

Frame Finishing & Codes / Finiture Telaie e Codici

cod.268.--/IBNA chromed/cromata	€ 696,00
cod.268.--/IBNAN black painted/verniciato nero	€ 736,00
cod.268.--/IBNAB white painted/verniciato bianco	€ 736,00
cod.268.--/IBNA21 painted/verniciata	€ 736,00
cod.268.--/IBNA22 painted/verniciata	€ 736,00
cod.268.--/IBNA35 painted/verniciata	€ 736,00
cod.268.--/IBNA54 painted/verniciata	€ 736,00
cod.268.--/IKNA chromed/cromata	€ 580,00
cod.268.--/IKNAN black painted/verniciato nero	€ 618,00
cod.268.--/IKNAB white painted/verniciato bianco	€ 618,00
cod.268.--/IKNA21 painted/verniciata	€ 618,00
cod.268.--/IKNA22 painted/verniciata	€ 618,00
cod.268.--/IKNA35 painted/verniciata	€ 618,00
cod.268.--/IKNA54 painted/verniciata	€ 618,00
cod.268.--/ISNA chromed/cromata	€ 696,00
cod.268.--/ISNAN black painted/verniciato nero	€ 736,00
cod.268.--/ISNAB white painted/verniciato bianco	€ 736,00
cod.268.--/ISNA21 painted/verniciata	€ 736,00
cod.268.--/ISNA22 painted/verniciata	€ 736,00
cod.268.--/ISNA35 painted/verniciata	€ 736,00
cod.268.--/ISNA54 painted/verniciata	€ 736,00
cod.268.--/IDKNA chromed/cromata	€ 766,00
cod.268.--/IDKNAN black painted/verniciato nero	€ 806,00
cod.268.--/IDKNAB white painted/verniciato bianco	€ 806,00
cod.268.--/IDKNA21 painted/verniciata	€ 806,00
cod.268.--/IDKNA22 painted/verniciata	€ 806,00
cod.268.--/IDKNA35 painted/verniciata	€ 806,00
cod.268.--/IDKNA54 painted/verniciata	€ 806,00
cod.268.--/IENA chromed/cromata	€ 580,00
cod.268.--/IENAN black painted/verniciato nero	€ 618,00
cod.268.--/IENAB white painted/verniciato bianco	€ 618,00
cod.268.--/IENA21 painted/verniciata	€ 618,00
cod.268.--/IENA22 painted/verniciata	€ 618,00
cod.268.--/IENA35 painted/verniciata	€ 618,00
cod.268.--/IENA54 painted/verniciata	€ 618,00
cod.268/ITCNA chromed/cromata	€ 528,00
cod.268/ITCNA- painted/verniciata	€ 562,00

Fabric required
Fabbisogno di tessuto
1 pcs: Lin Mtrs 1,3 (h1,40)

COM fabric min. order
10pcs each code
Tessuto cliente TC ordine
min. 10pz per codice

Min. order 4pcs
each code
Ordine min 4pz
per codice

BASKET CHAIR ST UPHOLSTERED



Upholstered PU-FLEX shell,
chromed or painted metal frame.
Scocca in PU-FLEX rivestita,
telaio in metallo cromato o verniciato.



NA not assembled / non assemblato



0,24 m³ - 9,2 kg.
66x55x63cm.
1 pcs (carton)

Frame Finishing & Codes / Finiture Telaie e Codici

cod.268.--/IBST chromed/cromata	€ 714,00
cod.268.--/IBSTN black painted/verniciato nero	€ 742,00
cod.268.--/IKST chromed/cromata	€ 598,00
cod.268.--/IKSTN black painted/verniciato nero	€ 626,00
cod.268.--/ISST chromed/cromata	€ 714,00
cod.268.--/ISSTN black painted/verniciato nero	€ 742,00
cod.268.--/IDKST chromed/cromata	€ 786,00
cod.268.--/IDKSTN black painted/verniciato nero	€ 812,00
cod.268.--/IEST chromed/cromata	€ 598,00
cod.268.--/IESTN black painted/verniciato nero	€ 626,00
cod.268/ITCST chromed/cromata	€ 544,00
cod.268/ITCSTN black painted/verniciato nero	€ 574,00

Fabric required
Fabbisogno di tessuto
1 pcs: Lin Mtrs 1,3 (h1,40)

COM fabric min. order
10pcs each code
Tessuto cliente TC ordine
min. 10pz per codice

Min. order 4pcs
each code
Ordine min 4pz
per codice

BASKET CHAIR CTL UPHOLSTERED



Upholstered PU-FLEX shell, chromed or painted metal frame. Scocca in PU-FLEX rivestita, telaio in metallo cromato o verniciato.

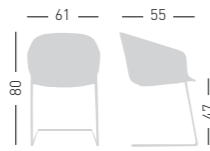

NA not assembled / non assemblato

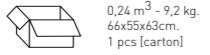

0,24 m³ - 9,2 kg.
66x55x63cm.
1 pcs [carton]

Frame Finishing & Codes / Finiture Telaie e Codici

cod.268.--/IBCTL chromed/cromata	€ 720,00
cod.268.--/IBCTLN black painted/verniciato nero	€ 746,00
cod.268.--/IKCTL chromed/cromata	€ 602,00
cod.268.--/IKCTLN black painted/verniciato nero	€ 630,00
cod.268.--/ISCTL chromed/cromata	€ 720,00
cod.268.--/ISCTLN black painted/verniciato nero	€ 746,00
cod.268.--/IDKCTL chromed/cromata	€ 790,00
cod.268.--/IDKCTLN black painted/verniciato nero	€ 814,00
cod.268.--/IECTL chromed/cromata	€ 602,00
cod.268.--/IECTLN black painted/verniciato nero	€ 630,00
cod.268./ITCCTL chromed/cromata	€ 550,00
cod.268./ITCCTLN black painted/verniciato nero	€ 578,00

Fabric required
Fabbisogno di tessuto
1 pcs: Lin Mtrs 1,3 (h1,40)

COM fabric min. order
10pcs each code
Tessuto cliente TC ordine
min. 10pz per codice

Min. order 4pcs
each code
Ordine min 4pz
per codice

BASKET CHAIR BP UPHOLSTERED



Upholstered PU-FLEX shell, metal-polymer co-injected frame. Scocca in PU-FLEX rivestita, telaio 4 gambe co-iniettate metallo-polimero.

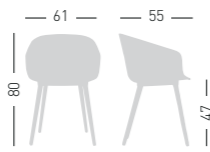

NA not assembled / non assemblato

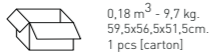

0,18 m³ - 9,7 kg.
59,5x56,5x51,5cm.
1 pcs [carton]

Available Legs Color / Colori disponibili Gambe

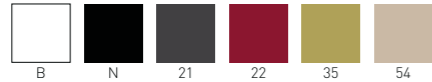

Frame Finishing & Codes / Finiture Telaie e Codici

cod.268.--/IBBP--	€ 838,00
cod.268.--/IKBP--	€ 720,00
cod.268.--/ISBP--	€ 838,00
cod.268.--/IDKBP--	€ 910,00
cod.268.--/IEBP--	€ 720,00
cod.268./ITCBP--	€ 668,00

Fabric required
Fabbisogno di tessuto
1 pcs: Lin Mtrs 1,3 (h1,40)

COM fabric min. order
10pcs each code
Tessuto cliente TC ordine
min. 10pz per codice

Min. order 4pcs
each code
Ordine min 4pz
per codice

BASKET CHAIR BL UPHOLSTERED



Upholstered PU-FLEX shell, beech wooden frame. Scocca in PU-FLEX rivestita, telaio in legno di faggio.

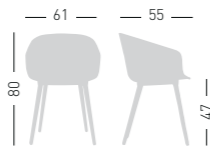

NA not assembled / non assemblato

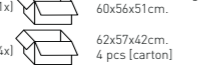

0,78 m³ - 41,00 kg.
60x56x51cm.
(1x)

62x57x42cm.
4 pcs [carton]
(4x)

Price + € 20,00



Frame Finishing & Codes / Finiture Telaie e Codici

cod.268.--/IBBL_	€ 878,00
cod.268.--/IKBL_	€ 760,00
cod.268.--/ISBL_	€ 878,00
cod.268.--/IDKBL_	€ 948,00
cod.268.--/IEBL_	€ 760,00
cod.268./ITCBL_	€ 708,00

Felt Glides / Tappi in feltro

Fabric required
Fabbisogno di tessuto
1 pcs: Lin Mtrs 1,3 (h1,40)

COM fabric min. order
10pcs each code
Tessuto cliente TC ordine
min. 10pz per codice

Min. order 4pcs
each code
Ordine min 4pz
per codice

BASKET CHAIR UR UPHOLSTERED



Upholstered PU-FLEX shell, aluminium base with castors. Scocca in PU-FLEX rivestita, base in alluminio con ruote.

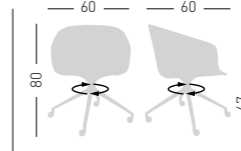

NA not assembled / non assemblato

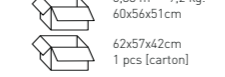

0,33 m³ - 9,2 kg.
60x56x51cm.
1 pcs [carton]

Frame Finishing & Codes / Finiture Telaie e Codici

cod.268.--/IBURL polished/lucido	€ 936,00
cod.268.--/IBURB white/bianco	€ 908,00
cod.268.--/IBURN black/nero	€ 908,00
cod.268.--/IKURL polished/lucido	€ 814,00
cod.268.--/IKURB white/bianco	€ 790,00
cod.268.--/IKURN black/nero	€ 790,00
cod.268.--/ISURL polished/lucido	€ 936,00
cod.268.--/ISURB white/bianco	€ 908,00
cod.268.--/ISURN black/nero	€ 908,00
cod.268.--/IDKURL polished/lucido	€ 1.006,00
cod.268.--/IDKURB white/bianco	€ 978,00
cod.268.--/IDKURN black/nero	€ 978,00
cod.268.--/IEURL polished/lucido	€ 814,00
cod.268.--/IEURB white/bianco	€ 790,00
cod.268.--/IEURN black/nero	€ 790,00
cod.268./ITCURL polished/lucido	€ 762,00
cod.268./ITCURB white/bianco	€ 738,00
cod.268./ITCURN black/nero	€ 738,00

Fabric required
Fabbisogno di tessuto
1 pcs: Lin Mtrs 1,3 (h1,40)

COM fabric min. order
10pcs each code
Tessuto cliente TC ordine
min. 10pz per codice

Min. order 4pcs
each code
Ordine min 4pz
per codice

BASKET PL UPHOLSTERED



4-legged wooden swivel base with solid Oak spokes reinforced with inner steel structure, techno-polymer shell and upholstered cushion. Base girevole con quattro razze in rovere massello rinforzate con struttura in acciaio interna, scocca in tecnopolimero e cuscino tappezzato.

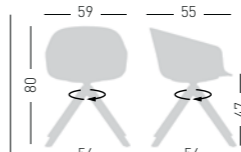

A assembled / assemblato



0,30 m³ - 12,5 kg.
54x60x92cm.
1 pc [carton]

Frame Finishing & Codes / Finiture Telaie e Codici

cod. 268._/IKPLRN Oak/Rovere	€ 1.044,00
cod. 268._/IBPLRN Oak/Rovere	€ 1.110,00
cod. 268._/ISPLRN Oak/Rovere	€ 1.044,00
cod. 268._/IDKPLRN Oak/Rovere	€ 1.214,00
cod. 268._/IEPLRN Oak/Rovere	€ 1.044,00
cod. 268./ITCPLRN Oak/Rovere	€ 990,00

Fabric required
Fabbisogno di tessuto
1 pc: Lin Mtrs 1,3 (h1,40)

COM fabric min. order
10pcs each code
Tessuto cliente TC ordine
min. 10pz per codice

Min. order 4pcs
each code
Ordine min 4pz
per codice

Oak Essence / Essenza Rovere



BASKET CHAIR U UPHOLSTERED



Upholstered PU-FLEX shell, aluminium base. Scocca in PU-FLEX rivestita, base in alluminio.

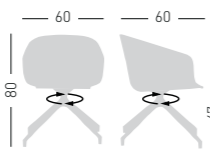

NA not assembled / non assemblato

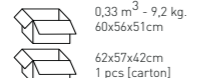

0,33 m³ - 9,2 kg.
60x56x51cm.
1 pcs [carton]

Frame Finishing & Codes / Finiture Telaie e Codici

cod.268.--/IBUL polished/lucido	€ 908,00
cod.268.--/IBUB white/bianco	€ 882,00
cod.268.--/IBUN black/nero	€ 882,00
cod.268.--/IKUL polished/lucido	€ 790,00
cod.268.--/IKUB white/bianco	€ 762,00
cod.268.--/IKUN black/nero	€ 762,00
cod.268.--/ISUL polished/lucido	€ 908,00
cod.268.--/ISUB white/bianco	€ 882,00
cod.268.--/ISUN black/nero	€ 882,00
cod.268.--/IDKUL polished/lucido	€ 978,00
cod.268.--/IDKUB white/bianco	€ 950,00
cod.268.--/IDKUN black/nero	€ 950,00
cod.268.--/IEUL polished/lucido	€ 790,00
cod.268.--/IEUB white/bianco	€ 762,00
cod.268.--/IEUN black/nero	€ 762,00
cod.268./ITCUL polished/lucido	€ 738,00
cod.268./ITCUB white/bianco	€ 710,00
cod.268./ITCUN black/nero	€ 710,00

Felt Glides / Tappi in feltro

Fabric required
Fabbisogno di tessuto
1 pcs: Lin Mtrs 1,3 (h1,40)

COM fabric min. order
10pcs each code
Tessuto cliente TC ordine
min. 10pz per codice

Min. order 4pcs
each code
Ordine min 4pz
per codice



Beverly

Available colors / Colori disponibili

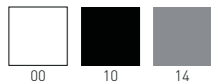

BEVERLY

Shell in techno-polymer and anodized aluminum legs. Scocca in tecnopolimero e gambe in alluminio anodizzato.



stackable / impilabile (5pcs)
A assembled / assemblato

0,41 m³ - 15,2 kg.
95x73x60,5cm.
4 pcs (carton)

Frame Finishing & Codes / Finiture Telai e Codici

cod.35.--/A

€ 106,00



Big Bang

Available colors / Colori disponibili

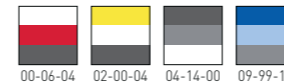

BIG BANG

Chromed or white painted 4-Legged metal frame, techno-polymer multicolor shell. Struttura in metallo 4 gambe, cromata o verniciata bianca, scocca in tecnopolimero multicolore.



only for painted frames
solo per telai verniciati

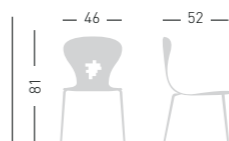

stackable / impilabile (5pcs)
A assembled / assemblato

0,30 m³ - 20 kg.
61x55x96cm.
4 pz. (carton)

Frame Finishing & Codes / Finiture Telai e Codici

cod.93.--/A chromed/cromata

cod.93.--/AB white painted/verniciato bianco

€ 212,00
€ 244,00

Blog



Available colors / Colori disponibili

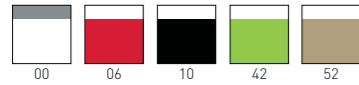

BLOG



Chromed or white painted 4-Legged metal frame, techno-polymer multicolor shell.
Struttura in metallo 4 gambe, cromata o verniciata bianca, scocca in tecnopolimero multicolore.



only for paintend frames
solo per telai verniciati

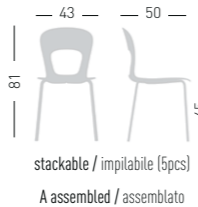

Frame Finishing & Codes / Finiture Telai e Codici

cod.144.--/A chromed/cromata
cod.144.--/AB white painted/verniciato bianco

€ 190,00
€ 226,00

BLOG TB



Chromed 4-Legged metal frame with armrests, techno-polymer multicolor shell.
Struttura in metallo 4 gambe con braccioli, cromata, scocca in tecnopolimero multicolore.



only for paintend frames
solo per telai verniciati

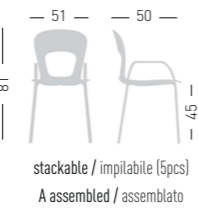

Frame Finishing & Codes / Finiture Telai e Codici

cod.144.--/TB chromed/cromata

€ 232,00

BLOG BL



4-Legged wooden beech frame, techno-polymer multicolor shell.
Struttura in legno di faggio 4 gambe, scocca in tecnopolimero multicolore.



Price + € 20,00

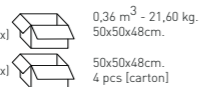
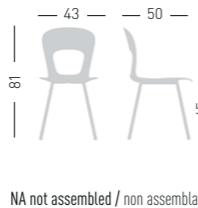

Frame Finishing & Codes / Finiture Telai e Codici

cod.144.--/BL_

Felt Glides / Tappi in feltro

€ 352,00

BLOG UPHOLSTERED IMBOTTITE

Available fabric / Tessuti disponibili
Leather / Pelle **P** (4pcs min.)
King fabric / Tessuto King **K** (4pcs min.)
COM fabric / Tessuto cliente **TC** (10pcs min.)

BLOG NA UPHOLSTERED



Techno-polymer shell upholstered by King fabric or leather. Chromed or painted metal frame.
Scocca in tecnopolimero rivestito in tessuto King o pelle. Telaio in metallo cromato o verniciato.

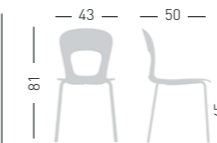

A assembled / assemblato



Frame Finishing & Codes / Finiture Telai e Codici

cod.175.--/IPNA chromed/cromata
cod.175.--/IKNA chromed/cromata
cod.175.--/ITCNA chromed/cromata
cod.175.--/IPNAB white painted/verniciato bianco
cod.175.--/IKNAB white painted/verniciato bianco
cod.175./ITCNAB white painted/verniciato bianco

€ 676,00
€ 558,00
€ 504,00
€ 716,00
€ 596,00
€ 540,00

Fabric required
Fabbisogno di tessuto
1 pcs: Lin Mtrs 1,3 (h1,40)

COM fabric min. order 10pcs each code
Tessuto cliente TC ordine min. 10pz per codice
Min. order 4pcs each code
Ordine min 4pz per codice

BLOG TB UPHOLSTERED



Techno-polymer shell upholstered by King fabric or leather. Chromed metal frame with arms.
Scocca in tecnopolimero rivestito in tessuto King o pelle. Telaio in metallo cromato con braccioli.



A assembled / assemblato



Frame Finishing & Codes / Finiture Telai e Codici

cod.175.--/IPTB chromed/cromata
cod.175.--/IKTB chromed/cromata
cod.175./ITCTB chromed/cromata

€ 718,00
€ 600,00
€ 542,00

Fabric required
Fabbisogno di tessuto
1 pcs: Lin Mtrs 1,3 (h1,40)

COM fabric min. order 10pcs each code
Tessuto cliente TC ordine min. 10pz per codice
Min. order 4pcs each code
Ordine min 4pz per codice

BLOG BL UPHOLSTERED



Techno-polymer shell upholstered by King fabric or leather and beech wooden legs.
Scocca in tecnopolimero rivestito in tessuto King o pelle e gambe in legno di faggio.



NA not assembled / non assemblato

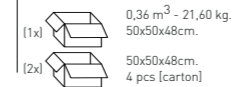

Frame Finishing & Codes / Finiture Telai e Codici

cod.175.--/IPBL_
cod.175.--/IKBL_
cod.175./ITCBL_

€ 806,00
€ 690,00
€ 634,00

Felt Glides / Tappi in feltro

Fabric required
Fabbisogno di tessuto
1 pcs: Lin Mtrs 1,3 (h1,40)

COM fabric min. order 10pcs each code
Tessuto cliente TC ordine min. 10pz per codice
Min. order 4pcs each code
Ordine min 4pz per codice

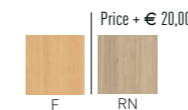

Chevalet



Products follows UNI 9175 -UNI 9175/FA, in terms of Fire Resistance, Fire Reation Class 11M
Prodotto Omologato dal Ministero dell'Interno, secondo la UNI 9175 -UNI 9175/FA, con classe di Reazione al fuoco 11M



Available fabric / Tessuti disponibili
Blazer fabric / Tessuto Blazer **B** (4pcs min.)
Leather / Pelle **P** (4pcs min.)
King fabric / Tessuto King **K** (4pcs min.)
Kvadrat fabrics / Tessuti Kvadrat **DK** (4pcs min.)
COM fabric / Tessuto cliente **TC**

CHEVALET BL

PU-FLEX shell upholstered by King, Blazer, Kvadrat fabric or leather and wooden beech legs.
Scocca PU-FLEX rivestita in tessuto King, Blazer, Kvadrat o pelle, gambe in legno di faggio.

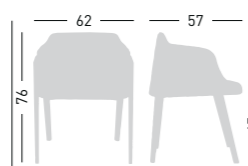

A assembled / assemblato



0,29 m³ - 11 kg.
63x57x80cm.
1 pc [carton]

Frame Finishing & Codes / Finiture Telai e Codici

cod.248.--/IBBLF beech/faggio
cod.248.--/IKBLF beech/faggio
cod.248.--/IDKBLF beech/faggio
cod.248.--/IPBLF beech/faggio
cod.248/ITCBLF beech/faggio

Felt Glides / Tappi in feltro

specify edge color
specificare il colore del bordo

Fabric required
Fabbisogno di tessuto
1 pcs: Lin Mtrs 1,8 (h1,40)

COM fabric min. order
10pcs each code
Tessuto cliente TC ordine
min. 10pz per codice

Min. order 4pcs
each code
Ordine min 4pz
per codice

€ 1.206,00
€ 1.096,00
€ 1.296,00
€ 1.296,00
€ 1.020,00

Choppy



Available coverings / Finiture disponibili
Miki fabric / Tessuto Miki **M** (4pcs min.)
King fabric / Tessuto King **K** (4pcs min.)
Kvadrat fabrics / Tessuti Kvadrat **DK** (4pcs min.)
Silvertex Fabric / Tessuto Silvertex **SX** (4pcs min.)

CHOPPY BL

Techno-polymer upholstered chair,
4-Legged wooden beech frame.
Seduta in tecnopolimero rivestita,
struttura in legno di faggio 4 gambe.

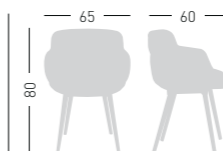

NA not assembled / non assemblato
0,42 m³ - 36,00 kg.
66x55x63cm.
60x56x51cm.
4 pcs [carton]

Frame Finishing & Codes / Finiture Telai e Codici

cod.390.00----/IMBL_ white/bianca
cod.390.10----/IMBL_ black/nera
cod.390.00----/IKBL_ white/bianca
cod.390.10----/IKBL_ black/nera
cod.390.00----/ISXBL_ white/bianca
cod.390.10----/ISXBL_ black/nera
cod.390.00----/IDKBL_ white/bianca
cod.390.10----/IDKBL_ black/nera

Felt Glides / Tappi in feltro

Price + € 20,00



Cushion-edge color combined with the shell
Colore del bordo cuscino uguale al colore scocca

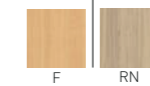

€ 960,00
€ 960,00
€ 960,00
€ 960,00
€ 960,00
€ 1.230,00
€ 1.230,00

Min. order 4pcs
each code
Ordine min 4pz
per codice

CHOPPY BP

Techno-polymer upholstered chair,
4 polymer-steel co-injected legs
structure.
Seduta in tecnopolimero rivestita,
struttura 4 gambe in co-iniezione
metallo-polimero.

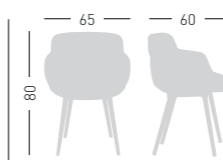

NA not assembled / non assemblato
0,24 m³ - 20 kg.
66x55x63cm.
2 pcs [carton]

Frame Finishing & Codes / Finiture Telai e Codici

cod.390.00----/IMBP00 white/bianca
cod.390.10----/IMBP10 black/nera
cod.390.00----/IKBP00 white/bianca
cod.390.10----/IKBP10 black/nera
cod.390.00----/ISXBP00 white/bianca
cod.390.10----/ISXBP10 black/nera
cod.390.00----/IDKBP00 white/bianca
cod.390.10----/IDKBP10 black/nera



only for Miki and Silvertex fabrics
solo per tessuto Miki e Silvertex

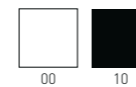

Cushion-edge color combined with the shell
Colore del bordo cuscino uguale al colore scocca

Price + € 20,00

€ 932,00
€ 932,00
€ 932,00
€ 932,00
€ 932,00
€ 1.204,00
€ 1.204,00

Min. order 4pcs
each code
Ordine min 4pz
per codice

CHOPPY U

Techno-polymer upholstered chair,
swivel on 4-blade, with glides.
Seduta in tecnopolimero rivestita,
girevole su basamento a 4 razze su
piedini.

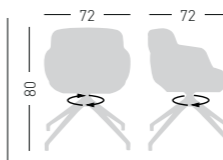

NA not assembled / non assemblato
0,42 m³ - 26 kg.
60x56x51cm.
66x55x63cm.
2 pcs [carton]

Frame Finishing & Codes / Finiture Telai e Codici

cod.390.00----/IMUB white/bianca
cod.390.10----/IMUN black/nera
cod.390.00----/IKUB white/bianca
cod.390.10----/IKUN black/nera
cod.390.00----/ISXUB white/bianca
cod.390.10----/ISXUN black/nera
cod.390.00----/IDKUB white/bianca
cod.390.10----/IDKUN black/nera



Cushion-edge color combined with the shell
Colore del bordo cuscino uguale al colore scocca

Felt Glides / Tappi in feltro

€ 966,00
€ 966,00
€ 966,00
€ 966,00
€ 966,00
€ 1.238,00
€ 1.238,00

Min. order 4pcs
each code
Ordine min 4pz
per codice

CHOPPY UR



Techno-polymer upholstered chair, swivel on 4-blade, with castors. Seduta in tecnopolimero rivestita, girevole su basamento a 4 razze su ruote.

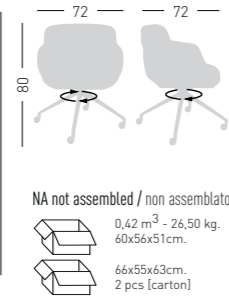

NA not assembled / non assemblato
0,42 m³ - 26,50 kg.
60x56x51cm.
66x55x63cm.
2 pcs [carton]

Frame Finishing & Codes / Finiture Telai e Codici

cod.390.00- ----/IMURB white/bianca
cod.390.10- ----/IMURN black/nera
cod.390.00- ----/IKURB white/bianca
cod.390.10- ----/IKURN black/nera
cod.390.00- ----/ISXURB white/bianca
cod.390.10- ----/ISXURN black/nera
cod.390.00- ----/IDKURB white/bianca
cod.390.10- ----/IDKURN black/nera

€ 986,00
€ 986,00
€ 986,00
€ 986,00
€ 986,00
€ 1.256,00
€ 1.256,00

Min. order 4pcs
each code
Ordine min 4pz
per codice

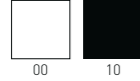

Cushion-edge color combined with the shell
Colore del bordo cuscino uguale al colore scocca

CHOPPY PL



Techno-polymer upholstered chair, 4-legged wooden swivel base with solid Oak spokes reinforced with inner steel structure. Seduta in tecnopolimero rivestita, base girevole con quattro razze in rovere massello, rinforzate con struttura interna in acciaio.

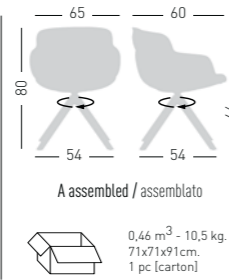

A assembled / assemblato
0,46 m³ - 10,5 kg.
71x71x91cm.
1 pc [carton]

Frame Finishing & Codes / Finiture Telai e Codici

cod. 390.00- ___/IMPLRN white/bianca
cod. 390.10- ___/IMPLRN black/nera
cod. 390.00- ___/IKPLRN white/bianca
cod. 390.10- ___/IKPLRN black/nera
cod. 390.00- ___/ISXPLRN white/bianca
cod. 390.10- ___/ISXPLRN black/nera
cod. 390.00- ___/IDKPLRN white/bianca
cod. 390.10- ___/IDKPLRN black/nera

€ 1.040,00
€ 1.040,00
€ 1.040,00
€ 1.040,00
€ 1.040,00
€ 1.162,00
€ 1.162,00

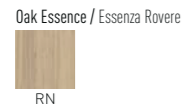

Oak Essence / Essenza Rovere

Choppy Sleek



Available coverings / Finiture disponibili
Blazer fabric / Tessuto Blazer **B** (4pcs min.)
Aurea eco-leather / Ecopelle aurea **E** (4pcs min.)
King fabric / Tessuto King **K** (4pcs min.)
Kvadrat fabrics / Tessuti Kvadrat **DK** (4pcs min.)
COM fabric / Tessuto cliente **TC** (10pcs min.)

Products follows UNI 9175 -UNI 9175/FA, in terms of Fire Resistance, Fire Reation Class 11M
Prodotto Omologato dal Ministero dell'Interno, secondo la UNI 9175 -UNI 9175/FA, con classe di Reazione al fuoco 11M



CHOPPY SLEEK BL



Techno-polymer upholstered chair, 4-Legged wooden beech frame. Seduta in tecnopolimero rivestita, struttura in legno di faggio 4 gambe.

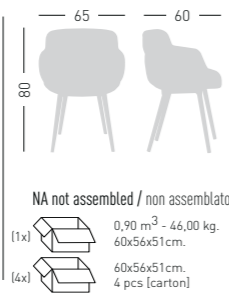

NA not assembled / non assemblato
(1x) 0,90 m³ - 46,00 kg.
60x56x51cm.
(4x) 60x56x51cm.
4 pcs [carton]

Frame Finishing & Codes / Finiture Telai e Codici

cod.391.00- ----/IBBL_ white/bianca
cod.391.10- ----/IBBL_ black/nera
cod.391.00- ----/IKBL_ white/bianca
cod.391.10- ----/IKBL_ black/nera
cod.391.00- ----/IEBL_ white/bianca
cod.391.10- ----/IEBL_ black/nera
cod.391.00- ----/IDKBL_ white/bianca
cod.391.10- ----/IDKBL_ black/nera
cod. 391.00/ITCBL_ COM fabric/tessuto cliente
cod. 391.10/ITCBL_ COM fabric/tessuto cliente

€ 1.026,00
€ 1.026,00
€ 960,00
€ 960,00
€ 960,00
€ 960,00
€ 1.230,00
€ 1.230,00
€ 894,00
€ 894,00

Felt Glides / Tappi in feltro
Fabric required
Fabbisogno di tessuto
1 pcs: Lin Mtrs 0,90 [h1,40]

COM fabric min. order
10pcs each code
Tessuto cliente TC ordine
min. 10pz per codice
Min. order 4pcs
each code
Ordine min 4pz
per codice



Price + € 20,00

CHOPPY SLEEK BP



Techno-polymer upholstered chair, 4 polymer-steel co-injected legs structure. Seduta in tecnopolimero rivestita, struttura 4 gambe in co-iniezione metallo-polimero.

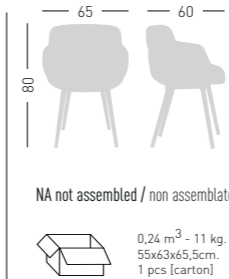

NA not assembled / non assemblato
0,24 m³ - 11 kg.
55x63x65,5cm.
1 pcs [carton]



CATAS
TESTATO - TESTED

Frame Finishing & Codes / Finiture Telai e Codici

cod.391.00- ----/IBBP00 white/bianca
cod.391.10- ----/IBBP10 black/nera
cod.391.00- ----/IKBP00 white/bianca
cod.391.10- ----/IKBP10 black/nera
cod.391.00- ----/IEBP00 white/bianca
cod.391.10- ----/IEBP10 black/nera
cod.391.00- ----/IDKBP00 white/bianca
cod.391.10- ----/IDKBP10 black/nera
cod.391.00/ITCBP00 COM fabric/tessuto cliente
cod.391.10/ITCBP10 COM fabric/tessuto cliente

€ 998,00
€ 998,00
€ 932,00
€ 932,00
€ 932,00
€ 932,00
€ 1.204,00
€ 1.204,00
€ 866,00
€ 866,00

Fabric required
Fabbisogno di tessuto
1 pcs: Lin Mtrs 0,90 [h1,40]

COM fabric min. order
10pcs each code
Tessuto cliente TC ordine
min. 10pz per codice

Min. order 4pcs
each code
Ordine min 4pz
per codice

CHOPPY SLEEK U



Techno-polymer upholstered chair, swivel on 4-blade, with glides. Seduta in tecnopolimero rivestita, girevole su basamento a 4 razze su piedini.

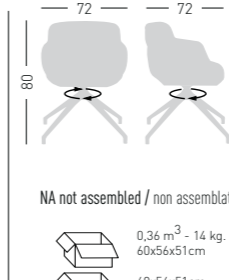

NA not assembled / non assemblato
0,36 m³ - 14 kg.
60x56x51cm.
60x56x51cm.
1 pcs [carton]



Frame Finishing & Codes / Finiture Telai e Codici

cod.391.00- ----/IBUB white/bianca
cod.391.10- ----/IBUN black/nera
cod.391.00- ----/IKUB white/bianca
cod.391.10- ----/IKUN black/nera
cod.391.00- ----/IEUB white/bianca
cod.391.10- ----/IEUN black/nera
cod.391.00- ----/IDKUB white/bianca
cod.391.10- ----/IDKUN black/nera
cod. 391.00/ITCUB COM fabric/tessuto cliente
cod. 391.10/ITCUN COM fabric/tessuto cliente

€ 1.034,00
€ 1.034,00
€ 966,00
€ 966,00
€ 966,00
€ 966,00
€ 1.238,00
€ 1.238,00
€ 900,00
€ 900,00

Felt Glides / Tappi in feltro
Fabric required
Fabbisogno di tessuto
1 pcs: Lin Mtrs 0,90 [h1,40]

COM fabric min. order
10pcs each code
Tessuto cliente TC ordine
min. 10pz per codice

Min. order 4pcs
each code
Ordine min 4pz
per codice

CHOPPY SLEEK UR



Techno-polymer upholstered chair, swivel on 4-blade, with castors. Seduta in tecnopolimero rivestita, girevole su basamento a 4 razze su ruote.

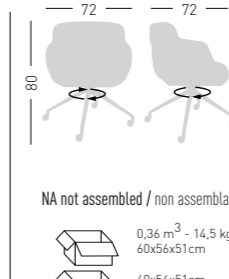

NA not assembled / non assemblato
0,36 m³ - 14,5 kg.
60x56x51cm.
60x56x51cm.
1 pcs [carton]

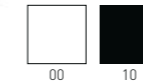

Frame Finishing & Codes / Finiture Telai e Codici

cod.391.00- ----/IBURB white/bianca
cod.391.10- ----/IBURN black/nera
cod.391.00- ----/IKURB white/bianca
cod.391.10- ----/IKURN black/nera
cod.391.00- ----/IEURB white/bianca
cod.391.10- ----/IEURN black/nera
cod.391.00- ----/IDKURB white/bianca
cod.391.10- ----/IDKURN black/nera
cod. 391.00/ITCURB COM fabric/tessuto cliente
cod. 391.10/ITCURN COM fabric/tessuto cliente

€ 1.054,00
€ 1.054,00
€ 986,00
€ 986,00
€ 986,00
€ 986,00
€ 1.256,00
€ 1.256,00
€ 920,00
€ 920,00

Fabric required
Fabbisogno di tessuto
1 pcs: Lin Mtrs 0,90 [h1,40]

COM fabric min. order
10pcs each code
Tessuto cliente TC ordine
min. 10pz per codice

Min. order 4pcs
each code
Ordine min 4pz
per codice

CHOPPY SLEEK PL



Techno-polymer upholstered chair, 4-legged wooden swivel base with solid Oak spokes reinforced with inner steel structure. Seduta in tecnopolimero rivestita, base girevole con quattro razze in rovere massello, rinforzate con struttura interna in acciaio.

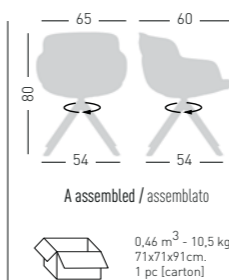

A assembled / assemblato
0,46 m³ - 10,5 kg.
71x71x91cm.
1 pc [carton]

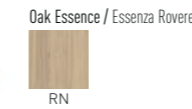

Oak Essence / Essenza Rovere

Frame Finishing & Codes / Finiture Telai e Codici

cod. 391.00- ___/IBPLRN white/bianca
cod. 391.10- ___/IBPLRN black/nera
cod. 391.00- ___/IKPLRN white/bianca
cod. 391.10- ___/IKPLRN black/nera
cod. 391.00- ___/IEPLRN white/bianca
cod. 391.10- ___/IEPLRN black/nera
cod. 391.00- ___/IDKPLRN white/bianca
cod. 391.10- ___/IDKPLRN black/nera
cod. 391.00/ITCPLRN COM fabric/tessuto cliente
cod. 391.10/ITCPLRN COM fabric/tessuto cliente

€ 1.108,00
€ 1.108,00
€ 1.026,00
€ 1.026,00
€ 1.026,00
€ 1.026,00
€ 1.206,00
€ 1.206,00
€ 992,00
€ 992,00

Fabric required
Fabbisogno di tessuto
4 pcs: Lin Mtrs 1,3 [h1,40]

COM fabric min. order
10pcs each code
Tessuto cliente TC ordine
min. 10pz per codice

Min. order 4pcs
each code
Ordine min 4pz
per codice

Clipperton



Available colors / Colori disponibili

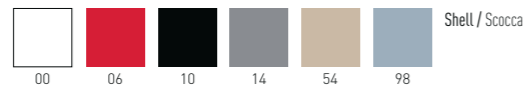
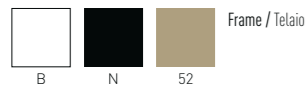

CLIPPERTON

4-legged stackable techno-polymer chair. Seduta impilabile in tecnopolimero.

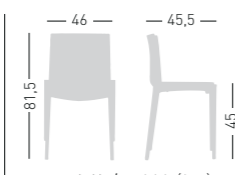

stackable / impilabile (6pcs)

A assembled / assemblato



0,36 m³ - 21,10 kg.
58x64x98cm.
4 pcs [carton]

Frame Finishing & Codes / Finiture Telaie e Codici

cod.230.--/TPB white frame/telaio bianco
cod.230.--/TPN black frame/telaio nero
cod.230.--/TP52 turtledove frame/telaio tortora

€ **166,00**
€ **166,00**
€ **166,00**

CLIPPERTON B

4-legged stackable techno-polymer chair with armrests. Seduta impilabile in tecnopolimero con braccioli.

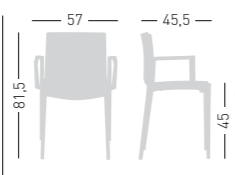

stackable / impilabile (6pcs)

A assembled / assemblato



0,36 m³ - 23,50 kg.
58x64x98cm.
4 pcs [carton]

Frame Finishing & Codes / Finiture Telaie e Codici

cod.231.--/TPB white frame/telaio bianco
cod.231.--/TPN black frame/telaio nero
cod.231.--/TP52 turtledove frame/telaio tortora

€ **184,00**
€ **184,00**
€ **184,00**

DRESS CLIPPERTON UPHOLSTERED IMBOTTITE

Available fabric / Tessuti disponibili
Aurea eco-leather / Ecopelle aurea **E** (4pcs min.)
King fabric / Tessuto King **K** (4pcs min.)
Blazer fabric / Tessuto Blazer **B** (4pcs min.)
Kvadrat fabrics / Tessuti Kvadrat **DK** (4pcs min.)
COM fabric / Tessuto cliente **TC** (10pcs min.)

DRESS CLIPPERTON

Techno-polymer upholstered chair. Seduta in tecnopolimero rivestita.

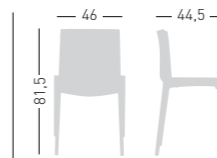

A assembled / assemblato



0,36 m³ - 12,10 kg.
58x64x98cm.
2 pcs [carton]

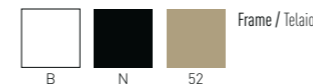

Frame Finishing & Codes / Finiture Telaie e Codici

cod.230.--/IKTP--
cod.230.--/IETP--
cod.230.--/IBTP--
cod.230.--/IDKTP--
cod.230.--/ITCTP--

€ **396,00**
€ **396,00**
€ **440,00**
€ **512,00**
€ **392,00**

Fabric required
Fabbisogno di tessuto
1 pcs: Lin Mtrs 0,90 (h1,40)

COM fabric min. order
10pcs each code
Tessuto cliente TC ordine
min. 10pz per codice

Min. order 4pcs
each code
Ordine min 4pz
per codice

DRESS CLIPPERTON B

Techno-polymer upholstered chair with armrests. Seduta in tecnopolimero rivestita con braccioli.

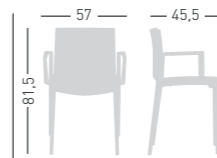

A assembled / assemblato



0,36 m³ - 13,30 kg.
58x64x98cm.
2 pcs [carton]



Frame Finishing & Codes / Finiture Telaie e Codici

cod.231.--/IKTP--
cod.231.--/IETP--
cod.231.--/IBTP--
cod.231.--/IDKTP--
cod.231.--/ITCTP--

€ **416,00**
€ **416,00**
€ **460,00**
€ **532,00**
€ **412,00**

Fabric required
Fabbisogno di tessuto
1 pcs: Lin Mtrs 0,90 (h1,40)

COM fabric min. order
10pcs each code
Tessuto cliente TC ordine
min. 10pz per codice

Min. order 4pcs
each code
Ordine min 4pz
per codice

Clipperton Blend



Available colors / Colori disponibili

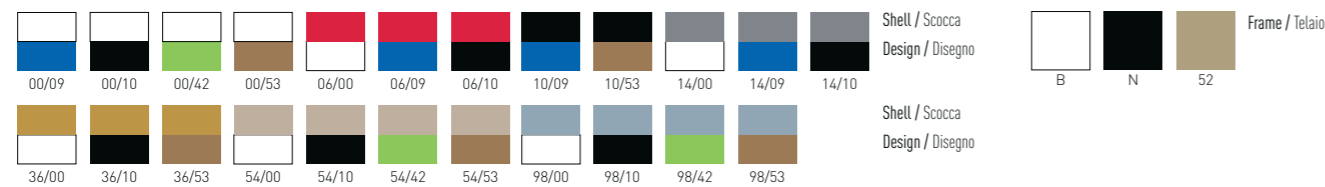

CLIPPERTON BLEND

4-legged stackable techno-polymer chair. Seduta impilabile in tecnopolimero.

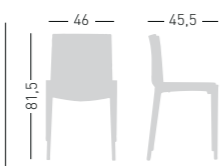

stackable / impilabile (6pcs)
A assembled / assemblato

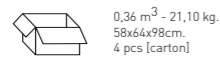

Frame Finishing & Codes / Finiture Telai e Codici

cod.230.____/TP--

€ 330,00

Min. order 20pcs each code
Ordine min 20pz per codice

CLIPPERTON BLEND B

4-legged stackable techno-polymer chair with armrests. Seduta impilabile in tecnopolimero con braccioli.

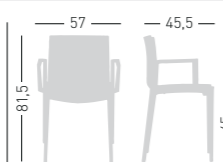

stackable / impilabile (6pcs)
A assembled / assemblato



Frame Finishing & Codes / Finiture Telai e Codici

cod.231.____/TP--

€ 348,00

Min. order 20pcs each code
Ordine min 20pz per codice

Colorfive



Available colors / Colori disponibili

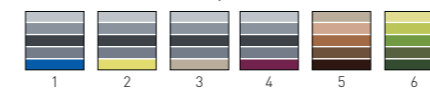

COLORFIVE NA



Chromed, black or white painted 4-Legged metal frame, techno-polymer multicolor shell. Struttura in metallo 4 gambe, cromata, verniciata nera o bianca, scocca in tecnopolimero multicolore.

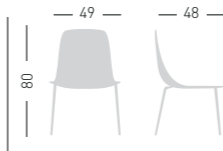

stackable / impilabile (5pcs)
NA not assembled / non assemblato



Frame Finishing & Codes / Finiture Telai e Codici

cod.135.--/NA chromed/cromata
cod.135.--/NAB white painted/verniciato bianco
cod.135.--/NAN black painted/verniciato nero

€ 352,00
€ 286,00
€ 286,00

COLORFIVE TB



Chromed or white painted 4-Legged metal frame with armrests, techno-polymer multicolor shell. Struttura in metallo 4 gambe con braccioli, cromata o verniciata bianca, scocca in tecnopolimero multicolore.



only for painted frames
solo per telai verniciati

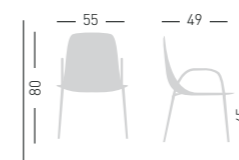

stackable / impilabile (4pcs)
NA not assembled / non assemblato



Frame Finishing & Codes / Finiture Telai e Codici

cod.135.--/TB chromed/cromata
cod.135.--/TBB white painted/verniciato bianco

€ 288,00
€ 430,00

COLORFIVE TC



Chromed or painted wire steel metal frame, techno-polymer multicolor shell. Struttura a traliccio in filo, cromata o verniciata, scocca in tecnopolimero multicolore.



only for painted frames
solo per telai verniciati

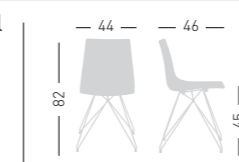

NA not assembled / non assemblato

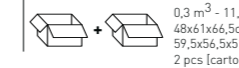



Frame Finishing & Codes / Finiture Telai e Codici

cod.135.--/TC chromed/cromata
cod.135.--/TCB white painted/verniciato bianco
cod.135.--/TCN black painted/verniciato nero

€ 368,00
€ 394,00
€ 394,00

COLORFIVE TP White techno-polymer 4-Legged frame, techno-polymer multicolor shell.
Struttura in tecnopolimero 4 gambe bianca, scocca in tecnopolimero multicolore.

49 48
80 45

stackable / impilabile (4pcs)
NA not assembled / non assemblato





0,24 m³ - 22 kg.
55x65,5x63cm.
4 pcs [carton]

Frame Finishing & Codes / Finiture Telai e Codici
cod.135.--/TPB white painted/verniciato bianco

€ **408,00**

COLORFIVE S Chromed, black or white painted wire steel sled frame, techno-polymer multicolor shell.
Struttura a slitta in filo, cromata, verniciata nera o bianca, scocca in tecnopolimero multicolore.

only for paintend frames
solo per telai verniciati

43 51
81 45

stackable / impilabile (6pcs)
NA not assembled / non assemblato





0,19 m³ - 25 kg.
49x69x68cm.
4 pcs [carton]

Frame Finishing & Codes / Finiture Telai e Codici
cod.135.--/S chromed/cromata
cod.135.--/SB white painted/verniciato bianco
cod.135.--/SN black painted/verniciato nero

€ **352,00**
€ **386,00**
€ **386,00**

COLORFIVE ST Chromed or painted sled steel frame, techno-polymer multicolor shell.
Struttura a slitta, cromata o verniciata, scocca in tecnopolimero multicolore.

only for paintend frames
solo per telai verniciati

43 51
81 45

stackable / impilabile (6pcs)
NA not assembled / non assemblato



0,24 m³ - 23,60 kg.
66x55x63cm.
4 pcs [carton]

Frame Finishing & Codes / Finiture Telai e Codici
cod.135.--/ST chromed/cromata
cod.135.--/STB white painted/verniciato bianco
cod.135.--/STN black painted/verniciato nero

€ **368,00**
€ **394,00**
€ **394,00**

COLORFIVE 5R Swivel on polished aluminum base with castors, height adjustable, techno-polymer multicolor shell.
Girevole su basamento in alluminio pulito con ruote, regolabile in altezza, scocca in tecnopolimero multicolore.



64 64
83 45

NA not assembled / non assemblato



0,24 m³ - 17 kg.
55x65,5x63cm.
2 pcs [carton]

Frame Finishing & Codes / Finiture Telai e Codici
cod.135.--/5R polished/lucida

€ **542,00**

COLORFIVE L Swivel on 4-spr polished aluminum base, techno-polymer multicolor shell.
Girevole su basamento 4 razze in alluminio pulito, scocca in tecnopolimero multicolore.



46 54
83 45

NA not assembled / non assemblato





0,24 m³ - 15 kg.
55x65,5x63cm.
2 pcs [carton]

Frame Finishing & Codes / Finiture Telai e Codici
cod.135.--/L polished/lucida

Felt Glides / Tappi in feltro

€ **542,00**

COLORFIVE CONNECTING SYSTEM GANCIO CONNESSIONE Set linking glides for in-line disposal. Set piedini con agganci per disporre le sedute in linea.

Inside chairs boxes
Nella scatola delle sedie.



Assembled / assemblato

Frame Finishing & Codes / Finiture Telai e Codici
cod.1012

available for models: S
disponibile per versioni: S

€ **20,00**

COLORFIVE CHAIRS TROLLEY CARRELLO PER SEDIE Trolley for chairs, chromed metal structure. Carrello porta sedie, struttura in metallo cromato.

0,3 m³ - 10kg
63x75x58cm.
1 pcs [carton]

Frame Finishing & Codes / Finiture Telai e Codici
cod.2000/A



available for models: S
disponibile per versioni: S

stackable on trolley 18 pcs
impilabili su carrello 18 pcs

max height with 18 chairs 178 cm
altezza carrello con 18 sedie 178 cm

€ **242,00**

COLORFIVE CHAIRS TROLLEY CARRELLO PER SEDIE Painted grey adjustable Dolly, for 4 legged chairs. Carrello per sedie 4 gambe, regolabile, verniciato grigio.

0,3 m³ - 8kg
62x72x51cm.
1 pcs [carton]

Frame Finishing & Codes / Finiture Telai e Codici
cod.2001/A

available for models: NA
disponibile per versioni: NA

€ **290,00**

COLORFIVE UPHOLSTERED IMBOTTITE

Available coverings / Finiture disponibili
Aurea eco-leather / Ecopelle aurea **E** (4pcs min.)
King fabric / Tessuto King **K** (4pcs min.)
Blazer fabric / Tessuto Blazer **B** (4pcs min.)
COM fabric / Tessuto cliente **TC** (10pcs min.)

COLORFIVE WRAP NA UPHOLSTERED Techno-polymer upholstered shell, chromed or painted metal frame. Scocca in tecnopolimero rivestita, telaio in metallo cromato o verniciato.



49 48
80 45

NA not assembled / non assemblato



0,24 m³ - 14,4 kg.
55x65,5x63cm.
2 pcs [carton]

Frame Finishing & Codes / Finiture Telai e Codici
cod.176.--/IENA chromed/cromata € **408,00**
cod.176.--/IKNA chromed/cromata € **408,00**
cod.176.--/IBNA chromed/cromata € **432,00**
cod.176/ITCNA chromed/cromata € **356,00**
cod.176.--/IENAB white painted/verniciato bianco € **438,00**
cod.176.--/IKNAB white painted/verniciato bianco € **438,00**
cod.176.--/IBNAB white painted/verniciato bianco € **462,00**
cod.176/ITCNAB white painted/verniciato bianco € **388,00**
cod.176.--/IENAN black painted/verniciato nero € **438,00**
cod.176.--/IKNAN black painted/verniciato nero € **438,00**
cod.176.--/IBNAN black painted/verniciato nero € **462,00**
cod.176/ITCNAN black painted/verniciato nero € **388,00**

Fabric required
Fabbisogno di tessuto
1 pcs: Lin Mtrs 1,0 [h1,40]

COM fabric min. order
10pcs each code
Tessuto cliente TC ordine
min. 10pz per codice

Min. order 4pcs
each code
Ordine min 4pz
per codice

**COLORFIVE
WRAP TB
UPHOLSTERED**



Techno-polymer upholstered shell, chromed or painted metal frame with arms.
Scocca in tecnopolimero rivestita, telaio in metallo cromato o verniciato con braccioli.

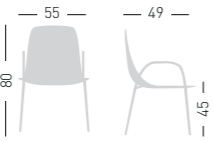

NA not assembled / non assemblato



Frame Finishing & Codes / Finiture Telai e Codici

cod.176.--/IETB chromed/cromata	€ 438,00
cod.176.--/IKTB chromed/cromata	€ 438,00
cod.176.--/IBTB chromed/cromata	€ 462,00
cod.176./ITCTB chromed/cromata	€ 388,00
cod.176.--/IETBB white painted/verniciato bianco	€ 484,00
cod.176.--/IKTBB white painted/verniciato bianco	€ 484,00
cod.176.--/IBTBB white painted/verniciato bianco	€ 508,00
cod.176./ITCTBB white painted/verniciato bianco	€ 434,00

Fabric required
Fabbisogno di tessuto
1 pcs: Lin Mtrs 1,0 (h1,40)

COM fabric min. order
10pcs each code
Tessuto cliente TC ordine
min. 10pz per codice

Min. order 4pcs
each code
Ordine min 4pz
per codice

**COLORFIVE
WRAP ST
UPHOLSTERED**



Techno-polymer upholstered shell, chromed or painted metal frame.
Scocca in tecnopolimero rivestita, telaio in metallo cromato o verniciato.

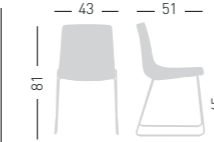

NA not assembled / non assemblato



Frame Finishing & Codes / Finiture Telai e Codici

cod.176.--/IEST chromed/cromata	€ 420,00
cod.176.--/IKST chromed/cromata	€ 420,00
cod.176.--/IBST chromed/cromata	€ 444,00
cod.176./ITCST chromed/cromata	€ 370,00
cod.176.--/IESTB white painted/verniciato bianco	€ 456,00
cod.176.--/IKSTB white painted/verniciato bianco	€ 456,00
cod.176.--/IBSTB white painted/verniciato bianco	€ 480,00
cod.176./ITCSTB white painted/verniciato bianco	€ 400,00
cod.176.--/IESTN black painted/verniciato nero	€ 456,00
cod.176.--/IKSTN black painted/verniciato nero	€ 456,00
cod.176.--/IBSTN black painted/verniciato nero	€ 480,00
cod.176./ITCSTN black painted/verniciato nero	€ 400,00

Fabric required
Fabbisogno di tessuto
1 pcs: Lin Mtrs 1,0 (h1,40)

COM fabric min. order
10pcs each code
Tessuto cliente TC ordine
min. 10pz per codice

Min. order 4pcs
each code
Ordine min 4pz
per codice

**COLORFIVE
WRAP TC
UPHOLSTERED**



Techno-polymer upholstered shell, chromed or painted metal frame.
Scocca in tecnopolimero rivestita, telaio in metallo cromato o verniciato.

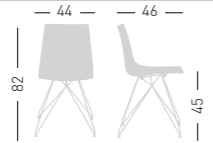

NA not assembled / non assemblato

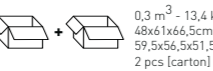

Frame Finishing & Codes / Finiture Telai e Codici

cod.176.--/IETC chromed/cromata	€ 424,00
cod.176.--/IKTC chromed/cromata	€ 424,00
cod.176.--/IBTC chromed/cromata	€ 448,00
cod.176./ITCTC chromed/cromata	€ 372,00
cod.176.--/IETCB white painted/verniciato bianco	€ 452,00
cod.176.--/IKTCB white painted/verniciato bianco	€ 452,00
cod.176.--/IBTCB white painted/verniciato bianco	€ 476,00
cod.176./ITCTCB white painted/verniciato bianco	€ 400,00
cod.176.--/IETCN black painted/verniciato nero	€ 452,00
cod.176.--/IKTCN black painted/verniciato nero	€ 452,00
cod.176.--/IBTCN black painted/verniciato nero	€ 476,00
cod.176./ITCTCN black painted/verniciato nero	€ 400,00

Fabric required
Fabbisogno di tessuto
1 pcs: Lin Mtrs 1,0 (h1,40)

COM fabric min. order
10pcs each code
Tessuto cliente TC ordine
min. 10pz per codice

Min. order 4pcs
each code
Ordine min 4pz
per codice

**COLORFIVE
WRAP 5R
UPHOLSTERED**



Techno-polymer upholstered shell, polished aluminum base with castors.
Scocca in tecnopolimero rivestita, base in alluminio pulito con ruote.

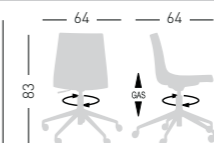

NA not assembled / non assemblato



Frame Finishing & Codes / Finiture Telai e Codici

cod.176.--/IESR polished/lucida	€ 594,00
cod.176.--/IKSR polished/lucida	€ 594,00
cod.176.--/IBSR polished/lucida	€ 618,00
cod.176./ITC5R polished/lucida	€ 542,00

Fabric required
Fabbisogno di tessuto
1 pcs: Lin Mtrs 1,0 (h1,40)

COM fabric min. order
10pcs each code
Tessuto cliente TC ordine
min. 10pz per codice

Min. order 4pcs
each code
Ordine min 4pz
per codice

**COLORFIVE
WRAP TP
UPHOLSTERED**



Techno-polymer upholstered shell, techno-polymer painted frame.
Scocca in tecnopolimero rivestita, telaio in tecnopolimero verniciato.

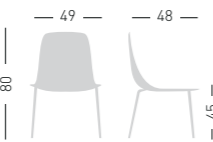

stackable / impilabile (4pcs)

NA not assembled / non assemblato



Frame Finishing & Codes / Finiture Telai e Codici

cod.176.--/IETPB white painted/verniciato bianco	€ 462,00
cod.176.--/IKTPB white painted/verniciato bianco	€ 462,00
cod.176.--/IBTPB white painted/verniciato bianco	€ 486,00
cod.176./ITCTPB white painted/verniciato bianco	€ 412,00

Fabric required
Fabbisogno di tessuto
1 pcs: Lin Mtrs 1,0 (h1,40)

COM fabric min. order
10pcs each code
Tessuto cliente TC ordine
min. 10pz per codice

Min. order 4pcs
each code
Ordine min 4pz
per codice

**COLORFIVE
WRAP L
UPHOLSTERED**



Techno-polymer upholstered shell, polished aluminum base.
Scocca in tecnopolimero rivestita, base in alluminio pulito.

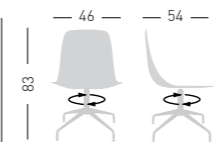

NA not assembled / non assemblato

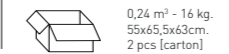

Frame Finishing & Codes / Finiture Telai e Codici

cod.176.--/IEL polished/lucida	€ 594,00
cod.176.--/IKL polished/lucida	€ 594,00
cod.176.--/IBL polished/lucida	€ 618,00
cod.176./ITCL polished/lucida	€ 542,00

Felt Glides / Tappi in feltro

Fabric required
Fabbisogno di tessuto
1 pcs: Lin Mtrs 1,0 (h1,40)

COM fabric min. order
10pcs each code
Tessuto cliente TC ordine
min. 10pz per codice

Min. order 4pcs
each code
Ordine min 4pz
per codice

**COLORFIVE
WRAP S
UPHOLSTERED**



Techno-polymer upholstered shell, chromed or painted metal frame.
Scocca in tecnopolimero rivestita, telaio in metallo cromato o verniciato

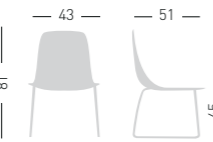

NA not assembled / non assemblato

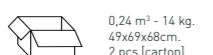

Frame Finishing & Codes / Finiture Telai e Codici

cod.176.--/IES chromed/cromata	€ 408,00
cod.176.--/IKS chromed/cromata	€ 408,00
cod.176.--/IBS chromed/cromata	€ 432,00
cod.176./ITCS chromed/cromata	€ 356,00
cod.176.--/IESB white painted/verniciato bianco	€ 438,00
cod.176.--/IKSB white painted/verniciato bianco	€ 438,00
cod.176.--/IBSB white painted/verniciato bianco	€ 462,00
cod.176./ITCSB white painted/verniciato bianco	€ 388,00
cod.176.--/IESN black painted/verniciato nero	€ 438,00
cod.176.--/IKSN black painted/verniciato nero	€ 438,00
cod.176.--/IBSN black painted/verniciato nero	€ 462,00
cod.176./ITCSN black painted/verniciato nero	€ 388,00

Fabric required
Fabbisogno di tessuto
1 pcs: Lin Mtrs 1,0 (h1,40)

COM fabric min. order
10pcs each code
Tessuto cliente TC ordine
min. 10pz per codice

Min. order 4pcs
each code
Ordine min 4pz
per codice



Available colors / Colori disponibili



IGN Versions follows UNI 9177 certification in terms of Fire Resistance, Fire Reaction Class 2
Versioni IGN prodotto Omologato con Classe di Reazione al fuoco 2, UNI 9177



COMPACT



Aluminum and techno-polymer folding chair.
Seduta pieghevole con struttura in alluminio e tecnopolimero.

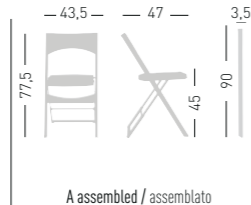

A assembled / assemblato



0,02 m³ - 4,5 kg.
43x91x4,5cm.
1 pcs (carton)

Frame Finishing & Codes / Finiture Telai e Codici

cod.29.--/A

€ 158,00

cod.29.--/IGN fire retardant / ignifuga

€ 216,00

fire retardant minimum 300 pcs
ignifuga minimo 300 pz

COMPACT TROLLEY/CARRELLO

Trolley for Compact chair 7 pieces / Carrello sedia Compact 7 pezzi cod. 2006/A
Trolley for Compact chair 14 pieces / Carrello sedia Compact 14 pezzi cod. 2007/A



A assembled / assemblato



0,30 m³ - 9 kg.
62,5x44x97cm.
2 pcs (carton)



0,55 m³ - 9 kg.
120x44x97cm.
1 pcs (carton)

COMPACT WALL HOOK/GANCIO A MURO

Wall hook 2 fold. chairs / Gancio a muro per 2 sedie pieghevoli cod. 1060
Wall hook 4 fold. chairs / Gancio a muro per 4 sedie pieghevoli cod. 1061



A assembled / assemblato



0,02 m³ - 1 kg.
26x13x4,5cm.
1 pcs (carton)

cod.2006/A
cod.2007/A
cod.1060
cod.1061

€ 234,00
€ 364,00
€ 76,00
€ 82,00

COMPACT UNDERSEAT COVER COPERTINA SOTTOSEDILE



Compact under seat cover, to be assembled, black color.
Copertina sotto sedile Compact, da assemblare, colore nero.



0,02 m³ - 5 kg.
40x40x10cm.
10 pcs (carton)

NA not assembled / non assemblato

Frame Finishing & Codes / Finiture Telai e Codici

cod.333.10 black / nera

€ 16,00

Other colors minimum order 300pcs x color
Altri colori ordine minimo 300pz per colore



Frame / Struttura telaio



Compact Color / Colore Piano Compact



Suitable for outdoor purpose with GR-SX-MG finishes
Adatto all'uso per esterno con finiture GR-SX-MG

BASE AND SEAT KIT



Basement with all necessary legs, caps, screws and upholstered cushion, Quick Dry Foam.
Basamento con tutti i necessari piedini, tappi e viti, sedile tappezzato e schiuma Quick Dry.



NA not assembled / non assemblato



0,1 m³ - 6,1 kg.
55x55x31cm.
1 pcs (carton)

Frame Finishing & Codes / Finiture Telai e Codici

cod. 214._/IGTP_
cod. 214._/IKTP_
cod. 214._/ISXTP_
cod. 214._/IETP_
cod. 214._/IMGTP_
cod. 214._/IDKTP_
cod. 214._/ITCTP_

€ 286,00
€ 310,00
€ 314,00
€ 310,00
€ 314,00
€ 454,00
€ 268,00

Fabric required
Fabbisogno di tessuto
1 pcs: Lin Mtrs 1,0 (h1,40)

COM fabric min. order
10pcs each code
Tessuto cliente TC ordine
min. 10pz per codice

BACKREST/ SCHIENALE



Backrest support with upholstered cushion, Quick Dry Foam.
Supporto Schienale con Cuscino tappez., schiuma Quick Dry.

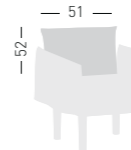

NA not assembled / non assemblato



0,07 m³ - 2,5 kg.
61x60x20cm.
1 pcs (carton)

Frame Finishing & Codes / Finiture Telai e Codici

cod. 210._(GR)
cod. 210._(K)
cod. 210._(SX)
cod. 210._(E)
cod. 210._(MG)
cod. 210._(DK)
cod. 210._(TC)

€ 166,00
€ 182,00
€ 190,00
€ 182,00
€ 190,00
€ 300,00
€ 148,00

Fabric required
Fabbisogno di tessuto
1 pcs: Lin Mtrs 1,0 (h1,40)

COM fabric min. order
10pcs each code
Tessuto cliente TC ordine
min. 10pz per codice

**SINGLE ARMREST/
BRACCIOLO
SINGOLO**



Armrest support with upholstered cushion, Quick Dry Foam.
Supporto Bracciolo con Cuscino tappez., schiuma Quick Dry.

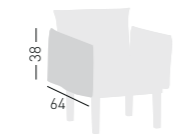

NA not assembled / non assemblato



0,06 m³ - 2 kg.
66x43x20cm.
1 pcs (carton)

Frame Finishing & Codes / Finiture Telai e Codici

cod. 212.__(GR)
cod. 212.__(K)
cod. 212.__(SX)
cod. 212.__(E)
cod. 212.__(MG)
cod. 212.__(DK)
cod. 212.__(TC)

€ 138,00
€ 152,00
€ 160,00
€ 152,00
€ 160,00
€ 254,00
€ 124,00

Fabric required
Fabbisogno di tessuto
1 pcs: Lin Mtrs 1,0 (h1,40)

COM fabric min. order
10pcs each code
Tessuto cliente TC ordine
min. 10pz per codice

TABLE/TAVOLINO



Table, with Compactop.
Tavolino con Compactop.

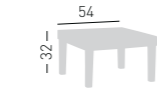

NA not assembled / non assemblato



0,1 m³ - 8 kg.
60x60x30cm.
1 pcs (carton)

Frame Finishing & Codes / Finiture Telai e Codici

cod. TCONC028.__(H)32

€ 280,00

EXAMPLES / ESEMPI:

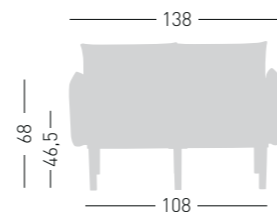
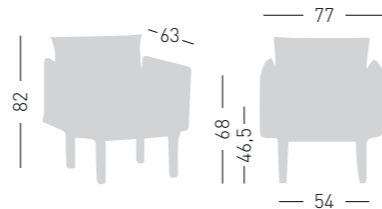

Cucaracha



Products follows UNI 9175 -UNI 9175/FA, in terms of Fire Resistance, Fire Reation Class 1M
Prodotto Omologato dal Ministero dell'Interno, secondo la UNI 9175 -UNI 9175/FA, con classe di Reazione al fuoco 1M



Available fabric / Tessuti disponibili
King fabric / Tessuto King **K** (2pcs min.)
Blazer fabric / Tessuto Blazer **B** (2pcs min.)
Kvadrat fabrics / Tessuti Kvadrat **DK** (2pcs min.)
COM fabric / Tessuto cliente **TC** (10pcs min.)

CUCARACHA LB



Swivel in 4-blade black painted aluminum base, tilt mechanism, upholstered low back shell.
Girevole su basamento 4 razze in alluminio nero, meccanismo oscillante, scocca schienale basso rivestita.

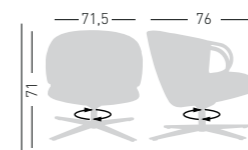

NA not assembled / non assemblato



0,71 m³ - 29 kg.
80x90x95cm.
1 pc (carton)

Frame Finishing & Codes / Finiture Telai e Codici

cod.395.__(IBLN)
cod.395.__(IKLN)
cod.395.__(IDKLN)
cod.395.__(ITCLN)

€ 1.790,00
€ 1.646,00
€ 1.936,00
€ 1.476,00

Fabric required
Fabbisogno di tessuto
1 pcs: Lin Mtrs 1,8 (h1,40)

COM fabric min. order
10pcs each code
Tessuto cliente TC ordine
min. 10pz per codice

Min. order 2pcs
each code
Ordine min 2pz
per codice

CUCARACHA HB



Swivel in 4-blade black painted aluminum base, tilt mechanism, upholstered high back shell.
Girevole su basamento 4 razze in alluminio nero, meccanismo oscillante, scocca schienale alto rivestita.

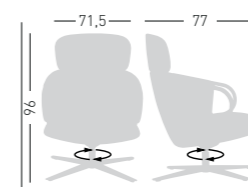

NA not assembled / non assemblato



0,71 m³ - 31 kg.
80x90x95cm.
1 pc (carton)

Frame Finishing & Codes / Finiture Telai e Codici

cod.394.__(IBLN)
cod.394.__(IKLN)
cod.394.__(IDKLN)
cod.394.__(ITCLN)

€ 1.952,00
€ 1.806,00
€ 2.096,00
€ 1.734,00

Twin color upholstery details available on request
Dettagli tappezzeria bi-colore disponibili su richiesta

Fabric required
Fabbisogno di tessuto
1 pcs: Lin Mtrs 1,8 (h1,40)

COM fabric min. order
10pcs each code
Tessuto cliente TC ordine
min. 10pz per codice

Min. order 2pcs
each code
Ordine min 2pz
per codice

CUCARACHA LB BL

Upholstered PU-Flex low back Shell, 4-legged beech wooden frame. Scocca schienale basso in PU-Flex rivestita, struttura in legno di faggio 4 gambe.

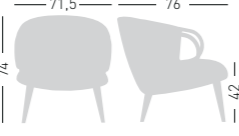
71,5 76
74 42

NA not assembled / non assemblato



0,71 m³ - 29 kg.
80x90x95cm.
1 pc (carton)

Frame Finishing & Codes / Finiture Telai e Codici

cod.395._/IBBL_ € **1.834,00**
cod.395._/IKBL_ € **1.690,00**
cod.395._/IDKBL_ € **1.980,00**
cod.395._/ITCBL_ € **1.520,00**

Felt Glides / Tappi in feltro

Fabric required
Fabbisogno di tessuto
1 pcs: Lin Mtrs 1,8 (h1,40)

COM fabric min. order 10pcs each code
Tessuto cliente TC ordine min. 10pz per codice



Min. order 2pcs each code
Ordine min 2pz per codice

Price + € 20,00



CUCARACHA HB BL

Upholstered High Back PU-Flex Shell, 4-legged beech wooden frame. Scocca schienale alto in PU-Flex rivestita, struttura in legno di faggio 4 gambe.

71,5 77
99 42

NA not assembled / non assemblato



0,71 m³ - 31 kg.
80x90x95cm.
1 pc (carton)

Frame Finishing & Codes / Finiture Telai e Codici

cod.394._/IBBL_ € **1.996,00**
cod.394._/IKBL_ € **1.850,00**
cod.394._/IDKBL_ € **2.140,00**
cod.394._/ITCBL_ € **1.778,00**

Felt Glides / Tappi in feltro

Twin color upholstery details available on request
Dettagli tappezzeria bi-colore disponibili su richiesta

Fabric required
Fabbisogno di tessuto
1 pcs: Lin Mtrs 1,8 (h1,40)

COM fabric min. order 10pcs each code
Tessuto cliente TC ordine min. 10pz per codice

Min. order 2pcs each code
Ordine min 2pz per codice

Price + € 20,00



CUCARACHA TABLET / TAVOLETTA

Swivel and 360° rotating compactop tablet. Tavolettina in Compactop girevole e rotante a 360°.



NA not assembled / non assemblato



0,25 m³ - 9 kg.
60x54x76cm.
1 pc (carton)

Frame Finishing & Codes / Finiture Telai e Codici

cod.1210.10 € **630,00**

Available for model:
Cucaracha LB - Cucaracha HB
Disponibile per versioni:
Cucaracha LB - Cucaracha HB



Products follows UNI 9175 -UNI 9175/FA, in terms of Fire Resistance, Fire Reation Class 11M
Prodotto Omologato dal Ministero dell'Interno , secondo la UNI 9175 -UNI 9175/FA, con classe di Reazione al fuoco 11M



Available fabric / Tessuti disponibili
King fabric / Tessuto King **K** (4pcs min.)
Blazer fabric / Tessuto Blazer **B** (4pcs min.)
Kvadrat fabrics / Tessuti Kvadrat **DK** (4pcs min.)
COM fabric / Tessuto cliente **TC** (10pcs min.)

CUCARACHA SLIM BL

Upholstered PU-Flex Shell, 4-legged beech wooden frame. Scocca in PU-Flex rivestita, struttura in legno di faggio 4 gambe.

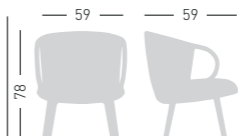
59 59
78 46

A assembled / assemblato



0,30 m³ - 13 kg.
60x54x92cm.
1 pc (carton)

Frame Finishing & Codes / Finiture Telai e Codici

cod.393._/IBBL_ € **1.106,00**
cod.393._/IKBL_ € **974,00**
cod.393._/IDKBL_ € **1.280,00**
cod.393./ITCBL_ € **872,00**

Felt Glides / Tappi in feltro

Fabric required
Fabbisogno di tessuto
1 pcs: Lin Mtrs 1,4 (h1,40)

COM fabric min. order 10pcs each code
Tessuto cliente TC ordine min. 10pz per codice



Min. order 4pcs each code
Ordine min 4pz per codice

Price + € 20,00



CUCARACHA SLIM U

Upholstered PU-Flex Shell, swivel on 4-blade painted or polished aluminum base. Tilt mechanism. Scocca un PU-Flex rivestita, girevole su basamento verniciato o lucido in alluminio 4 razze. Meccanismo oscillante.

72 72
78 46

NA not assembled / non assemblato



0,30 m³ - 14 kg.
60x54x92cm.
1 pc (carton)

Frame Finishing & Codes / Finiture Telai e Codici

cod.393._/IBUN black/nera € **1.136,00**
cod.393._/IKUN black/nera € **1.002,00**
cod.393._/IDKUN black/nera € **1.306,00**
cod.393./ITCUN black/nera € **904,00**
cod.393._/IBUL polished/lucida € **1.162,00**
cod.393._/IKUL polished/lucida € **1.030,00**
cod.393._/IDKUL polished/lucida € **1.334,00**
cod.393./ITCUL polished/lucida € **848,00**

Felt Glides / Tappi in feltro

Fabric required
Fabbisogno di tessuto
1 pcs: Lin Mtrs 1,4 (h1,40)

COM fabric min. order 10pcs each code
Tessuto cliente TC ordine min. 10pz per codice

Min. order 4pcs each code
Ordine min 4pz per codice

Dame



Available Shell Color / Colori disponibili Scocca

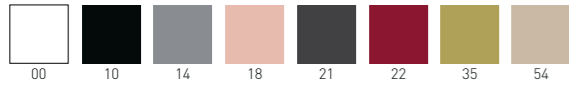

DAME NA



Chromed or painted 4-Legged metal frame, techno-polymer shell and upholstered cushion.

Struttura in metallo 4 gambe, cromata o verniciata, scocca in tecnopolimero con cuscino tappezzato.

Unless otherwise specified, frame and shell colors are combined.

Se non diversamente specificato, i colori della struttura e della scocca sono abbinati.

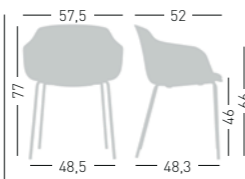

NA not assembled / non assemblata

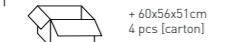

Available Painted Frame Colors / Colori disponibili Telaio Verniciato

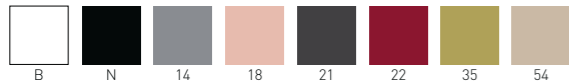

Suitable for outdoor purpose with SX-E-MG finishes
Adatto all'uso per esterni con finiture SX-E-MG

Frame Finishing & Codes / Finiture Telai e Codici

cod. 266. __ _ (K) / NA chromed/cromata	€ 412,00
cod. 266. __ _ (B) / NA chromed/cromata	€ 426,00
cod. 266. __ _ (S) / NA chromed/cromata	€ 426,00
cod. 266. __ _ (DK) / NA chromed/cromata	€ 436,00
cod. 266. __ _ (SX) / NA chromed/cromata	€ 416,00
cod. 266. __ _ (E) / NA chromed/cromata	€ 412,00
cod. 266. __ _ (MG) / NA chromed/cromata	€ 416,00
cod. 266. __ _ TC / NA chromed/cromata	€ 396,00

cod. 266. __ _ (K) / NA painted/verniciato	€ 444,00
cod. 266. __ _ (B) / NA painted/verniciato	€ 460,00
cod. 266. __ _ (S) / NA painted/verniciato	€ 460,00
cod. 266. __ _ (DK) / NA painted/verniciato	€ 468,00
cod. 266. __ _ (SX) / NA painted/verniciato	€ 452,00
cod. 266. __ _ (E) / NA painted/verniciato	€ 452,00
cod. 266. __ _ (MG) / NA painted/verniciato	€ 452,00
cod. 266. __ _ TC / NA painted/verniciato	€ 432,00

Fabric required
Fabbisogno di tessuto
4 pcs: Lin Mtrs 1,0 (h1,40)

COM fabric min. order
10pcs each code
Tessuto cliente TC ordine
min. 10pz per codice

Min. order 4pcs
each code
Ordine min 4pz
per codice

DAME BP



4 polymer-steel co-injected legs structure, techno-polymer shell and upholstered cushion.

Struttura 4 gambe in co-iniezione metallo-polimero, scocca in tecnopolimero e cuscino tappezzato.

Unless otherwise specified, frame and shell colors are combined.

Se non diversamente specificato, i colori della struttura e della scocca sono abbinati.

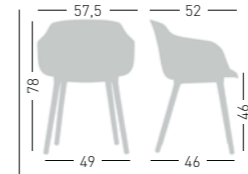

NA not assembled / non assemblata



Available Legs Color / Colori disponibili Gambe

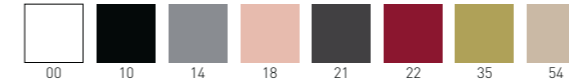

Suitable for outdoor purpose with SX-E-MG finishes
Adatto all'uso per esterni con finiture SX-E-MG

Frame Finishing & Codes / Finiture Telai e Codici

cod. 266. __ _ (K) / BP	€ 540,00
cod. 266. __ _ (B) / BP	€ 554,00
cod. 266. __ _ (S) / BP	€ 554,00
cod. 266. __ _ (DK) / BP	€ 564,00
cod. 266. __ _ (SX) / BP	€ 540,00
cod. 266. __ _ (E) / BP	€ 544,00
cod. 266. __ _ (MG) / BP	€ 544,00
cod. 266. __ _ TC / BP	€ 526,00

Fabric required
Fabbisogno di tessuto
4 pcs: Lin Mtrs 1,0 (h1,40)

COM fabric min. order
10pcs each code
Tessuto cliente TC ordine
min. 10pz per codice

Min. order 4pcs
each code
Ordine min 4pz
per codice

DAME CTL



Chromed or Painted cantilevered metal frame, techno-polymer shell and upholstered cushion.

Struttura in metallo cantilever, cromata o verniciata, scocca in tecnopolimero e cuscino tappezzato.

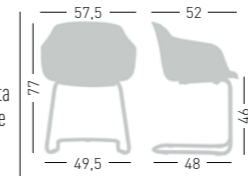

NA not assembled / non assemblata



Frame Finishing & Codes / Finiture Telai e Codici

cod. 266. __ _ (K) / CTL chromed/cromata	€ 438,00
cod. 266. __ _ (B) / CTL chromed/cromata	€ 454,00
cod. 266. __ _ (S) / CTL chromed/cromata	€ 454,00
cod. 266. __ _ (DK) / CTL chromed/cromata	€ 462,00
cod. 266. __ _ (SX) / CTL chromed/cromata	€ 442,00
cod. 266. __ _ (E) / CTL chromed/cromata	€ 438,00
cod. 266. __ _ (MG) / CTL chromed/cromata	€ 442,00
cod. 266. __ _ TC / CTL chromed/cromata	€ 422,00

cod. 266. __ _ (K) / CTLN black painted/verniciato nero	€ 462,00
cod. 266. __ _ (B) / CTLN black painted/verniciato nero	€ 478,00
cod. 266. __ _ (S) / CTLN black painted/verniciato nero	€ 478,00
cod. 266. __ _ (DK) / CTLN black painted/verniciato nero	€ 486,00
cod. 266. __ _ (SX) / CTLN black painted/verniciato nero	€ 466,00
cod. 266. __ _ (E) / CTLN black painted/verniciato nero	€ 462,00
cod. 266. __ _ (MG) / CTLN black painted/verniciato nero	€ 466,00
cod. 266. __ _ TC / CTLN black painted/verniciato nero	€ 446,00

Fabric required
Fabbisogno di tessuto
4 pcs: Lin Mtrs 1,0 (h1,40)

COM fabric min. order
10pcs each code
Tessuto cliente TC ordine
min. 10pz per codice

Min. order 4pcs
each code
Ordine min 4pz
per codice

DAME ST



Chromed or painted sled steel frame, techno-polymer shell and upholstered cushion.

Struttura a slitta, cromata o verniciata, scocca in tecnopolimero e cuscino tappezzato.

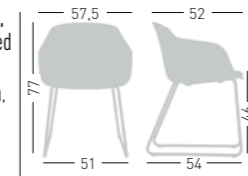

NA not assembled / non assemblata



Frame Finishing & Codes / Finiture Telai e Codici

cod. 266. __ _ (K) / ST chromed/cromata	€ 432,00
cod. 266. __ _ (B) / ST chromed/cromata	€ 444,00
cod. 266. __ _ (S) / ST chromed/cromata	€ 444,00
cod. 266. __ _ (DK) / ST chromed/cromata	€ 456,00
cod. 266. __ _ (SX) / ST chromed/cromata	€ 436,00
cod. 266. __ _ (E) / ST chromed/cromata	€ 432,00
cod. 266. __ _ (MG) / ST chromed/cromata	€ 436,00
cod. 266. __ _ TC / ST chromed/cromata	€ 416,00

cod. 266. __ _ (K) / STN black painted/verniciato nero	€ 454,00
cod. 266. __ _ (B) / STN black painted/verniciato nero	€ 466,00
cod. 266. __ _ (S) / STN black painted/verniciato nero	€ 466,00
cod. 266. __ _ (DK) / STN black painted/verniciato nero	€ 478,00
cod. 266. __ _ (SX) / STN black painted/verniciato nero	€ 478,00
cod. 266. __ _ (E) / STN black painted/verniciato nero	€ 454,00
cod. 266. __ _ (MG) / STN black painted/verniciato nero	€ 458,00
cod. 266. __ _ TC / STN black painted/verniciato nero	€ 438,00

Fabric required
Fabbisogno di tessuto
4 pcs: Lin Mtrs 1,0 (h1,40)

COM fabric min. order
10pcs each code
Tessuto cliente TC ordine
min. 10pz per codice

Min. order 4pcs
each code
Ordine min 4pz
per codice

DAME PL



4-legged wooden swivel base with solid Oak spokes reinforced with inner steel structure, techno-polymer shell and upholstered cushion.
Base girevole con quattro razze in rovere rinforzate con struttura in acciaio interna, scocca in tecnopolimero e cuscino tappezzato.

CATAS
TESTATO - TESTED

Oak Essence / Essenza Rovere

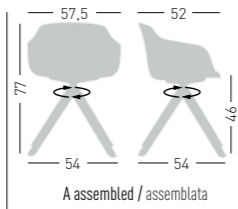

A assembled / assemblata

0,30 m³ - 9 kg.
54x60x92 cm.
1 pcs [carton]

Frame Finishing & Codes / Finiture Telai e Codici

cod. 266.__(K)/PLRN Oak/Rovere	€ 662,00
cod. 266.__(B)/PLRN Oak/Rovere	€ 678,00
cod. 266.__(S)/PLRN Oak/Rovere	€ 678,00
cod. 266.__(DK)/PLRN Oak/Rovere	€ 686,00
cod. 266.__(SX)/PLRN Oak/Rovere	€ 844,00
cod. 266.__(E)/PLRN Oak/Rovere	€ 662,00
cod. 266.__(MG)/PLRN Oak/Rovere	€ 668,00
cod. 266.__(TC)/PLRN Oak/Rovere	€ 650,00

Fabric required
Fabbisogno di tessuto
4 pcs: Lin Mtrs 1,0 (h1,40)

COM fabric min. order
10pcs each code
Tessuto cliente TC ordine
min. 10pz per codice

Min. order 4pcs
each code
Ordine min 4pz
per codice

DAME BL



4-Legged wooden beach frame, techno-polymer shell and upholstered cushion.
Struttura in legno di faggio 4 gambe, scocca in tecnopolimero e cuscino tappezzato.

Price + € 20,00

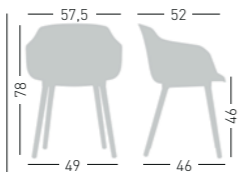

NA not assembled / non assemblata

0,48 m³ - 31 kg.
62x57x42cm

+ 60x56x51cm
4 pcs [carton]

Frame Finishing & Codes / Finiture Telai e Codici

cod. 266.__(K)/BL	€ 576,00
cod. 266.__(B)/BL	€ 590,00
cod. 266.__(S)/BL	€ 590,00
cod. 266.__(DK)/BL	€ 600,00
cod. 266.__(SX)/BL	€ 580,00
cod. 266.__(E)/BL	€ 576,00
cod. 266.__(MG)/BL	€ 580,00
cod. 266.__(TC)/BL	€ 562,00

Felt Glides / Tappi in feltro

Fabric required
Fabbisogno di tessuto
4 pcs: Lin Mtrs 1,0 (h1,40)

COM fabric min. order
10pcs each code
Tessuto cliente TC ordine
min. 10pz per codice

Min. order 4pcs
each code
Ordine min 4pz
per codice

DAME U



Swivel on 4-blade aluminum painted base, with glides, techno-polymer shell and upholstered cushion.
Girevole su basamento verniciato a 4 razze su piedini, scocca in tecnopolimero e cuscino tappezzato.

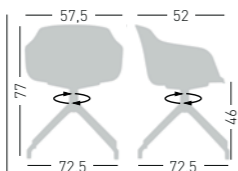

NA not assembled / non assemblata

0,33 m³ - 15 kg.
62x57x42cm

+ 60x56x51cm
2 pcs [carton]

Frame Finishing & Codes / Finiture Telai e Codici

cod. 266.__(K)/UB white painted/verniciato bianco	€ 596,00
cod. 266.__(B)/UB white painted/verniciato bianco	€ 610,00
cod. 266.__(S)/UB white painted/verniciato bianco	€ 610,00
cod. 266.__(DK)/UB white painted/verniciato bianco	€ 620,00
cod. 266.__(SX)/UB white painted/verniciato bianco	€ 600,00
cod. 266.__(E)/UB white painted/verniciato bianco	€ 596,00
cod. 266.__(MG)/UB white painted/verniciato bianco	€ 600,00
cod. 266.__(TC)/UB white painted/verniciato bianco	€ 580,00

cod. 266.__(K)/UN black painted/verniciato nero	€ 596,00
cod. 266.__(B)/UN black painted/verniciato nero	€ 610,00
cod. 266.__(S)/UN black painted/verniciato nero	€ 610,00
cod. 266.__(DK)/UN black painted/verniciato nero	€ 620,00
cod. 266.__(SX)/UN black painted/verniciato nero	€ 600,00
cod. 266.__(E)/UN black painted/verniciato nero	€ 596,00
cod. 266.__(MG)/UN black painted/verniciato nero	€ 600,00
cod. 266.__(TC)/UN black painted/verniciato nero	€ 580,00

Felt Glides / Tappi in feltro

Fabric required
Fabbisogno di tessuto
4 pcs: Lin Mtrs 1,0 (h1,40)

COM fabric min. order
10pcs each code
Tessuto cliente TC ordine
min. 10pz per codice

Min. order 4pcs
each code
Ordine min 4pz
per codice

DAME UR



Swivel on 4-blade aluminum painted base, with castors, techno-polymer shell and upholstered cushion.
Girevole su basamento verniciato in alluminio 4 razze su ruote, scocca in tecnopolimero e cuscino tappezzato.

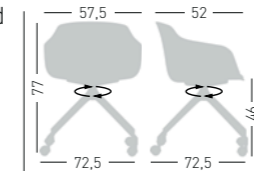

NA not assembled / non assemblata

0,30 m³ - 15,2 kg.
62x57x42cm
+ 62x57x42cm
2 pcs [carton]

Frame Finishing & Codes / Finiture Telai e Codici

cod. 266.__(K)/URB white painted/verniciato bianco	€ 622,00
cod. 266.__(B)/URB white painted/verniciato bianco	€ 636,00
cod. 266.__(S)/URB white painted/verniciato bianco	€ 636,00
cod. 266.__(DK)/URB white painted/verniciato bianco	€ 646,00
cod. 266.__(SX)/URB white painted/verniciato bianco	€ 628,00
cod. 266.__(E)/URB white painted/verniciato bianco	€ 622,00
cod. 266.__(MG)/URB white painted/verniciato bianco	€ 628,00
cod. 266.__(TC)/URB white painted/verniciato bianco	€ 608,00

cod. 266.__(K)/URN black painted/verniciato nero	€ 622,00
cod. 266.__(B)/URN black painted/verniciato nero	€ 636,00
cod. 266.__(S)/URN black painted/verniciato nero	€ 636,00
cod. 266.__(DK)/URN black painted/verniciato nero	€ 646,00
cod. 266.__(SX)/URN black painted/verniciato nero	€ 628,00
cod. 266.__(E)/URN black painted/verniciato nero	€ 622,00
cod. 266.__(MG)/URN black painted/verniciato nero	€ 628,00
cod. 266.__(TC)/URN black painted/verniciato nero	€ 608,00

Fabric required
Fabbisogno di tessuto
4 pcs: Lin Mtrs 1,0 (h1,40)

COM fabric min. order
10pcs each code
Tessuto cliente TC ordine
min. 10pz per codice

Min. order 4pcs
each code
Ordine min 4pz
per codice

DAME R



Swivel on chromed base, techno-polymer shell and upholstered cushion.
Girevole su basamento in acciaio cromato, scocca in tecnopolimero e cuscino tappezzato.

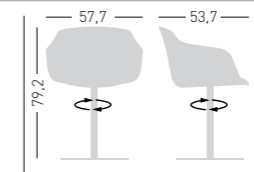

NA not assembled / non assemblata

0,14 m³ - 15,5 kg.
61x56x41,5cm
1 pc [carton]

Frame Finishing & Codes / Finiture Telai e Codici

cod. 266.__(K)/R chromed base/base cromata	€ 600,00
cod. 266.__(B)/R chromed base/base cromata	€ 614,00
cod. 266.__(S)/R chromed base/base cromata	€ 614,00
cod. 266.__(DK)/R chromed base/base cromata	€ 622,00
cod. 266.__(SX)/R chromed base/base cromata	€ 606,00
cod. 266.__(E)/R chromed base/base cromata	€ 600,00
cod. 266.__(MG)/R chromed base/base cromata	€ 606,00
cod. 266.__(TC)/R chromed base/base cromata	€ 588,00

Fabric required
Fabbisogno di tessuto
4 pcs: Lin Mtrs 1,0 (h1,40)

COM fabric min. order
10pcs each code
Tessuto cliente TC ordine
min. 10pz per codice

Min. order 4pcs
each code
Ordine min 4pz
per codice

DAME UPHOLSTERED IMBOTTITE

DRESS DAME NA

Chromed or painted 4-Legged metal frame, padded and upholstered shell.
Struttura in metallo 4 gambe, cromata o verniciata, scocca imbottita e rivestita.

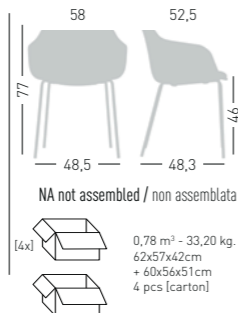

Frame Finishing & Codes / Finiture Telaie e Codici

cod. 266. __/IKNA chromed/cromata	€ 706,00
cod. 266. __/IBNA chromed/cromata	€ 770,00
cod. 266. __/ISNA chromed/cromata	€ 770,00
cod. 266. __/IDKNA chromed/cromata	€ 900,00
cod. 266. __/IENA chromed/cromata	€ 706,00
cod. 266. __/IPNA chromed/cromata	€ 900,00
cod. 266./ITCNA chromed/cromata	€ 654,00

cod. 266. __/IKNA__ painted/verniciato	€ 742,00
cod. 266. __/IBNA__ painted/verniciato	€ 804,00
cod. 266. __/ISNA__ painted/verniciato	€ 804,00
cod. 266. __/IDKNA__ painted/verniciato	€ 964,00
cod. 266. __/IENA__ painted/verniciato	€ 742,00
cod. 266. __/IPNA__ painted/verniciato	€ 964,00
cod. 266./ITCNA__ painted/verniciato	€ 702,00

Fabric required
Fabbisogno di tessuto
1 pc: Lin Mtrs 1,8 (h1,40)

COM fabric min. order
10pcs each code
Tessuto cliente TC ordine
min. 10pz per codice

Min. order 4pcs
each code
Ordine min 4pz
per codice

Available Painted Frame Colors / Colori disponibili Telaio Verniciato

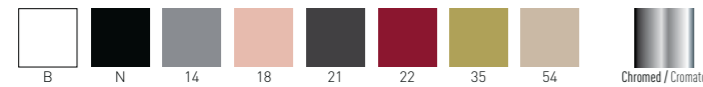

DRESS DAME BP

4 polymer-steel co-injected legs structure, padded and upholstered shell.
Struttura 4 gambe in co-iniezione metallo-polimero, scocca imbottita e rivestita.

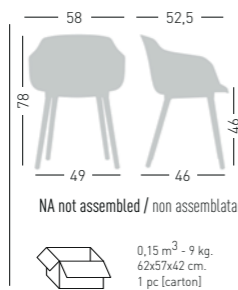

Frame Finishing & Codes / Finiture Telaie e Codici

cod. 266. __/IKBP__	€ 834,00
cod. 266. __/IBBP__	€ 898,00
cod. 266. __/ISBP__	€ 898,00
cod. 266. __/IDKBP__	€ 994,00
cod. 266. __/IEBP__	€ 834,00
cod. 266. __/IPBP__	€ 497,00
cod. 266./ITCBP__	€ 796,00

Fabric required
Fabbisogno di tessuto
1 pc: Lin Mtrs 1,8 (h1,40)

COM fabric min. order
10pcs each code
Tessuto cliente TC ordine
min. 10pz per codice

Min. order 4pcs
each code
Ordine min 4pz
per codice

Available Legs Color / Colori disponibili Gambe

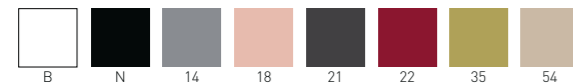

DRESS DAME CTL

Chromed or Painted cantilevered metal frame, padded and upholstered shell.

Struttura in metallo cantilever, cromata o verniciata, scocca imbottita e rivestita.

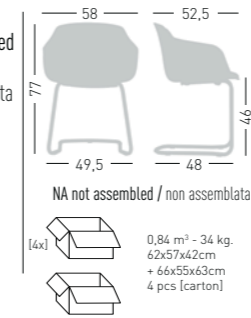

Frame Finishing & Codes / Finiture Telaie e Codici

cod. 266. __/IKCTL chromed/cromata	€ 732,00
cod. 266. __/IBCTL chromed/cromata	€ 796,00
cod. 266. __/ISCTL chromed/cromata	€ 796,00
cod. 266. __/IDKCTL chromed/cromata	€ 894,00
cod. 266. __/IECTL chromed/cromata	€ 732,00
cod. 266. __/IPCTL chromed/cromata	€ 894,00
cod. 266./ITCCTL chromed/cromata	€ 696,00

cod. 266. __/IKCTLN black painted/verniciato nero	€ 768,00
cod. 266. __/IBCTLN black painted/verniciato nero	€ 830,00
cod. 266. __/ISCTLN black painted/verniciato nero	€ 830,00
cod. 266. __/IDKCTLN black painted/verniciato nero	€ 926,00
cod. 266. __/IECTLN black painted/verniciato nero	€ 768,00
cod. 266. __/IPCTLN black painted/verniciato nero	€ 926,00
cod. 266./ITCCTLN black painted/verniciato nero	€ 728,00

Fabric required
Fabbisogno di tessuto
1 pc: Lin Mtrs 1,8 (h1,40)

COM fabric min. order
10pcs each code
Tessuto cliente TC ordine
min. 10pz per codice

Min. order 4pcs
each code
Ordine min 4pz
per codice

DRESS DAME ST

Chromed or painted sled steel frame, padded and upholstered shell.

Struttura a slitta, cromata o verniciata, scocca imbottita e rivestita.

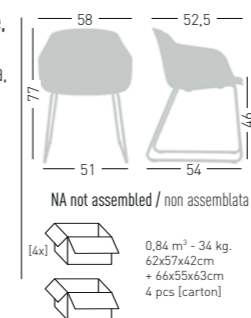

Frame Finishing & Codes / Finiture Telaie e Codici

cod. 266. __/IKST chromed/cromata	€ 726,00
cod. 266. __/IBST chromed/cromata	€ 790,00
cod. 266. __/ISST chromed/cromata	€ 790,00
cod. 266. __/IDKST chromed/cromata	€ 886,00
cod. 266. __/IEST chromed/cromata	€ 726,00
cod. 266. __/IPST chromed/cromata	€ 886,00
cod. 266./ITCST chromed/cromata	€ 686,00

cod. 266. __/IKSTN black painted/verniciato nero	€ 760,00
cod. 266. __/IBSTN black painted/verniciato nero	€ 822,00
cod. 266. __/ISSTN black painted/verniciato nero	€ 822,00
cod. 266. __/IDKSTN black painted/verniciato nero	€ 920,00
cod. 266. __/IESTN black painted/verniciato nero	€ 760,00
cod. 266. __/IPSTN black painted/verniciato nero	€ 920,00
cod. 266./ITCSTN black painted/verniciato nero	€ 722,00

Fabric required
Fabbisogno di tessuto
1 pc: Lin Mtrs 1,8 (h1,40)

COM fabric min. order
10pcs each code
Tessuto cliente TC ordine
min. 10pz per codice

Min. order 4pcs
each code
Ordine min 4pz
per codice

DRESS DAME PL

4-legged wooden swivel base with solid Oak spokes reinforced with inner steel structure, padded and upholstered shell.

Base girevole con quattro razze in rovere rinforzate con struttura in acciaio interna, scocca imbottita e rivestita.

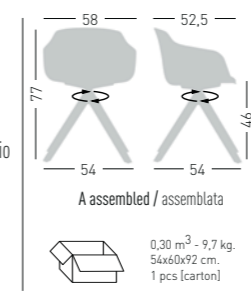

Frame Finishing & Codes / Finiture Telaie e Codici

cod. 266. __/IKPLRN Oak/Rovere	€ 960,00
cod. 266. __/IBPLRN Oak/Rovere	€ 1.020,00
cod. 266. __/ISPLRN Oak/Rovere	€ 1.020,00
cod. 266. __/IDKPLRN Oak/Rovere	€ 1.118,00
cod. 266. __/IEPLRN Oak/Rovere	€ 960,00
cod. 266. __/IPPLRN Oak/Rovere	€ 1.118,00
cod. 266./ITCPLRN Oak/Rovere	€ 904,00

Fabric required
Fabbisogno di tessuto
1 pc: Lin Mtrs 1,8 (h1,40)

COM fabric min. order
10pcs each code
Tessuto cliente TC ordine
min. 10pz per codice

Min. order 4pcs
each code
Ordine min 4pz
per codice

Oak Essence / Essenza Rovere



DRESS DAME BL



4-Legged wooden beach frame, padded and upholstered shell.
Struttura in legno di faggio 4 gambe, scocca imbottita e rivestita.

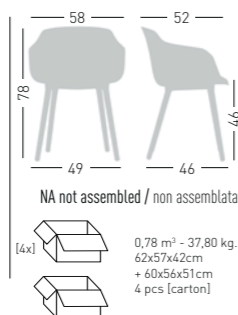

Frame Finishing & Codes / Finiture Telai e Codici

cod. 266. __/IKBL_	€ 872,00
cod. 266. __/IBBL_	€ 936,00
cod. 266. __/ISBL_	€ 936,00
cod. 266. __/IDKBL_	€ 1.032,00
cod. 266. __/IEBL_	€ 872,00
cod. 266. __/IPBL_	€ 1.032,00
cod. 266./ITCBL_	€ 832,00

Felt Glides / Tappi in feltro

Fabric required
Fabbisogno di tessuto
1 pc: Lin Mtrs 1,8 (h1,40)

COM fabric min. order
10pcs each code
Tessuto cliente TC ordine
min. 10pz per codice

Min. order 4pcs
each code
Ordine min 4pz
per codice



DRESS DAME R



Swivel on chromed base, padded and upholstered shell.
Girevole su basamento in acciaio cromato, scocca imbottita e rivestita.

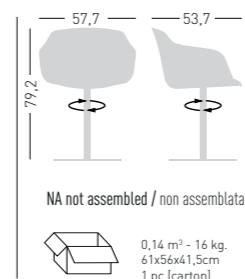

Frame Finishing & Codes / Finiture Telai e Codici

cod. 266. __/IKR chromed base/base cromata	€ 870,00
cod. 266. __/IBR chromed base/base cromata	€ 926,00
cod. 266. __/ISR chromed base/base cromata	€ 926,00
cod. 266. __/IDKR chromed base/base cromata	€ 1.102,00
cod. 266. __/IVR chromed base/base cromata	€ 898,00
cod. 266. __/IER chromed base/base cromata	€ 870,00
cod. 266. __/IMGR chromed base/base cromata	€ 898,00
cod. 266. __/ITCR chromed base/base cromata	€ 820,00

Fabric required
Fabbisogno di tessuto
4 pcs: Lin Mtrs 1,8 (h1,40)

COM fabric min. order
10pcs each code
Tessuto cliente TC ordine
min. 10pz per codice

Min. order 4pcs
each code
Ordine min 4pz
per codice

DRESS DAME U



Swivel in 4-blade aluminum painted base, with glides, padded and upholstered shell.
Girevole su basamento verniciato a 4 razze su piedini, scocca imbottita e rivestita.

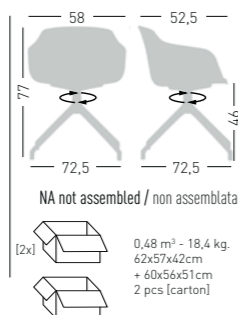

Frame Finishing & Codes / Finiture Telai e Codici

cod. 266. __/IKUB white painted/verniciato bianco	€ 892,00
cod. 266. __/IBUB white painted/verniciato bianco	€ 952,00
cod. 266. __/ISUB white painted/verniciato bianco	€ 952,00
cod. 266. __/IDKUB white painted/verniciato bianco	€ 1.050,00
cod. 266. __/IEUB white painted/verniciato bianco	€ 892,00
cod. 266. __/IPUB white painted/verniciato bianco	€ 1.050,00
cod. 266./ITCUB white painted/verniciato bianco	€ 852,00

cod. 266. __/IKUN black painted/verniciato nero	€ 892,00
cod. 266. __/IBUN black painted/verniciato nero	€ 952,00
cod. 266. __/ISUN black painted/verniciato nero	€ 952,00
cod. 266. __/IDKUN black painted/verniciato nero	€ 1.050,00
cod. 266. __/IEUN black painted/verniciato nero	€ 892,00
cod. 266. __/IPUN black painted/verniciato nero	€ 1.050,00
cod. 266./ITCUN black painted/verniciato nero	€ 852,00

Felt Glides / Tappi in feltro

Fabric required
Fabbisogno di tessuto
1 pc: Lin Mtrs 1,8 (h1,40)

COM fabric min. order
10pcs each code
Tessuto cliente TC ordine
min. 10pz per codice

Min. order 4pcs
each code
Ordine min 4pz
per codice

DRESS DAME UR



Swivel on 4-blade aluminum painted base, with castors, padded and upholstered shell.
Girevole su basamento verniciato in alluminio 4 razze su ruote, scocca imbottita e rivestita.

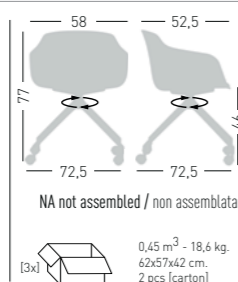

Frame Finishing & Codes / Finiture Telai e Codici

cod. 266. __/IKURB white painted/verniciato bianco	€ 918,00
cod. 266. __/IBURB white painted/verniciato bianco	€ 980,00
cod. 266. __/ISURB white painted/verniciato bianco	€ 980,00
cod. 266. __/IDKURB white painted/verniciato bianco	€ 1.076,00
cod. 266. __/IEURB white painted/verniciato bianco	€ 918,00
cod. 266. __/IPURB white painted/verniciato bianco	€ 1.076,00
cod. 266./ITCURB white painted/verniciato bianco	€ 878,00

cod. 266. __/IKURN black painted/verniciato nero	€ 918,00
cod. 266. __/IBURN black painted/verniciato nero	€ 980,00
cod. 266. __/ISURN black painted/verniciato nero	€ 980,00
cod. 266. __/IDKURN black painted/verniciato nero	€ 1.076,00
cod. 266. __/IEURN black painted/verniciato nero	€ 918,00
cod. 266. __/IPURN black painted/verniciato nero	€ 1.076,00
cod. 266./ITCURN black painted/verniciato nero	€ 878,00

Fabric required
Fabbisogno di tessuto
1 pc: Lin Mtrs 1,8 (h1,40)

COM fabric min. order
10pcs each code
Tessuto cliente TC ordine
min. 10pz per codice

Min. order 4pcs
each code
Ordine min 4pz
per codice



Eala

Frame / Struttura telaio

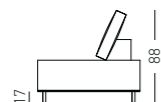

MG Maglia and FO Fortezza 93 coverings are suitable for outdoor use. In addition, MG Maglia is waterproof. I rivestimenti MG Maglia e FO Fortezza 93 sono adatti per un utilizzo Outdoor. Il rivestimento MG Maglia è inoltre impermeabile.

Available fabric / Tessuti disponibili
Fortezza 93 fabric / Tessuto Fortezza 93 **FO**
Maglia fabric / Tessuto Maglia **MG**

Cover available on request.
Disponibile su richiesta telo di copertura.

POUFF MODULE MODULO POUFF



High Density polyurethane foam, wooden structure supported by an aluminum and techno-polymer base, equipped with steel feet.
Poliuretano espanso ad alta densità, struttura in legno con cinghie elastiche e basamento in alluminio e tecnopolimero, dotato di piedini in acciaio.

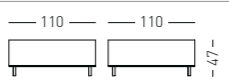

Feet to be assembled / Piedini da assemblare



Frame Finishing & Codes / Finiture Telaie e Codici

cod.420._/IFOA_
cod.420._/IMGA_

COM Fabric on request
Tessuto TC su richiesta

€ 2.468,00
€ 2.468,00

SMALL MODULE MODULO SMALL



High Density polyurethane foam, wooden structure supported by an aluminum and techno-polymer base, equipped with steel feet.
Poliuretano espanso ad alta densità, struttura in legno con cinghie elastiche e basamento in alluminio e tecnopolimero, dotato di piedini in acciaio.

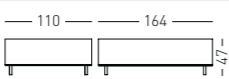

Feet to be assembled / Piedini da assemblare



Frame Finishing & Codes / Finiture Telaie e Codici

cod.421._/IFOA_
cod.421._/IMGA_

COM Fabric on request
Tessuto TC su richiesta

€ 3.284,00
€ 3.284,00

MEDIUM MODULE MODULO MEDIUM



High Density polyurethane foam, wooden structure supported by an aluminum and techno-polymer base, equipped with steel feet.
Poliuretano espanso ad alta densità, struttura in legno con cinghie elastiche e basamento in alluminio e tecnopolimero, dotato di piedini in acciaio.



Feet to be assembled / Piedini da assemblare



Frame Finishing & Codes / Finiture Telaie e Codici

cod.422._/IFOA_
cod.422._/IMGA_

COM Fabric on request
Tessuto TC su richiesta

€ 3.852,00
€ 3.852,00

LARGE MODULE MODULO LARGE



High Density polyurethane foam, wooden structure supported by an aluminum and techno-polymer base, equipped with steel feet.
Poliuretano espanso ad alta densità, struttura in legno con cinghie elastiche e basamento in alluminio e tecnopolimero, dotato di piedini in acciaio.

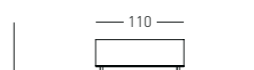

Feet to be assembled / Piedini da assemblare



Frame Finishing & Codes / Finiture Telaie e Codici

cod.423._/IFOA_
cod.423._/IMGA_

COM Fabric on request
Tessuto TC su richiesta

€ 4.210,00
€ 4.210,00

ARMREST BRACCIOLO



High Density polyurethane foam armrest.
Bracciolo in poliuretano espanso ad alta densità.

Available fabric.
Tessuti disponibili.
FO, MG

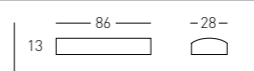

A assembled / assemblato



Frame Finishing & Codes / Finiture Telaie e Codici

cod.426._

COM Fabric on request
Tessuto TC su richiesta

€ 516,00

Cannot be sold individually
but only combined with sofa modules
Non vendibile singolarmente
ma solo abbinato ai moduli divano

BACKREST SUPPORTO SCHIENALE



High Density polyurethane foam with additional weight, anti-skid designed support.
Poliuretano espanso ad alta densità con zavorra, supporto progettato antiscivolo.

Available fabric.
Tessuti disponibili.
FO, MG

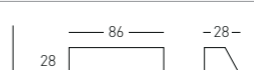

A assembled / assemblato



Frame Finishing & Codes / Finiture Telaie e Codici

cod.427._

COM Fabric on request
Tessuto TC su richiesta

€ 944,00

Cannot be sold individually
but only combined with sofa modules
Non vendibile singolarmente
ma solo abbinato ai moduli divano

CUSHION CUSCINO



Cushion in a mix of goose down and polyester fiber.
Cuscino in appoggio posizionabile in misto piuma d'oca e fibra di poliestere.

Available fabric.
Tessuti disponibili.
FO, MG

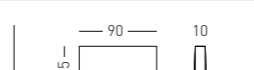

Frame Finishing & Codes / Finiture Telaie e Codici

cod.428._

COM Fabric on request
Tessuto TC su richiesta

€ 556,00

Cannot be sold individually
but only combined with sofa modules
Non vendibile singolarmente
ma solo abbinato ai moduli divano



Elodie

Available colors thermoformed back (front and back can be different)

Colori disponibili schienale termoformato (fronte e retro possono essere diversi)



The Elodie Collection coverings can be customized with a minimum order quantity of 100pcs.

La Collezione Elodie può essere personalizzata nei rivestimenti con quantità minima ordine pari a 100pz.

Available coverings / Finiture disponibili

King L fabric / Tessuto King L (4pcs min.)

King fabric / Tessuto King K (4pcs min.)

Blazer fabric / Tessuto Blazer B (4pcs min.)

Kvadrat fabrics / Tessuti Kvadrat DK (4pcs min.)

ELODIE TASK 05R



Swivel on 5-spur aluminium base, height adjustable, synchro mechanism weight sensitive, with arm, sound-absorbent backrest. Girevole su basamento 5 razze in alluminio, regolabile in altezza, meccanismo sincronizzato autopessante, con braccioli, schienale fonoassorbente.

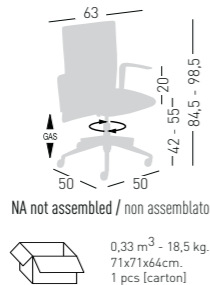

Frame Finishing & Codes / Finiture Telai e Codici

- cod.810._._/IL05RN € 1.186,00
- cod.810._._/IL05RB € 1.186,00
- cod.810._._/IK05RN € 1.186,00
- cod.810._._/IK05RB € 1.186,00
- cod.810._._/IB05RN € 1.234,00
- cod.810._._/IB05RB € 1.234,00
- cod.810._._/IDK05RN € 1.234,00
- cod.810._._/IDK05RB € 1.234,00

Twin color on demand
Bicolore su richiesta

Min. order 4pcs
each code
Ordine min 4pz
per codice

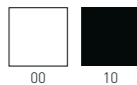

Armrests and base colors are combined
Colore dei braccioli è abbinato alla base

ELODIE MANAGER 05R



Swivel on 5-spur aluminium base, height adjustable, synchro mechanism weight sensitive, with arm, sound-absorbent backrest. Girevole su basamento 5 razze in alluminio, regolabile in altezza, meccanismo sincronizzato autopessante, con braccioli, schienale fonoassorbente.

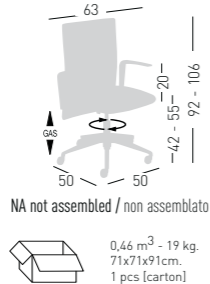

Frame Finishing & Codes / Finiture Telai e Codici

- cod.820._._/IL05RN € 1.332,00
- cod.820._._/IL05RB € 1.332,00
- cod.820._._/IK05RN € 1.332,00
- cod.820._._/IK05RB € 1.332,00
- cod.820._._/IB05RN € 1.380,00
- cod.820._._/IB05RB € 1.380,00
- cod.820._._/IDK05RN € 1.380,00
- cod.820._._/IDK05RB € 1.380,00

Twin color on demand
Bicolore su richiesta

Min. order 4pcs
each code
Ordine min 4pz
per codice

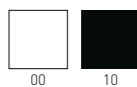

Armrests and base colors are combined
Colore dei braccioli è abbinato alla base

ELODIE EXECUTIVE 05R



Swivel on 5-spur aluminium base, height adjustable, synchro mechanism weight sensitive, with arm, sound-absorbent backrest. Girevole su basamento 5 razze in alluminio, regolabile in altezza, meccanismo sincronizzato autopessante, con braccioli, schienale fonoassorbente.

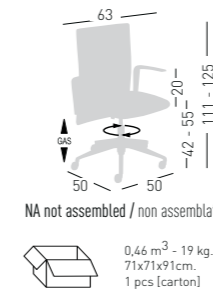

Armrests and base colors are combined
Colore dei braccioli è abbinato alla base

Frame Finishing & Codes / Finiture Telai e Codici

- cod.830._._/IL05RN € 1.598,00
- cod.830._._/IL05RB € 1.598,00
- cod.830._._/IK05RN € 1.598,00
- cod.830._._/IK05RB € 1.598,00
- cod.830._._/IB05RN € 1.646,00
- cod.830._._/IB05RB € 1.646,00
- cod.830._._/IDK05RN € 1.646,00
- cod.830._._/IDK05RB € 1.646,00

Twin color on demand
Bicolore su richiesta

Min. order 4pcs
each code
Ordine min 4pz
per codice

ELODIE TASK U



Swivel on 4-blade, synchro mechanism weight sensitive, sound-absorbent backrest. Girevole su basamento 4 razze, meccanismo sincronizzato autopessante, schienale fonoassorbente.

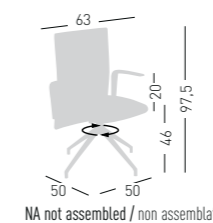

Armrests and base colors are combined
Colore dei braccioli è abbinato alla base

Frame Finishing & Codes / Finiture Telai e Codici

- cod.810._._/ILU_ with armrests/con braccioli € 1.186,00
- cod.810._._/IKU_ with armrests/con braccioli € 1.186,00
- cod.810._._/IBU_ with armrests/con braccioli € 1.234,00
- cod.810._._/IDKU_ with armrests/con braccioli € 1.234,00
- cod.811._._/ILU_ € 1.090,00
- cod.811._._/IKU_ € 1.090,00
- cod.811._._/IBU_ € 1.138,00
- cod.811._._/IDKU_ € 1.138,00

Felt Glides / Tappi in feltro

Twin color on demand
Bicolore su richiesta

Min. order 4pcs
each code
Ordine min 4pz
per codice

ELODIE MANAGER U



Swivel on 4-blade, synchro mechanism weight sensitive, sound-absorbent backrest. Girevole su basamento 4 razze, meccanismo sincronizzato autopessante, schienale fonoassorbente.

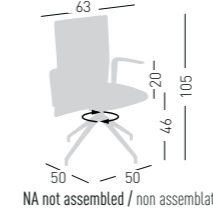

Armrests and base colors are combined
Colore dei braccioli è abbinato alla base

Frame Finishing & Codes / Finiture Telai e Codici

- cod.820._._/ILUN € 1.332,00
- cod.820._._/ILUB € 1.332,00
- cod.820._._/IKUN € 1.332,00
- cod.820._._/IKUB € 1.332,00
- cod.820._._/IBUN € 1.380,00
- cod.820._._/IBUB € 1.380,00
- cod.820._._/IDKUN € 1.380,00
- cod.820._._/IDKUB € 1.380,00

Felt Glides / Tappi in feltro

Twin color on demand
Bicolore su richiesta

Min. order 4pcs
each code
Ordine min 4pz
per codice

Epica



Available colors / Colori disponibili



EPICA FIX

Fix techno-polymer chair with cushion.
Sedia fissa in tecnopolimero con cuscino imbottito.



CATAS
TESTATO - TESTED

Available fabric.
Tessuti disponibili.
B, K, E, S, DK
COM fabric / Tessuto cliente **TC**

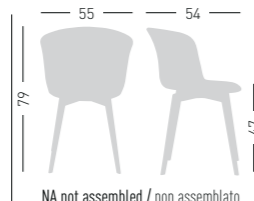

NA not assembled / non assemblato



0,37 m³ - 25 kg.
48x61x66,5cm.
59,5x56,5x51,5cm.
4 pcs (carton)

Frame Finishing & Codes / Finiture Telaie e Codici

cod. 350.__(K)/TP__	€ 254,00
cod. 350.__(E)/TP__	€ 254,00
cod. 350.__(B)/TP__	€ 270,00
cod. 350.__(S)/TP__	€ 266,00
cod. 350.__(DK)/TP__	€ 280,00
cod. 350.__(TC)/TP__ COM fabric/tessuto cliente	€ 244,00

Legs and shells colors can be combined
I colori delle gambe possono essere abbinati alla scocca

Fabric required
Fabbisogno di tessuto
4 pcs : Lin Mtrs 1 (h1,40)

COM fabric min. order
10pcs each code
Tessuto cliente TC ordine
min. 10pz per codice

Min. order 4pcs
each code
Ordine min 4pz
per codice

EPICA 360

Swivel techno-polymer chair with cushion.
Sedia girevole in tecnopolimero con cuscino imbottito.



Available fabric.
Tessuti disponibili.
B, K, E, S, DK
COM fabric / Tessuto cliente **TC**

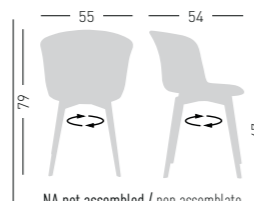

NA not assembled / non assemblato



0,37 m³ - 25 kg.
48x61x66,5cm.
59,5x56,5x51,5cm.
4 pcs (carton)

Frame Finishing & Codes / Finiture Telaie e Codici

cod. 351.__(K)/TP__	€ 254,00
cod. 351.__(E)/TP__	€ 254,00
cod. 351.__(B)/TP__	€ 270,00
cod. 351.__(S)/TP__	€ 266,00
cod. 351.__(DK)/TP__	€ 280,00
cod. 351.__(TC)/TP__ COM fabric/tessuto cliente	€ 244,00

Legs and shells colors can be combined
I colori delle gambe possono essere abbinati alla scocca

Fabric required
Fabbisogno di tessuto
4 pcs : Lin Mtrs 1 (h1,40)

COM fabric min. order
10pcs each code
Tessuto cliente TC ordine
min. 10pz per codice

Min. order 4pcs
each code
Ordine min 4pz
per codice

EPICA SR

Techno-polymer chair with cushion, swivel movement.
Sedia in tecnopolimero con movimento girevole, cuscino imbottito.



Available fabric.
Tessuti disponibili.
B, K, E, S, DK
COM fabric / Tessuto cliente **TC**

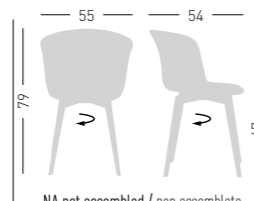

NA not assembled / non assemblato



0,37 m³ - 25 kg.
48x61x66,5cm.
59,5x56,5x51,5cm.
4 pcs (carton)

Frame Finishing & Codes / Finiture Telaie e Codici

cod. 352.__(K)/TP__	€ 254,00
cod. 352.__(E)/TP__	€ 254,00
cod. 352.__(B)/TP__	€ 270,00
cod. 352.__(S)/TP__	€ 266,00
cod. 352.__(DK)/TP__	€ 280,00
cod. 352.__(TC)/TP__ COM fabric/tessuto cliente	€ 244,00

Legs and shells colors can be combined
I colori delle gambe possono essere abbinati alla scocca

Fabric required
Fabbisogno di tessuto
4 pcs : Lin Mtrs 1 (h1,40)

COM fabric min. order
10pcs each code
Tessuto cliente TC ordine
min. 10pz per codice

Min. order 4pcs
each code
Ordine min 4pz
per codice

EPICA UPHOLSTERED IMBOTTITE

Available coverings / Finiture disponibili
Blazer fabric / Tessuto Blazer **B** (4pcs min.)
King fabric / Tessuto King **K** (4pcs min.)
Superb Trevira Velvet / Velluto Superb Trevira **S** (4pcs min.)
Kvadrat fabrics / Tessuti Kvadrat **DK** (4pcs min.)
COM fabric / Tessuto cliente **TC** (10pcs min.)

DRESS EPICA FIX

Fix upholstered chair.
Sedia fissa imbottita.

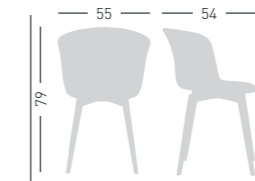

A assembled / assemblato



0,31 m³ - 7 kg.
61x55x93cm.
1 pcs (carton)

Frame Finishing & Codes / Finiture Telaie e Codici

cod.350.__(IBTP)__	€ 558,00
cod.350.__(ISTP)__	€ 558,00
cod.350.__(IKTP)__	€ 558,00
cod.350.__(IDKTP)__	€ 752,00
cod.350.__(ITCTP)__ COM fabric/tessuto cliente	€ 508,00

Fabric required
Fabbisogno di tessuto
1 pcs : Lin Mtrs 1,5 (h1,40)

COM fabric min. order
10pcs each code
Tessuto cliente TC ordine
min. 10pz per codice

Min. order 4pcs
each code
Ordine min 4pz
per codice

DRESS EPICA 360

Swivel upholstered chair.
Sedia girevole imbottita.

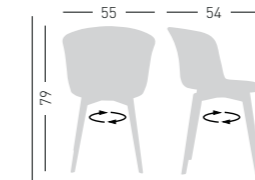

A assembled / assemblato



0,31 m³ - 7 kg.
61x55x93cm.
1 pcs (carton)

Frame Finishing & Codes / Finiture Telaie e Codici

cod.351.__(IBTP)__	€ 558,00
cod.351.__(ISTP)__	€ 558,00
cod.351.__(IKTP)__	€ 558,00
cod.351.__(IDKTP)__	€ 752,00
cod.351.__(ITCTP)__ COM fabric/tessuto cliente	€ 508,00

Fabric required
Fabbisogno di tessuto
1 pcs : Lin Mtrs 1,5 (h1,40)

COM fabric min. order
10pcs each code
Tessuto cliente TC ordine
min. 10pz per codice

Min. order 4pcs
each code
Ordine min 4pz
per codice

DRESS EPICA SR

Upholstered chair with swivel movement.
Sedia tappezzata con movimento girevole.

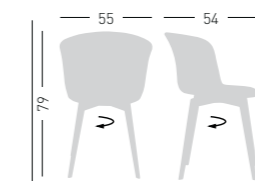

A assembled / assemblato



0,31 m³ - 7 kg.
61x55x93cm.
1 pcs (carton)

Frame Finishing & Codes / Finiture Telaie e Codici

cod.352.__(IBTP)__	€ 558,00
cod.352.__(ISTP)__	€ 558,00
cod.352.__(IKTP)__	€ 558,00
cod.352.__(IDKTP)__	€ 752,00
cod.352.__(ITCTP)__ COM fabric/tessuto cliente	€ 508,00

Fabric required
Fabbisogno di tessuto
1 pcs : Lin Mtrs 1,5 (h1,40)

COM fabric min. order
10pcs each code
Tessuto cliente TC ordine
min. 10pz per codice

Min. order 4pcs
each code
Ordine min 4pz
per codice



Etesian

Frame / Struttura telaio



MG Maglia and FO Fortezza 93 coverings are suitable for outdoor use. In addition, MG Maglia is waterproof. I rivestimenti MG Maglia e FO Fortezza 93 sono adatti per un utilizzo Outdoor. Il rivestimento MG Maglia è inoltre impermeabile.

Available fabric / Tessuti disponibili
Fortezza 93 fabric / Tessuto Fortezza 93 **FO**
Maglia fabric / Tessuto Maglia **MG**

Cover available on request.
Disponibile su richiesta telo di copertura.

**ETESIAN
MODULE 1**

Etesian pouf.
Pouf Etesian.

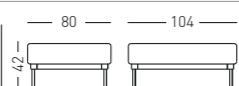

Feet to be assembled / Piedini da assemblare



0,36 m³ - 31 kg.
106x84x40 cm.
1 pc [carton]

Frame Finishing & Codes / Finiture Telaio e Codici

cod. 481, __/IFOA__
cod. 481, __/IMGA__

COM Fabric on request
Tessuto TC su richiesta

€ 1.400,00
€ 1.400,00

**ETESIAN
MODULE 2**

Etesian armchair.
Poltrona Etesian.



Feet to be assembled / Piedini da assemblare



0,72 m³ - 52 kg.
110x84x78 cm.
1 pc [carton]

Frame Finishing & Codes / Finiture Telaio e Codici

cod. 482, __/IFOA__
cod. 482, __/IMGA__

COM Fabric on request
Tessuto TC su richiesta

€ 2.040,00
€ 2.040,00

**ETESIAN
MODULE 3**

Etesian armchair with padded arms.
Poltrona con braccioli imbottiti Etesian.

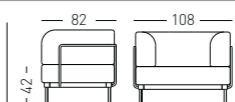

Feet to be assembled / Piedini da assemblare



0,72 m³ - 54 kg.
110x84x78 cm.
1 pc [carton]

Frame Finishing & Codes / Finiture Telaio e Codici

cod. 483, __/IFOA__
cod. 483, __/IMGA__

COM Fabric on request
Tessuto TC su richiesta

€ 2.380,00
€ 2.380,00

**ETESIAN
MODULE 4**

Etesian angular element SX.
Elemento angolare SX Etesian.

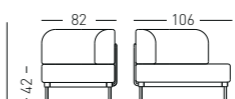

Feet to be assembled / Piedini da assemblare



0,72 m³ - 42 kg.
110x84x78 cm.
1 pc [carton]

Frame Finishing & Codes / Finiture Telaio e Codici

cod. 484, __/IFOA__
cod. 484, __/IMGA__

COM Fabric on request
Tessuto TC su richiesta

€ 2.120,00
€ 2.120,00

**ETESIAN
MODULE 5**

Etesian angular element DX.
Elemento angolare DX Etesian.

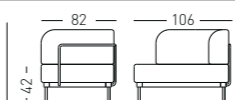

Feet to be assembled / Piedini da assemblare



0,72 m³ - 42 kg.
110x84x78 cm.
1 pc [carton]

Frame Finishing & Codes / Finiture Telaio e Codici

cod. 485, __/IFOA__
cod. 485, __/IMGA__

COM Fabric on request
Tessuto TC su richiesta

€ 2.120,00
€ 2.120,00

**ETESIAN
MODULE 6**

Etesian lounge pouf.
Lounge pouf Etesian.

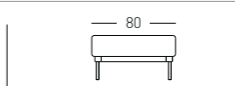

Feet to be assembled / Piedini da assemblare



0,56 m³ - 39 kg.
166x84x40 cm.
1 pc [carton]

Frame Finishing & Codes / Finiture Telaio e Codici

cod. 486, __/IFOA__
cod. 486, __/IMGA__

COM Fabric on request
Tessuto TC su richiesta

€ 1.700,00
€ 1.700,00

**ETESIAN
MODULE 7**

Etesian twin-seater sofa.
Divano a due posti Etesian.

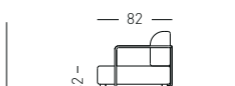

Feet to be assembled / Piedini da assemblare



1,88 m³ - 51 kg.
166x84x78 cm.
1 pc [carton]

Frame Finishing & Codes / Finiture Telaio e Codici

cod. 487, __/IFOA__
cod. 487, __/IMGA__

COM Fabric on request
Tessuto TC su richiesta

€ 2.800,00
€ 2.800,00

**ETESIAN
MODULE 8**

Etesian twin-seater sofa
with padded arms.
Divano a due posti
con braccioli imbottiti Etesian.

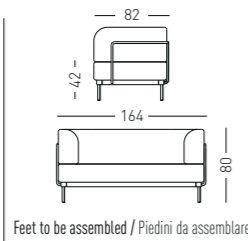

Feet to be assembled / Piedini da assemblare



1,07 m³ - 63 kg.
166x84x78 cm.
1 pc [carton]

Frame Finishing & Codes / Finiture Telaie e Codici

cod. 488,___/IFOA___
cod. 488,___/IMGA___

COM Fabric on request
Tessuto TC su richiesta

€ 3.360,00
€ 3.360,00

**ETESIAN
MODULE 9**

Etesian lounge SX.
Lounge SX Etesian.

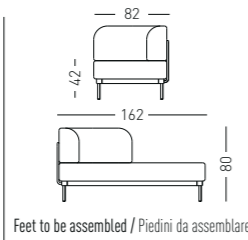

Feet to be assembled / Piedini da assemblare



1,07 m³ - 51 kg.
166x84x78 cm.
1 pc [carton]

Frame Finishing & Codes / Finiture Telaie e Codici

cod. 489,___/IFOA___
cod. 489,___/IMGA___

COM Fabric on request
Tessuto TC su richiesta

€ 2.440,00
€ 2.440,00

**ETESIAN
MODULE 10**

Etesian lounge DX.
Lounge DX Etesian.

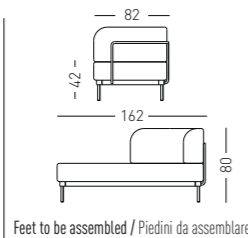

Feet to be assembled / Piedini da assemblare



1,07 m³ - 51 kg.
166x84x78 cm.
1 pc [carton]

Frame Finishing & Codes / Finiture Telaie e Codici

cod. 490,___/IFOA___
cod. 490,___/IMGA___

COM Fabric on request
Tessuto TC su richiesta

€ 2.440,00
€ 2.440,00

**ETESIAN
MODULE 11**

Etesian lounge with long back
support.
Lounge con supporto schienale lungo
Etesian.

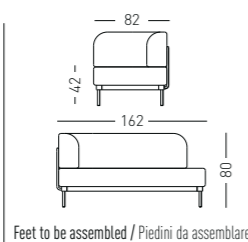

Feet to be assembled / Piedini da assemblare



1,88 m³ - 59 kg.
166x84x78 cm.
1 pc [carton]

Frame Finishing & Codes / Finiture Telaie e Codici

cod. 491,___/IFOA___
cod. 491,___/IMGA___

COM Fabric on request
Tessuto TC su richiesta

€ 3.000,00
€ 3.000,00

**ETESIAN
MODULE 12**

Etesian large lounge.
Large lounge Etesian.

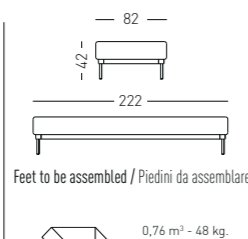

Feet to be assembled / Piedini da assemblare



0,76 m³ - 48 kg.
226x84x60 cm.
1 pc [carton]

Frame Finishing & Codes / Finiture Telaie e Codici

cod. 492,___/IFOA___
cod. 492,___/IMGA___

COM Fabric on request
Tessuto TC su richiesta

€ 2.000,00
€ 2.000,00

**ETESIAN
MODULE 13**

Etesian three-seater sofa.
Divano a tre posti Etesian.

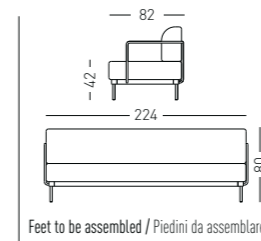

Feet to be assembled / Piedini da assemblare



1,48 m³ - 63 kg.
226x84x78 cm.
1 pc [carton]

Frame Finishing & Codes / Finiture Telaie e Codici

cod. 493,___/IFOA___
cod. 493,___/IMGA___

COM Fabric on request
Tessuto TC su richiesta

€ 3.500,00
€ 3.500,00

**ETESIAN
MODULE 14**

Etesian chaise longue SX.
Chaise longue SX Etesian.

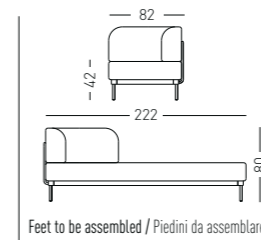

Feet to be assembled / Piedini da assemblare



1,48 m³ - 59 kg.
226x84x78 cm.
1 pc [carton]

Frame Finishing & Codes / Finiture Telaie e Codici

cod. 494,___/IFOA___
cod. 494,___/IMGA___

COM Fabric on request
Tessuto TC su richiesta

€ 3.100,00
€ 3.100,00

**ETESIAN
MODULE 15**

Etesian chaise longue DX.
Chaise longue DX Etesian.

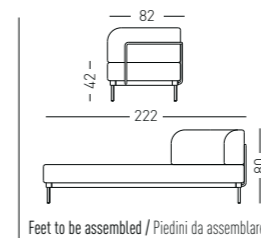

Feet to be assembled / Piedini da assemblare

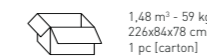

1,48 m³ - 59 kg.
226x84x78 cm.
1 pc [carton]

Frame Finishing & Codes / Finiture Telaie e Codici

cod. 495,___/IFOA___
cod. 495,___/IMGA___

COM Fabric on request
Tessuto TC su richiesta

€ 3.100,00
€ 3.100,00

**ETESIAN
MODULE 16**

Etesian chaise longue
with long back support.
Chaise longue con supporto
schienale lungo Etesian.

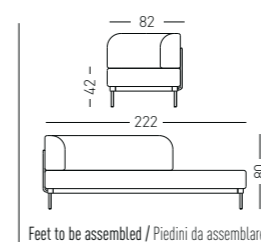

Feet to be assembled / Piedini da assemblare



1,48 m³ - 70 kg.
226x84x78 cm.
1 pc [carton]

Frame Finishing & Codes / Finiture Telaie e Codici

cod. 496,___/IFOA___
cod. 496,___/IMGA___

COM Fabric on request
Tessuto TC su richiesta

€ 3.600,00
€ 3.600,00

**ETESIAN
MODULE 17**

Etesian vis-a-vis version.
Versione vis a vis Etesian.

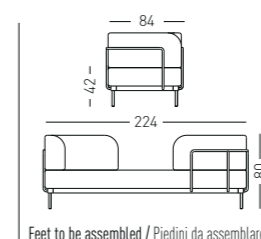

Feet to be assembled / Piedini da assemblare



1,48 m³ - 72 kg.
226x84x78 cm.
1 pc [carton]

Frame Finishing & Codes / Finiture Telaie e Codici

cod. 497,___/IFOA___
cod. 497,___/IMGA___

COM Fabric on request
Tessuto TC su richiesta

€ 3.720,00
€ 3.720,00



Available colors / Colori disponibili

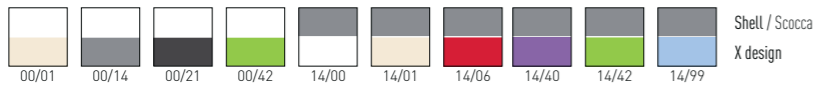

EXTREME



Painted 4-Legged metal frame, techno-polymer multicolor shell. Struttura in metallo 4 gambe verniciata, scocca in tecnopolimero multicolore.

CATAS
TESTATO - TESTED



only for painted frames
solo per telai verniciati



NA not assembled / non assemblato



0,24 m³ - 26 kg.
64x64x64cm.
4 pcs [carton]

Frame Finishing & Codes / Finiture Telai e Codici

cod.83.--/NAB white painted/verniciato bianco

€ 242,00



Available coverings / Finiture disponibili
King fabric / Tessuto King **K** (4pcs min.)

FINFERLO



Padded and upholstered King fabric ottoman. Pouf imbottito e tappezzato in tessuto King.

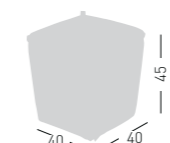

A assembled / assemblato



0,12 m³ - 4 kg.
43x46x60cm.
1 pcs [carton]

Frame Finishing & Codes / Finiture Telai e Codici

cod.250.--

The external covering is always grey.
Rivestimento esterno sempre grigio.

€ 474,00

Min. order 4pcs
each code
Ordine min 4pz
per codice

Flap



FLAP TROLLEY CARRELLO



Trolley for chairs, black painted metal structure with heavy duty castors, complete with adjustable safety strap.
Carrello porta sedie, struttura in metallo verniciato nero con ruote ad alta resistenza, completa di cinghia regolabile di sicurezza.

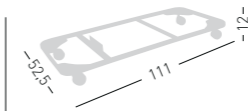

Max 24 chairs in a trolley
Massimo 24 sedie in un carrello



0,12 m³ - 10,20 kg.
123x62x16cm.
1 pcs [carton]

Codes / Codici

cod. 2004/A

€ 436,00

Available colors / Colori disponibili

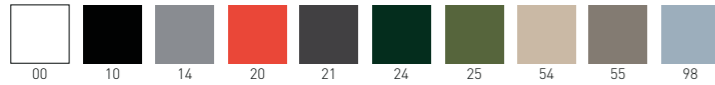

IGN Versions follows UNI 9177 certification in terms of Fire Resistance, Fire Reaction Class 1
Versioni IGN prodotto Omologato con Classe di Reazione al fuoco 1, UNI 9177



FLAP



Techno-polymer folding chair.
Seduta pieghevole in tecnopolimero.



Chairs can be piled / Sedie accatastabili
A assembled / assemblato



0,08 m³ - 12 kg.
108x49x15cm.
2 pcs [carton]

Frame Finishing & Codes / Finiture Telai e Codici

cod. 150. __/A

€ 154,00

cod. 150. __/IGN fire retardant / ignifuga

€ 202,00

Min. order 200pcs each code / Ordine min 200pz per codice

FLAP WALL HANGER AGGANCI A MURO



Technopolimer wall hanging to mount 2 chairs, black and white.
Aggancio a muro in tecnopolimero per 2 sedie, nero e bianco.

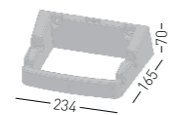

0,003 m³ - 0,26 kg.
8x24x17cm.
1 pcs [carton]

Codes / Codici

cod. 1064. __

€ 28,00

Available colors / Colori disponibili

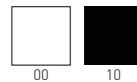

FLAP CONNECTING SYSTEM GANCI CONNESSIONE



Technopolimer linking devices for in-line disposal, white neutral color.
Agganci in tecnopolimero per disporre le sedute in linea, colore bianco neutro.

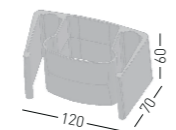

0,001 m³ - 1,6 kg.
14x13,5x46cm.
12 pcs [carton]

Codes / Codici

cod. 1007

€ 12,00

Fuller



Available colors / Colori disponibili

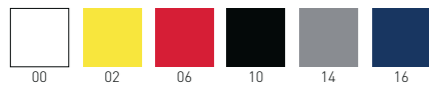

FULLER

Painted 4-legged metal frame, techno-polymer shell.
Struttura 4 gambe in metallo verniciata, scocca in tecnopolimero.



CATAS
TESTATO - TESTED



Legs and shell colors can be combined.
I colori della struttura e della scocca possono essere abbinati.

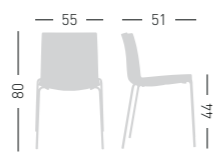

stackable / impilabile (6pcs)
A assembled / assemblato



Frame Finishing & Codes / Finiture Telai e Codici

cod.377._/AB	€ 258,00
cod.377._/AN	€ 258,00
cod.377._/AG	€ 258,00
cod.377._/A06	€ 258,00
cod.377._/A02	€ 258,00
cod.377._/A16	€ 258,00

FULLER B

Painted 4-legged metal frame with armrests, techno-polymer shell.
Struttura 4 gambe in metallo verniciata con braccioli, scocca in tecnopolimero.



Legs and shell colors can be combined.
I colori della struttura e della scocca possono essere abbinati.

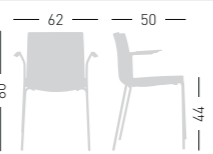

stackable / impilabile (6pcs)
A assembled / assemblato



Frame Finishing & Codes / Finiture Telai e Codici

cod.377._/TBB	€ 298,00
cod.377._/TBN	€ 298,00
cod.377._/TBG	€ 298,00
cod.377._/TB06	€ 298,00
cod.377._/TB02	€ 298,00
cod.377._/TB16	€ 298,00

FULLER ST

Painted sled metal frame, techno-polymer shell.
Struttura a slitta verniciata in metallo, scocca in tecnopolimero.



Legs and shell colors can be combined.
I colori della struttura e della scocca possono essere abbinati.

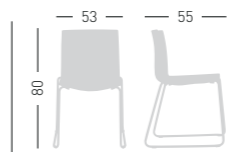

stackable / impilabile (6pcs)
A assembled / assemblato



Frame Finishing & Codes / Finiture Telai e Codici

cod.377._/STB	€ 268,00
cod.377._/STN	€ 268,00
cod.377._/STG	€ 268,00
cod.377._/ST06	€ 268,00
cod.377._/ST02	€ 268,00
cod.377._/ST16	€ 268,00

FULLER TC

Painted wire steel metal, techno-polymer shell.
Struttura a traliccio in filo verniciata in metallo, scocca in tecnopolimero.



Legs and shell colors can be combined.
I colori della struttura e della scocca possono essere abbinati.

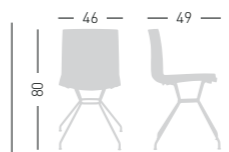

A assembled / assemblato



Frame Finishing & Codes / Finiture Telai e Codici

cod.377._/TCB	€ 298,00
cod.377._/TCN	€ 298,00
cod.377._/TCG	€ 298,00
cod.377._/TC06	€ 298,00
cod.377._/TC02	€ 298,00
cod.377._/TC16	€ 298,00

FULLER TCS

Painted wire steel metal with armrests, techno-polymer shell.
Struttura a traliccio in filo verniciata in metallo con braccioli, scocca in tecnopolimero.



Legs and shell colors can be combined.
I colori della struttura e della scocca possono essere abbinati.

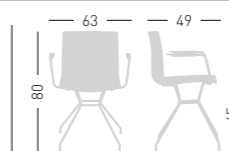

A assembled / assemblato



Frame Finishing & Codes / Finiture Telai e Codici

cod.377._/TCSB	€ 324,00
cod.377._/TCSN	€ 324,00
cod.377._/TCSG	€ 324,00
cod.377._/TCS06	€ 324,00
cod.377._/TCS02	€ 324,00
cod.377._/TCS16	€ 324,00



Available colors / Colori disponibili



GRAND MINUSH

Techno-polymer armchair with co-injected metal frame.
Poltrona in tecnopolimero con telaio metallico co-iniettato.

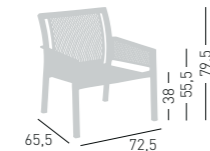

NA not assembled / non assemblato



Frame Finishing & Codes / Finiture Telai e Codici

cod.222.--/NA

€ 344,00

MINUSH SOFA

2 seat techno-polymer bench with co-injected metal frame.
Panca 2 posti in tecnopolimero con telaio metallico co-iniettato.

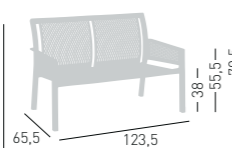

NA not assembled / non assemblato



Frame Finishing & Codes / Finiture Telai e Codici

cod.223.--/NA

€ 522,00

GRAND MINUSH CUSHION / CUSCINO

Cushions set, seat and back.
Set cuscini, sedile e schienale.



Available fabric / Tessuti disponibili
Progarden fabric / Tessuto Progarden **GR**
Silververtex Fabric / Tessuto Silververtex **SX**
Maglia fabric / Tessuto Maglia **MG**



Frame Finishing & Codes / Finiture Telai e Codici

cod.320.-- (GR)
cod.320.-- (SX)
cod.320.-- (MG)

€ 214,00
€ 270,00
€ 270,00

Min. order 2pcs each code
Ordine min 2pz per codice

MINUSH SOFA CUSHION / CUSCINO

Cushions set, seat and back.
Set cuscini, sedile e schienale.



Available fabric / Tessuti disponibili
Progarden fabric / Tessuto Progarden **GR**
Silververtex Fabric / Tessuto Silververtex **SX**
Maglia fabric / Tessuto Maglia **MG**



Inside bench boxes
Nella scatola delle panche.

Frame Finishing & Codes / Finiture Telai e Codici

cod.323.-- (GR)
cod.323.-- (SX)
cod.323.-- (MG)

€ 346,00
€ 416,00
€ 416,00

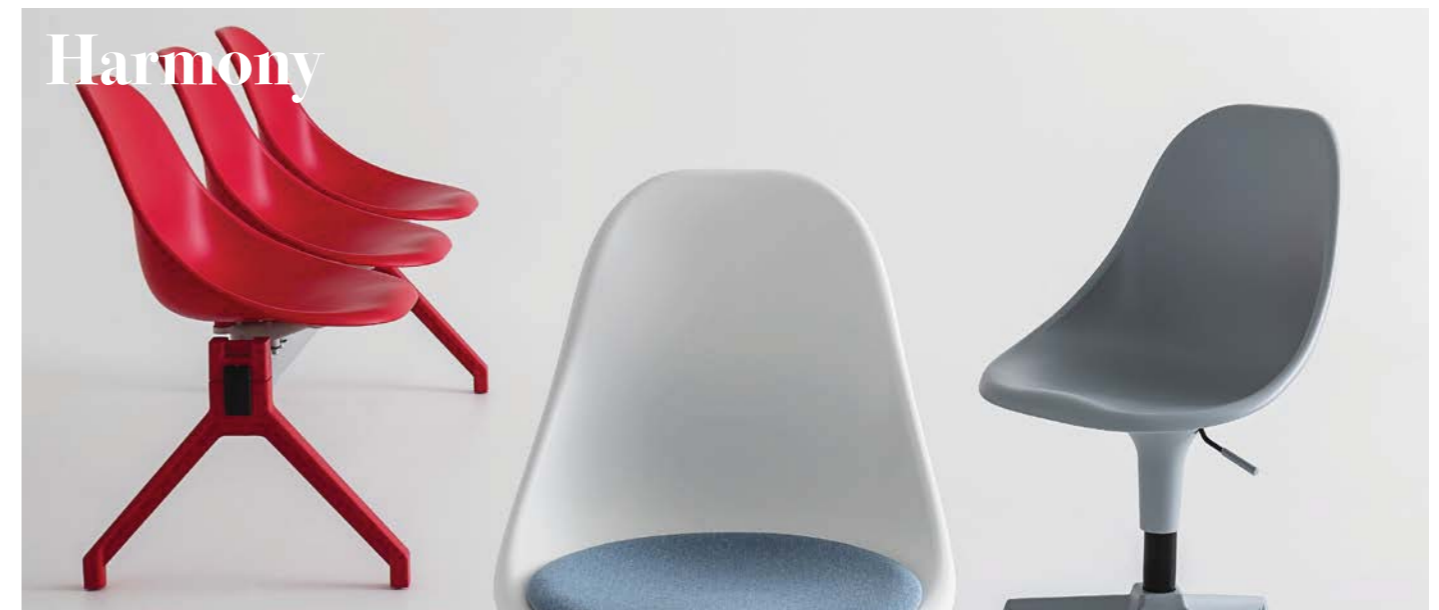

Available colors / Colori disponibili



HARMONY BTP

Swivel on polymer-metal co-injected base, diam. 40cm. Height adjustable, techno-polymer shell.
Girevole su basamento co-iniettato metallo-polimero diam. 40cm, regolabile in altezza, scocca in tecnopolimero.

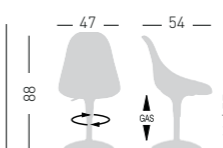

NA not assembled / non assemblato



Frame Finishing & Codes / Finiture Telai e Codici

cod.24.--/BTP

€ 266,00

HARMONY BTV

Swivel on chromed metal base, diam. 44cm. Height adjustable, techno-polymer shell.
Girevole su basamento in metallo cromato diam. 44cm, regolabile in altezza, scocca in tecnopolimero.

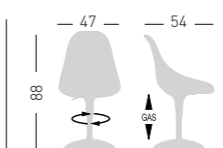

NA not assembled / non assemblato



Frame Finishing & Codes / Finiture Telai e Codici

cod.24.--/BTV

€ 292,00

HARMONY BC



Swivel on 5-spur base with castors, height adjustable, techno-polymer shell.
Girevole su basamento 5 razze con ruote, regolabile in altezza, scocca in tecnopolimero.

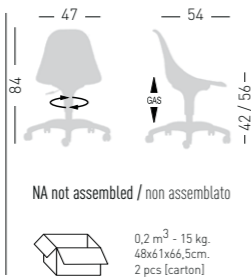

Frame Finishing & Codes / Finiture Telai e Codici

cod.24.--/BC

€ **262,00**

HARMONY BP



Swivel on 4-spur plastic grey base, height adjustable, techno-polymer shell.
Girevole su basamento 4 razze in plastica grigio, regolabile in altezza, scocca in tecnopolimero.

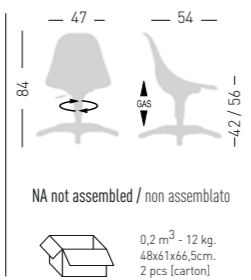

Frame Finishing & Codes / Finiture Telai e Codici

cod.24.--/BP

€ **202,00**

HARMONY PG



2-3-4-5 seat benches, metal-polymer co-injected legs, techno-polymer shell.
Panca a 2-3-4-5 posti, gambe co-iniettate in metallo-polimero, scocca in tecnopolimero.

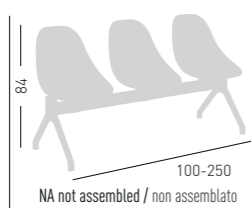

Frame Finishing & Codes / Finiture Telai e Codici

0,28 m³ - 18,5 kg, 1 pcs (carton) **cod.24.--/PG2P (100 cm)**

€ **584,00**

0,29 m³ - 21,7 kg, 1 pcs (carton) **cod.24.--/PG3P (150 cm)**

€ **658,00**

0,30 m³ - 25 kg, 1 pcs (carton) **cod.24.--/PG4P (200 cm)**

€ **732,00**

0,31 m³ - 29,2 kg, 1 pcs (carton) **cod.24.--/PG5P (250 cm)**

€ **808,00**

It is possible to change a seat with a grey metal top
È possibile sostituire la seduta con un tavolino in metallo grigio

HARMONY CUSHION / CUSCINO



Upholstered cushion.
Cuscino tappezzato.

Available fabric.
Tessuti disponibili.
E, K
COM fabric / Tessuto cliente **TC**

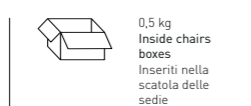

Frame Finishing & Codes / Finiture Telai e Codici

cod.301.--

€ **92,00**

cod.301.TC COM fabric/tessuto cliente

€ **78,00**

Fabric required
Fabbisogno di tessuto
4 pcs: Lin Mtrs 1 (h1,40)

COM fabric min. order
10pcs each code
Tessuto cliente TC ordine
min. 10pz per codice

Min. order 4pcs
each code
Ordine min 4pz
per codice



Available colors / Colori disponibili

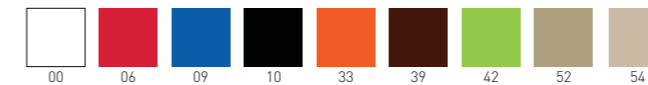

IGN Versions follows UNI 9177 certification in terms of Fire Resistance, Fire Reaction Class 1
Versioni IGN prodotto Omologato con Classe di Reazione al fuoco 1, UNI 9177



IRIS



4 legget polymer-metal co-injected structure, techno-polymer shell.
Struttura 4 gambe in co-iniezione metallo-polimero, scocca in tecnopolimero.



CAM ARREDI

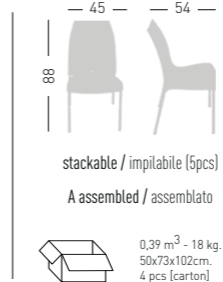

Frame Finishing & Codes / Finiture Telai e Codici

cod.181.--/A

€ **116,00**

cod.181.--/IGNA fire retardant / ignifuga
Min. order 300pcs each code / Ordine min 300pz per codice

€ **156,00**

IRIS B



4 legget polymer-metal co-injected structure, techno-polymer shell with arms.
Struttura 4 gambe in co-iniezione metallo-polimero, scocca in tecnopolimero con braccioli.



CAM ARREDI

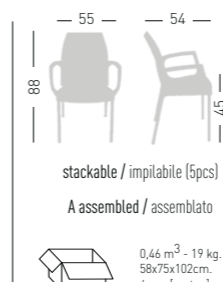

Frame Finishing & Codes / Finiture Telai e Codici

cod.182.--/A

€ **128,00**

cod.182.--/IGNA fire retardant / ignifuga
Min. order 300pcs each code / Ordine min 300pz per codice

€ **214,00**

IRIS BL



4-Legged wooden beech legs, techno-polymer shell.
Struttura 4 gambe in legno di faggio, scocca in tecnopolimero.

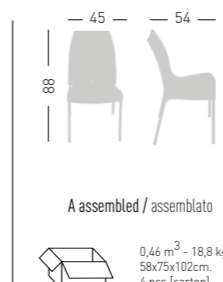

Frame Finishing & Codes / Finiture Telai e Codici

cod.181.--/BL_

€ **166,00**

Min. order 100pcs each code / Ordine min 100pz per codice
Felt Glides / Tappi in feltro

IRIS BL B



4-Legged wooden beech legs, techno-polymer shell with armrests. Struttura 4 gambe in legno di faggio, scocca in tecnopolimero con braccioli.

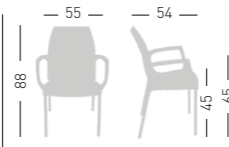

A assembled / assemblato

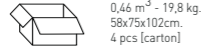

0,46 m³ - 19,8 kg.
58x75x102cm.
4 pcs (carton)

Frame Finishing & Codes / Finiture Telai e Codici

cod.182.--/BL_

Min. order 100pcs each code / Ordine min 100pz per codice

Felt Glides / Tappi in feltro

€ **176,00**



IRIS CHAIRS TROLLEY CARRELLO PER SEDIE



Trolley for chairs model Iris, black painted. Carrello porta sedie modello Iris, verniciato nero.

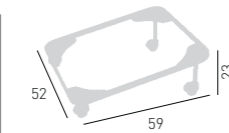

0,09 m³ - 5,5kg
61x54x25cm.
1 pcs (carton)

Frame Finishing & Codes / Finiture Telai e Codici

cod.2002/A

€ **222,00**



Available colors / Colori disponibili

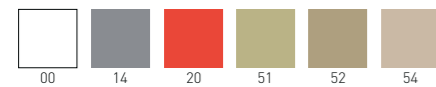

ISIDORA



4-legged stackable techno-polymer chair. Seduta impilabile in tecnopolimero.

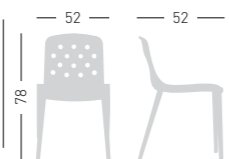

stackable / impilabile (6pcs)
A assembled / assemblato



0,38 m³ - 16 kg.
59x72x90cm.
4 pcs (carton)

Frame Finishing & Codes / Finiture Telai e Codici

cod.380.--/A

€ **166,00**



ISIDORA B



4-legged stackable techno-polymer chair with armrests. Seduta impilabile in tecnopolimero con braccioli.

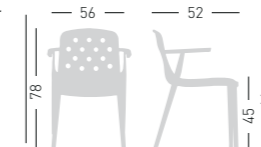

stackable / impilabile (6pcs)
A assembled / assemblato



0,38 m³ - 18,4 kg.
59x72x90cm.
4 pcs (carton)

Frame Finishing & Codes / Finiture Telai e Codici

cod.381.--/A

€ **184,00**

ISIDORA CUSHION / CUSCINO

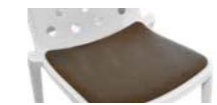

Cushion available with Aurea eco-leather or King fabric. Cuscino Ecopelle Aurea o tessuto King.



0,6 kg
Inside chairs boxes
Inseriti nella scatola delle sedie

Frame Finishing & Codes / Finiture Telai e Codici

cod.312.--

cod.312.TC COM fabric/tessuto cliente

€ **106,00**

€ **92,00**

Fabric required
Fabbisogno di tessuto
4 pcs: Lin Mtrs 1,0 (h1,40)

COM fabric min. order
10pcs each code
Tessuto cliente TC ordine
min. 10pz per codice

Min. order 4pcs
each code
Ordine min 4pz
per codice

Available fabric.
Tessuti disponibili.
E, K

COM fabric / Tessuto cliente **TC** (10 pcs min)

ISIDORA UPHOLSTERED IMBOTTITE

Available coverings / Finiture disponibili
Aurea eco-leather / Ecopelle Aurea **E** (4pcs min.)
King fabric / Tessuto King **K** (4pcs min.)
COM fabric / Tessuto cliente **TC** (10pcs min.)

DRESS ISIDORA



Techno-polymer upholstered chair. Seduta in tecnopolimero rivestita.

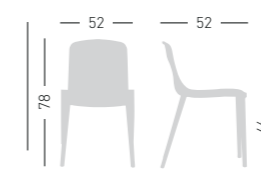

NA seat panel not assembled /
cuscino non assemblato

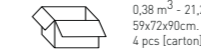

0,38 m³ - 21,2 kg.
59x72x90cm.
4 pcs (carton)

Frame Finishing & Codes / Finiture Telai e Codici

cod.380.--.--/IEA

cod.380.--.--/IKA

cod.380.--.--/ITCA COM fabric/tessuto cliente

€ **388,00**

€ **388,00**

€ **356,00**

Fabric required
Fabbisogno di tessuto
2 pcs: Lin Mtrs 1,5 (h1,40)

COM fabric min. order
10pcs each code
Tessuto cliente TC ordine
min. 10pz per codice

Min. order 4pcs
each code
Ordine min 4pz
per codice

Glossy back coverings colors
can be combined with the shell.
I colori dei retro-schienali lucidi
possono essere abbinati alla
scocca.

DRESS ISIDORA B



Techno-polymer upholstered chair with armrests. Seduta in tecnopolimero rivestita con braccioli.

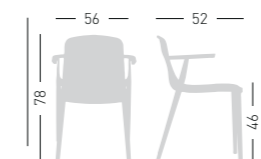

NA seat panel not assembled /
cuscino non assemblato

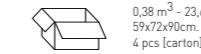

0,38 m³ - 23,6 kg.
59x72x90cm.
4 pcs (carton)

Frame Finishing & Codes / Finiture Telai e Codici

cod.381.--.--/IEA

cod.381.--.--/IKA

cod.381.--.--/ITCA COM fabric/tessuto cliente

€ **408,00**

€ **408,00**

€ **376,00**

Fabric required
Fabbisogno di tessuto
2 pcs: Lin Mtrs 1,5 (h1,40)

COM fabric min. order
10pcs each code
Tessuto cliente TC ordine
min. 10pz per codice

Min. order 4pcs
each code
Ordine min 4pz
per codice

Glossy back coverings colors
can be combined with the shell.
I colori dei retro-schienali lucidi
possono essere abbinati alla
scocca.

Jubel



IGN Versions follows UNI 9177 certification in terms of Fire Resistance, Fire Reaction Class 1
Versioni IGN prodotto Omologato con Classe di Reazione al fuoco 1, UNI 9177



Available colors / Colori disponibili

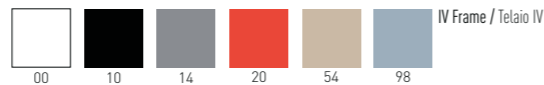
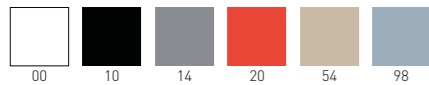

IV Frame / Telaio IV

JUBEL NA



Chromed or painted 4-Legged metal frame, techno-polymer shell.
Struttura in metallo 4 gambe, cromata o verniciata, scocca in tecnopolimero.



CAM ARREDI



only for painted frames
solo per telai verniciati

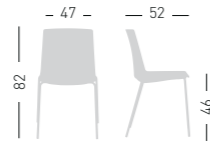

stackable / impilabile (5pcs)
NA not assembled / non assemblato



0,25 m³ - 21 kg.
67x56x64,5cm.
4 pcs (carton)

Frame Finishing & Codes / Finiture Telai e Codici

cod.291._/NA chromed/cromata
cod.291._/NAB white painted/verniciato bianco
cod.291._/NAN black painted/verniciato nero

€ 192,00
€ 222,00
€ 222,00

cod.291._/IGNNA
fire retardant, chromed framed
ignifuga, telaio cromato
Minimum order 300pcs/ Ordine minimo 300pz

€ 258,00

JUBEL TB



Chromed or painted 4-Legged metal frame with armrests, techno-polymer shell.
Struttura in metallo 4 gambe con braccioli, cromata o verniciata, scocca in tecnopolimero.



only for painted frames
solo per telai verniciati

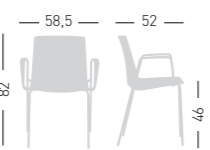

stackable / impilabile (4pcs)
NA not assembled / non assemblato



0,31 m³ - 13 kg.
61x55x93cm.
2 pcs (carton)

Frame Finishing & Codes / Finiture Telai e Codici

cod.291._/TB chromed/cromata
cod.291._/TBB white painted/verniciato bianco
cod.291._/TBN black painted/verniciato nero

€ 244,00
€ 268,00
€ 268,00

Armrest white for shells cod. 00-52-54-98
Armrest black for shells cod. 10-14-20
Bracciolo bianco per scocche cod. 00-52-54-98
Bracciolo nero per scocche cod. 10-14-20

In case of painted frame, armrests color are combined with frame colors.
Nel caso di telai verniciati, il colore dei braccioli segue il colore dei telai.

JUBEL S



Chromed or painted wire steel sled frame, techno-polymer shell.
Struttura a slitta in filo, cromata o verniciata, scocca in tecnopolimero.



only for painted frames
solo per telai verniciati

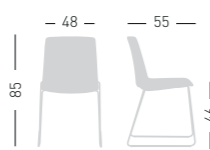

stackable / impilabile (8pcs)
NA not assembled / non assemblato

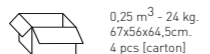

0,25 m³ - 24 kg.
67x56x64,5cm.
4 pcs (carton)

Frame Finishing & Codes / Finiture Telai e Codici

cod.291._/S chromed/cromata
cod.291._/SB white painted/verniciato bianco
cod.291._/SN black painted/verniciato nero

€ 192,00
€ 222,00
€ 222,00

JUBEL SS



Chromed or white painted wire steel sled frame with armrests, techno-polymer shell.
Struttura a slitta in filo con braccioli, cromata o verniciata bianca, scocca in tecnopolimero.



only for painted frames
solo per telai verniciati

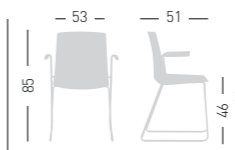

stackable / impilabile (8pcs)
NA not assembled / non assemblato



0,31 m³ - 13,50 kg.
61x55x93cm.
2 pcs (carton)

Frame Finishing & Codes / Finiture Telai e Codici

cod.291._/SS chromed/cromata
cod.291._/SSB white painted/verniciato bianco

€ 244,00
€ 268,00

The arm pads are in the same color of the shell
Il copribraziolo è dello stesso colore della scocca

JUBEL BL



4-Legged wooden beech frame, techno-polymer shell.
Struttura in legno di faggio 4 gambe, scocca in tecnopolimero.



F

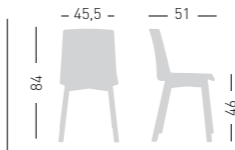

NA not assembled / non assemblato

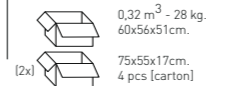

0,32 m³ - 28 kg.
60x56x51cm.
2x 75x55x17cm.
4 pcs (carton)

Frame Finishing & Codes / Finiture Telai e Codici

cod.291._/BLF

€ 460,00

Felt Glides / Tappi in feltro

JUBEL 5R



Swivel on 5-blade polished aluminum base, height adjustable, techno-polymer shell with castors.
Girevole su basamento 5 razze in alluminio pulito con ruote, regolabile in altezza, scocca in tecnopolimero.



NA not assembled / non assemblato



0,24 m³ - 19 kg.
66x55x63cm.
2 pcs (carton)

Frame Finishing & Codes / Finiture Telai e Codici

cod.291._/5R polished/lucida

€ 426,00

JUBEL 5R BRACCIOLO



Swivel on 5-blade polished aluminum base, height adjustable, techno-polymer shell, armrests with castors.
Girevole su basamento 5 razze in alluminio pulito con ruote, regolabile in altezza, scocca in tecnopolimero, braccioli.

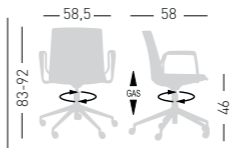

NA not assembled / non assemblato



0,24 m³ - 22 kg.
66x55x63cm.
2 pcs (carton)

Frame Finishing & Codes / Finiture Telai e Codici

cod.291._/5RB polished/lucida

€ 464,00

Armrest white for shells cod. 00-14-20-52-54-98
Armrest black for shells cod. 10
Bracciolo bianco per scocche cod. 00-14-20-52-54-98
Bracciolo nero per scocche cod. 10

JUBEL L



Swivel on 4-blade polished aluminum base, techno-polymer shell.
Girevole su basamento 4 razze in alluminio pulito, scocca in tecnopolimero.

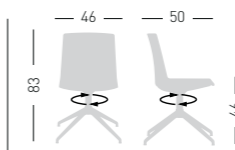

NA not assembled / non assemblato



0,24 m³ - 16 kg.
66x55x63cm.
2 pcs (carton)

Frame Finishing & Codes / Finiture Telai e Codici

cod.291._/L polished/lucida

€ 386,00

Felt Glides / Tappi in feltro

JUBEL L BRACCIOLO



Swivel on 4-blade polished aluminum base, techno-polymer shell, armrests. Girevole su basamento 4 razze in alluminio pulito, scocca in tecnopolimero, braccioli.

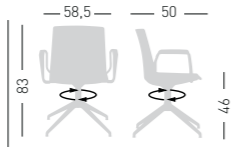

NA not assembled / non assemblato
0,24 m³ - 19 kg.
66x55x63cm.
2 pcs [carton]

Frame Finishing & Codes / Finiture Telai e Codici

cod.291.___/LB polished/lucidata

€ **424,00**

Armrest white for shells cod. 00-14-20-52-54-98
Armrest black for shells cod. 10
Bracciolo bianco per scocche cod. 00-14-20-52-54-98
Bracciolo nero per scocche cod.10

Felt Glides / Tappi in feltro

JUBEL IV



4-legged polymer-steel coinjecte structure, techno-polymer shell. Struttura 4 gambe in co-iniezione metallo-polimero, scocca in tecnopolimero.

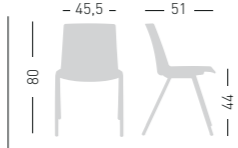

stackable / impilabile
A assembled / assemblato
0,38 m³ - 25 kg.
59x65x99cm.
4 pcs [carton]

Frame Finishing & Codes / Finiture Telai e Codici

cod.291.___/IV__

€ **240,00**

cod.291.___/IGNIV__ fire retardant / ignifuga
Min. order 300pcs each code / Ordine min 300pz per codice

€ **306,00**

JUBEL IVB



4-legged polymer-steel coinjecte structure with armrests, techno-polymer shell. Struttura 4 gambe in co-iniezione metallo-polimero con braccioli, scocca in tecnopolimero.

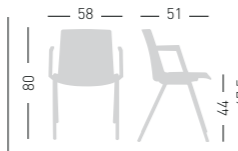

stackable / impilabile
A assembled / assemblato
0,38 m³ - 28 kg.
59x65x99cm.
4 pcs [carton]

Frame Finishing & Codes / Finiture Telai e Codici

cod.291.___/IVB__

€ **338,00**

cod.291.___/IGNIVB__ fire retardant / ignifuga
Min. order 300pcs each code / Ordine min 300pz per codice

€ **404,00**

JUBEL IVBT



4-legged polymer-steel coinjecte structure with armrests and antipanic tablet, techno-polymer shell. Struttura 4 gambe in co-iniezione metallo-polimero con braccioli e tavoletta antipanico, scocca in tecnopolimero.

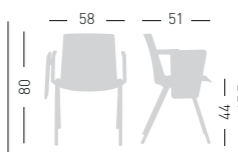

stackable / impilabile
NA not assembled / non assemblato
0,38 m³ - 29 kg.
59x65x99cm.
4 pcs [carton]

Frame Finishing & Codes / Finiture Telai e Codici

cod.291.___/IVB__T

€ **488,00**

cod.291.___/IGNIVB__T fire retardant / ignifuga
Min. order 300pcs each code / Ordine min 300pz per codice

€ **554,00**

Frame / Telaio

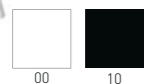

JUBEL PG



2-3-4-5 seat benches, metal-polymer co-injected legs, techno-polymer shell. Panca a 2-3-4-5 posti, gambe co-iniettate in metallo-polimero, scocca in tecnopolimero.



NA not assembled / non assemblato

Frame Finishing & Codes / Finiture Telai e Codici

cod.291.___/PG2P__ (100 cm)

€ **636,00**

cod.291.___/PG3P__ (150 cm)

€ **740,00**

cod.291.___/PG4P__ (200 cm)

€ **840,00**

cod.291.___/PG5P__ (250 cm)

€ **942,00**

Bench legs available colors: 00-06-10-13-14-33-34-42
It is possible to change a seat with a grey metal top.
Outdoor version on request.
Colori disponibili gambe panca: 00-06-10-13-14-33-34-42
È possibile sostituire la seduta con un tavolino in metallo grigio. Versione per esterni su richiesta.

JUBEL CUSHION / CUSCINO



Upholstered cushion. Cuscino tappezzato.

Available fabric. Tessuti disponibili.
B, E, K, DK
COM fabric / Tessuto cliente TC



0,5 kg.
Inside chairs boxes
Nella scatola delle sedie.

Frame Finishing & Codes / Finiture Telai e Codici

cod.315.-- (B)

€ **122,00**

cod.315.-- (E)

€ **106,00**

cod.315.-- (K)

€ **106,00**

cod.315.-- (DK)

€ **130,00**

cod.315.TC COM fabric/tessuto cliente

€ **92,00**

Minimum order 4pcs each code
Ordine minimo 4 pezzi per codice

COM fabric minimum order 10pcs each code
Tessuto cliente TC ordine minimo 10pz per codice

Fabric required / Fabbisogno di tessuto
4 pcs : Lin Mtrs 1 (h1,40)

JUBEL CONNECTING SYSTEM GANCIO CONNESSIONE



Extensible chromed linking devices for in-line disposal. Agganci estensibili cromati per disporre le sedute in linea.



Inside chairs boxes
Nella scatola delle sedie.

Frame Finishing & Codes / Finiture Telai e Codici

cod.1004

€ **44,00**

available for models: NA, TB, S, SS, SST
disponibile per versioni: NA, TB, S, SS, SST

JUBEL CONNECTING SYSTEM GANCIO CONNESSIONE



Set linking glides for in-line disposal. Set piedini con agganci per disporre le sedute in linea.



Inside chairs boxes
Nella scatola delle sedie.

Assembled / assemblato

Frame Finishing & Codes / Finiture Telai e Codici

cod.1014

€ **20,00**

available for models: S, SST
disponibile per versioni: S, SST

JUBEL IV CONNECTING SYSTEM GANCIO CONNESSIONE



Extensible techno-polymer linking devices for in-line disposal. Agganci estensibili in tecnopolimero per disporre le sedute in linea.



Inside chairs boxes
Nella scatola delle sedie.

Assembled / assemblato

Frame Finishing & Codes / Finiture Telai e Codici

cod.1024.10

€ **44,00**

available for models: IV
disponibile per versioni: IV

JUBEL CHAIRS TROLLEY CARRELLO PER SEDIE



Trolley for chairs, chromed metal structure. Carrello porta sedie, struttura in metallo cromato.



0,3 m³ - 10kg
63x75x58cm.
1 pcs [carton]

Frame Finishing & Codes / Finiture Telai e Codici

cod.2000/A

€ **242,00**

available for models: S-SS
disponibile per versioni: S-SS

stackable on trolley 18 pcs
impilabili su carrello 18 pcs

max height with 18 chairs 188 cm
altezza carrello con 18 sedie 188 cm

JUBEL CHAIRS TROLLEY CARRELLO PER SEDIE



Painted grey adjustable Dolly, for 4 legged chairs.
Carrello per sedie 4 gambe, regolabile, verniciato grigio.

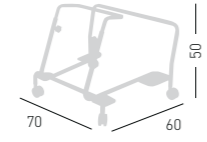

0,3 m³ - 8kg
62x72x51cm.
1 pcs [carton]

Frame Finishing & Codes / Finiture Telai e Codici

cod.2001/A € **290,00**

available for models: NA
disponibile per versioni: NA

JUBEL IV CHAIRS TROLLEY CARRELLO PER SEDIE



Trolley for chairs, black painted.
Carrello porta sedie, verniciato nero.

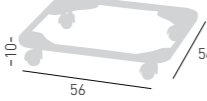

0,09 m³ - 6kg
61x61x20cm.
1 pcs [carton]

Frame Finishing & Codes / Finiture Telai e Codici

cod.2003/A € **276,00**

available for models: IV
disponibile per versioni: IV

JUBEL UPHOLSTERED IMBOTTITE

Products follows UNI 9175 -UNI 9175/FA, in terms of Fire Resistance, Fire Reation Class 11M
Prodotto Omologato dal Ministero dell'Interno, secondo la UNI 9175 -UNI 9175/FA, con classe di Reazione al fuoco 11M



Available coverings / Rivestimenti disponibili
Aurea eco-leather / Ecopelle Aurea **E** (4pcs min.)
King fabric / Tessuto King **K** (4pcs min.)
Kvadrat fabrics / Tessuti Kvadrat **DK** (4pcs min.)
COM fabric / Tessuto cliente **TC** (10pcs min.)

JUBEL NA UPHOLSTERED



PU-Flex padded and upholstered shell, chromed or painted 4 legged metal frame.
Scocca imbottita in PU-Flex e rivestita, telaio 4 gambe in metallo cromato o verniciato.

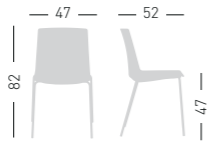

NA not assembled / non assemblato

0,25 m³ - 14 kg.
67x56x64,5cm.
2 pcs [carton]

Frame Finishing & Codes / Finiture Telai e Codici

cod.291._/IENA chromed/cromata € **388,00**
cod.291._/IENAB white painted/verniciato bianco € **416,00**
cod.291._/IENAN black painted/verniciato nero € **416,00**
cod.291._/IKNA chromed/cromata € **388,00**
cod.291._/IKNAB white painted/verniciato bianco € **416,00**
cod.291._/IKNAN black painted/verniciato nero € **416,00**
cod.291._/IDKNA chromed/cromata € **524,00**
cod.291._/IDKNAB white painted/verniciato bianco € **552,00**
cod.291._/IDKNAN black painted/verniciato nero € **552,00**
cod.291._/ITCNA chromed/cromata € **336,00**
cod.291._/ITCNAB white painted/verniciato bianco € **366,00**
cod.291._/ITCNAN black painted/verniciato nero € **366,00**

Fabric required
Fabbisogno di tessuto
1 pcs: Lin Mtrs 1,0 (h1,40)

COM fabric min. order
10pcs each code
Tessuto cliente TC ordine
min. 10pz per codice

Min. order 4pcs
each code
Ordine min 4pz
per codice

JUBEL TB UPHOLSTERED



PU-Flex padded and upholstered shell, chromed or painted 4 legged metal frame with armrests.
Scocca imbottita in PU-Flex e rivestita, telaio 4 gambe in metallo cromato o verniciato, con braccioli.

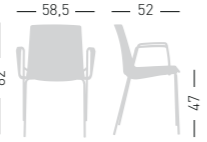

NA not assembled / non assemblato

0,31 m³ - 15 kg.
61x55x93cm.
2 pcs [carton]

Frame Finishing & Codes / Finiture Telai e Codici

cod.291._/IETB chromed/cromata € **438,00**
cod.291._/IETBB white painted/verniciato bianco € **462,00**
cod.291._/IETBN black painted/verniciato nero € **462,00**
cod.291._/IKTB chromed/cromata € **438,00**
cod.291._/IKTBB white painted/verniciato bianco € **462,00**
cod.291._/IKTBN black painted/verniciato nero € **462,00**
cod.291._/IDKTB chromed/cromata € **574,00**
cod.291._/IDKTB white painted/verniciato bianco € **598,00**
cod.291._/IDKTB black painted/verniciato nero € **598,00**
cod.291._/ITCTB chromed/cromata € **388,00**
cod.291._/ITCTBB white painted/verniciato bianco € **412,00**
cod.291._/ITCTBN black painted/verniciato nero € **412,00**

Fabric required
Fabbisogno di tessuto
1 pcs: Lin Mtrs 1,0 (h1,40)

COM fabric min. order
10pcs each code
Tessuto cliente TC ordine
min. 10pz per codice

Min. order 4pcs
each code
Ordine min 4pz
per codice

Specify on the order the colour of the armrest: white or black
Specificare nell'ordine il colore del bracciolo: bianco o nero

JUBEL S UPHOLSTERED



PU-Flex padded and upholstered shell, chromed or painted wire steel sled frame.
Scocca imbottita in PU-Flex e rivestita, telaio slitta in filo cromato o verniciato.

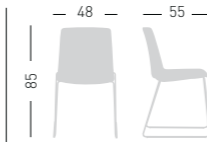

NA not assembled / non assemblato

0,25 m³ - 16 kg.
67x56x64,5cm.
2 pcs [carton]

Frame Finishing & Codes / Finiture Telai e Codici

cod.291._/IES chromed/cromata € **388,00**
cod.291._/IESB white painted/verniciato bianco € **416,00**
cod.291._/IESN black painted/verniciato nero € **416,00**
cod.291._/IKS chromed/cromata € **388,00**
cod.291._/IKSB white painted/verniciato bianco € **416,00**
cod.291._/IKSN black painted/verniciato nero € **416,00**
cod.291._/IDKS chromed/cromata € **524,00**
cod.291._/IDKSB white painted/verniciato bianco € **552,00**
cod.291._/IDKSN black painted/verniciato nero € **552,00**
cod.291./ITCS chromed/cromata € **336,00**
cod.291./ITCSB white painted/verniciato bianco € **366,00**
cod.291./ITCSN black painted/verniciato nero € **366,00**

Fabric required
Fabbisogno di tessuto
1 pcs: Lin Mtrs 1,0 (h1,40)

COM fabric min. order
10pcs each code
Tessuto cliente TC ordine
min. 10pz per codice

Min. order 4pcs
each code
Ordine min 4pz
per codice

JUBEL SS UPHOLSTERED



PU-Flex padded and upholstered shell, chromed or painted wire steel sled frame with armrests.
Scocca imbottita in PU-Flex e rivestita, telaio slitta in filo cromato o verniciato con braccioli.

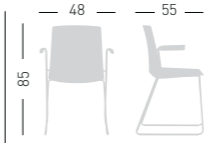

NA not assembled / non assemblato

0,31 m³ - 16 kg.
61x55x93cm.
2 pcs [carton]

Frame Finishing & Codes / Finiture Telai e Codici

cod.291._/IESS chromed/cromata € **440,00**
cod.291._/IESSB white painted/verniciato bianco € **464,00**
cod.291._/IKSS chromed/cromata € **440,00**
cod.291._/IKSSB white painted/verniciato bianco € **464,00**
cod.291._/IDKSS chromed/cromata € **576,00**
cod.291._/IDKSSB white painted/verniciato bianco € **600,00**
cod.291./ITCSS chromed/cromata € **390,00**
cod.291./ITCSSB white painted/verniciato bianco € **414,00**

Fabric required
Fabbisogno di tessuto
1 pcs: Lin Mtrs 1,0 (h1,40)

COM fabric min. order
10pcs each code
Tessuto cliente TC ordine
min. 10pz per codice

Min. order 4pcs
each code
Ordine min 4pz
per codice

Specify on the order the colour of the armrest: white or black
Specificare nell'ordine il colore del bracciolo: bianco o nero

JUBEL BL UPHOLSTERED



4-Legged wooden beech frame, PU-Flex padded and upholstered shell.
Struttura in legno di faggio 4 gambe, scocca imbottita in PU-Flex e rivestita

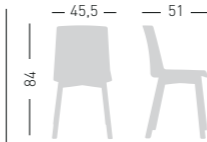

NA not assembled / non assemblato

0,32 m³ - 34 kg.
66x55x63cm.
(2x) 75x55x17cm.
4 pcs [carton]

Frame Finishing & Codes / Finiture Telai e Codici

cod.291._/IEBLF € **654,00**
cod.291._/IKBLF € **654,00**
cod.291._/IDKBLF € **790,00**
cod.291./ITCBLF € **602,00**

Felt Glides / Tappi in feltro

Fabric required
Fabbisogno di tessuto
1 pcs: Lin Mtrs 1,0 (h1,40)

COM fabric min. order
10pcs each code
Tessuto cliente TC ordine
min. 10pz per codice

Min. order 4pcs
each code
Ordine min 4pz
per codice

JUBEL 5R UPHOLSTERED



PU-Flex padded and upholstered shell, polished aluminum base with castors.
Scocca imbottita in PU-Flex e rivestita, base in alluminio pulito con ruote.

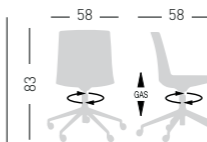

NA not assembled / non assemblato

0,24 m³ - 21 kg.
66x55x63cm.
2 pcs [carton]

Frame Finishing & Codes / Finiture Telai e Codici

cod.291._/IE5R polished/lucida € **620,00**
cod.291._/IK5R polished/lucida € **620,00**
cod.291._/IDK5R cpolished/lucida € **754,00**
cod.291./ITC5R polished/lucida € **570,00**

Fabric required
Fabbisogno di tessuto
1 pcs: Lin Mtrs 1,0 (h1,40)

COM fabric min. order
10pcs each code
Tessuto cliente TC ordine
min. 10pz per codice

Min. order 4pcs
each code
Ordine min 4pz
per codice

JUBEL L UPHOLSTERED



PU-Flex padded and upholstered shell, polished aluminum base.
Scocca imbottita in PU-Flex e rivestita, base in alluminio pulito.

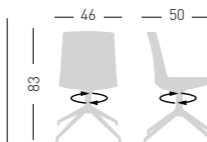

NA not assembled / non assemblato

0,24 m³ - 18 kg.
66x55x63cm.
2 pcs [carton]

Frame Finishing & Codes / Finiture Telai e Codici

cod.291._/IEL polished/lucida € **578,00**
cod.291._/IKL polished/lucida € **578,00**
cod.291._/IDKL polished/lucida € **716,00**
cod.291./ITCL polished/lucida € **528,00**

Felt Glides / Tappi in feltro

Fabric required
Fabbisogno di tessuto
1 pcs: Lin Mtrs 1,0 (h1,40)

COM fabric min. order
10pcs each code
Tessuto cliente TC ordine
min. 10pz per codice

Min. order 4pcs
each code
Ordine min 4pz
per codice

**JUBEL 5R
BRACCIOLO
UPHOLSTERED**



PU-Flex padded and upholstered shell, polished aluminum base with castors, armrests. Scocca imbottita in PU-Flex e rivestita, base in alluminio pulito con ruote, braccioli.

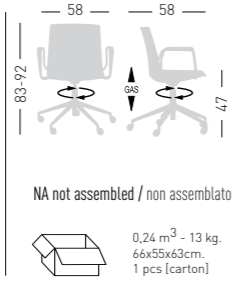

Frame Finishing & Codes / Finiture Telai e Codici

cod.291._/IE5RB polished/lucida	€	658,00
cod.291._/IK5RB polished/lucida	€	658,00
cod.291._/IDK5RB polished/lucida	€	794,00
cod.291/ITC5RB polished/lucida	€	608,00

Fabric required
Fabbisogno di tessuto
1 pcs: Lin Mtrs 1,0 (h1,40)

COM fabric min. order
10pcs each code
Tessuto cliente TC ordine
min. 10pz per codice

Min. order 4pcs
each code
Ordine min 4pz
per codice

Specify on the order the colour of the armrest: white or black
Specificare nell'ordine il colore del bracciolo: bianco o nero

**JUBEL L
BRACCIOLO
UPHOLSTERED**



PU-Flex padded and upholstered shell, polished aluminum base, armrests. Scocca imbottita in PU-Flex e rivestita, base in alluminio pulito, braccioli.

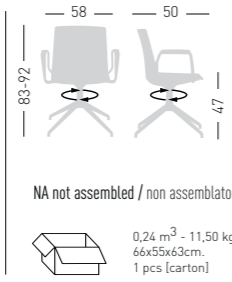

Frame Finishing & Codes / Finiture Telai e Codici

cod.291._/IELB polished/lucida	€	618,00
cod.291._/IKLB polished/lucida	€	618,00
cod.291._/IDKLB polished/lucida	€	752,00
cod.291/ITCLB polished/lucida	€	566,00

Felt Glides / Tappi in feltro

Fabric required
Fabbisogno di tessuto
1 pcs: Lin Mtrs 1,0 (h1,40)

COM fabric min. order
10pcs each code
Tessuto cliente TC ordine
min. 10pz per codice

Min. order 4pcs
each code
Ordine min 4pz
per codice

Specify on the order the colour of the armrest: white or black
Specificare nell'ordine il colore del bracciolo: bianco o nero

**JUBEL IV
UPHOLSTERED**



4-legged polymer-steel conjoined structure, PU-Flex padded and upholstered shell. Struttura 4 gambe in co-iniezione metallo-polimero, scocca imbottita in PU-Flex e rivestita.

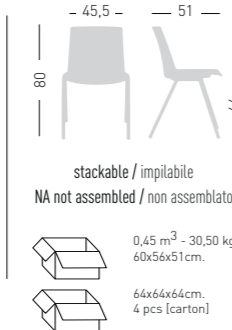

Frame Finishing & Codes / Finiture Telai e Codici

cod.291._/IEIV	€	436,00
cod.291._/IKIV	€	436,00
cod.291._/IDKIV	€	572,00
cod.291/ITCIV	€	386,00

Fabric required
Fabbisogno di tessuto
1 pcs: Lin Mtrs 1,0 (h1,40)

COM fabric min. order
10pcs each code
Tessuto cliente TC ordine
min. 10pz per codice

Min. order 4pcs
each code
Ordine min 4pz
per codice

**JUBEL IVB
UPHOLSTERED**



4-legged polymer-steel conjoined structure with armrests, PU-Flex padded and upholstered shell. Struttura 4 gambe in co-iniezione metallo-polimero con braccioli, scocca imbottita in PU-Flex e rivestita.

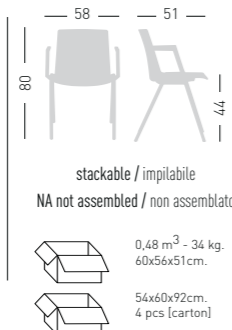

Frame Finishing & Codes / Finiture Telai e Codici

cod.291._/IEIVB	€	548,00
cod.291._/IKIVB	€	548,00
cod.291._/IDKIVB	€	682,00
cod.291/ITCIVB	€	498,00

Fabric required
Fabbisogno di tessuto
1 pcs: Lin Mtrs 1,0 (h1,40)

COM fabric min. order
10pcs each code
Tessuto cliente TC ordine
min. 10pz per codice

Min. order 4pcs
each code
Ordine min 4pz
per codice

**JUBEL IVBT
UPHOLSTERED**



4-legged polymer-steel conjoined structure with armrests and antipanico tablet, PU-Flex padded and upholstered shell. Struttura 4 gambe in co-iniezione metallo-polimero con braccioli e tavoletta antipanico, scocca imbottita in PU-Flex e rivestita.

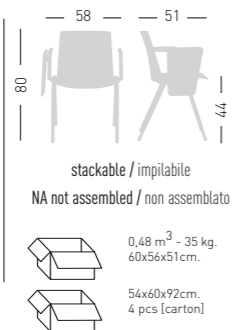

Frame Finishing & Codes / Finiture Telai e Codici

cod.291._/IEIVB_T	€	684,00
cod.291._/IKIVB_T	€	684,00
cod.291._/IDKIVB_T	€	820,00
cod.291/ITCIVB_T	€	634,00

Fabric required
Fabbisogno di tessuto
1 pcs: Lin Mtrs 1,0 (h1,40)

COM fabric min. order
10pcs each code
Tessuto cliente TC ordine
min. 10pz per codice

Min. order 4pcs
each code
Ordine min 4pz
per codice

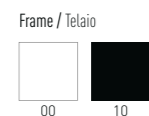

**JUBEL PG
UPHOLSTERED**



PU-Flex padded and upholstered shell, bench version. Scocca imbottita in PU-Flex e rivestita, versione panca.

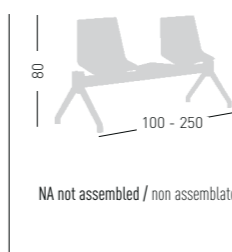

Fabric required
Fabbisogno di tessuto
1 pcs: Lin Mtrs 1,0 (h1,40)

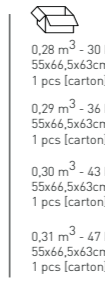

0,28 m³ - 30 kg,
55x66,5x63cm,
1 pcs [carton]
0,29 m³ - 36 kg,
55x66,5x63cm,
1 pcs [carton]
0,30 m³ - 43 kg,
55x66,5x63cm,
1 pcs [carton]
0,31 m³ - 47 kg,
55x66,5x63cm,
1 pcs [carton]

Frame Finishing & Codes / Finiture Telai e Codici

cod.291._/IEPG2P (100 cm)	€	1.026,00
cod.291._/IEPG3P (150 cm)	€	1.324,00
cod.291._/IEPG4P (200 cm)	€	1.622,00
cod.291._/IEPG5P (250 cm)	€	1.918,00
cod.291._/IKPG2P (100 cm)	€	1.026,00
cod.291._/IKPG3P (150 cm)	€	1.324,00
cod.291._/IKPG4P (200 cm)	€	1.622,00
cod.291._/IKPG5P (250 cm)	€	1.918,00
cod.291._/IDKPG2P (100 cm)	€	1.298,00
cod.291._/IDKPG3P (150 cm)	€	1.732,00
cod.291._/IDKPG4P (200 cm)	€	2.162,00
cod.291._/IDKPG5P (250 cm)	€	2.596,00
cod.291/ITCPG2P (100 cm)	€	924,00
cod.291/ITCPG3P (150 cm)	€	1.170,00
cod.291/ITCPG4P (200 cm)	€	1.416,00
cod.291/ITCPG5P (250 cm)	€	1.666,00

Bench legs available colors: 00-06-10-13-14-33-34-42
It is possible to change a seat with a grey metal top
Colori disponibili gambe panca: 00-06-10-13-14-33-34-42
E' possibile sostituire la seduta con un tavolino grigio in metallo



Available colors / Colori disponibili

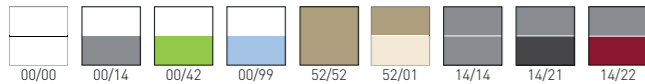

Frame / Telaio
Seat & Back / Seduta e Schienale

KALIPA

Techno-polymer twin-material chair.
Sedia realizzata in tecnopolimero bi-materiale.

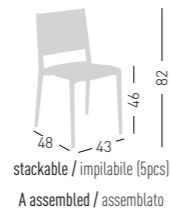

stackable / impilabile (5pcs)
A assembled / assemblato

Frame Finishing & Codes / Finiture Telaio e Codici

cod.246.--./A

€ 158,00

KALIPA B

Techno-polymer twin-material chair with integrated armrests.
Sedia realizzata in tecnopolimero bi-materiale con braccioli integrati.

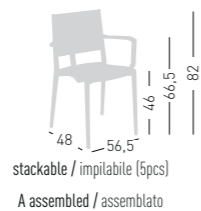

stackable / impilabile (5pcs)
A assembled / assemblato

Frame Finishing & Codes / Finiture Telaio e Codici

cod.247.--./A

€ 184,00

KALIPA CUSHION / CUSCINO

Cushion upholstered with Aurea eco-leather or King fabric.
Cuscino Ecopelle Aurea o tessuto King.

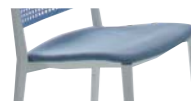

Available fabric.
Tessuti disponibili.
E, K
COM fabric / Tessuto cliente **TC**



Frame Finishing & Codes / Finiture Telaio e Codici

cod.306.--
cod.306.TC COM fabric/tessuto cliente

€ 96,00
€ 88,00

Fabric required
Fabbisogno di tessuto
4 pcs: Lin Mtrs 1,0 (h1,40)

COM fabric min. order
10pcs each code
Tessuto cliente TC ordine
min. 10pz per codice
Min. order 4pcs
each code
Ordine min 4pz
per codice



Available colors / Colori disponibili

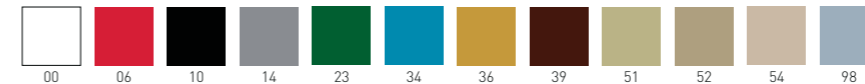

IGN Versions follows UNI 9177 certification in terms of
Fire Resistance, Fire Reaction Class 1
Versioni IGN prodotto Omologato con Classe di Reazione al
fuoco 1, UNI 9177



KANVAS NA

Chromed, black or white painted 4-Legged metal frame, techno-polymer shell.
Struttura in metallo 4 gambe, cromata, verniciata nera o bianca, scocca in tecnopolimero.



only for paintend frames
solo per telai verniciati

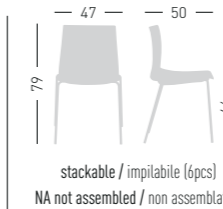

stackable / impilabile (6pcs)
NA not assembled / non assemblato

0,24 m³ - 20 kg.
66x55x63cm.
4 pcs (carton)

Frame Finishing & Codes / Finiture Telaio e Codici

cod. 360.--/NA chromed/cromata
cod. 360.--/NAB white painted/verniciato bianco
cod. 360.--/NAN black painted/verniciato nero

€ 160,00
€ 192,00
€ 192,00

cod. 360.00/IGNNA
white color, chromed frame, fire retardant/
colore bianco, telaio cromato, ignifuga
Minimum order 20pcs/ Ordine minimo 20pz

€ 216,00

cod. 360.--/IGNNA
chromed frame, fire retardant/
telaio cromato, ignifuga
Minimum order 300pcs/ Ordine minimo 300pz

€ 216,00

KANVAS TB

Chromed or white painted 4-Legged metal frame with armrests, techno-polymer shell.
Struttura in metallo 4 gambe con braccioli, cromata o verniciata bianca, scocca in tecnopolimero.



only for paintend frames
solo per telai verniciati

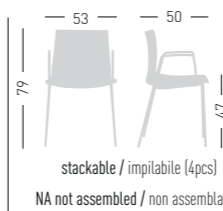

stackable / impilabile (4pcs)
NA not assembled / non assemblato

0,24 m³ - 12,40 kg.
60x55x75cm.
2 pcs (carton)

Frame Finishing & Codes / Finiture Telaio e Codici

cod. 360.--/TB chromed/cromata
cod. 360.--/TBB white painted/verniciato bianco

€ 192,00
€ 240,00

KANVAS S

Chromed, black or white painted wire steel sled frame, techno-polymer shell.
Struttura a slitta in filo, cromata, verniciata nera o bianca, scocca in tecnopolimero.



only for paintend frames
solo per telai verniciati

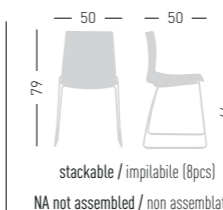

stackable / impilabile (8pcs)
NA not assembled / non assemblato

0,24 m³ - 24,50 kg.
66x55x63cm.
4 pcs (carton)

Frame Finishing & Codes / Finiture Telaio e Codici

cod. 360.--/S chromed/cromata
cod. 360.--/SB white painted/verniciato bianco
cod. 360.--/SN black painted/verniciato nero

€ 160,00
€ 192,00
€ 192,00

KANVAS ST



Chromed or painted sled steel frame, techno-polymer shell.
Struttura a slitta, cromata o verniciata, scocca in tecnopolimero.



only for paintend frames
solo per telai verniciati

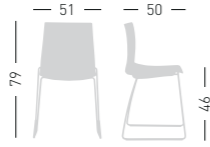

stackable / impilabile (6pcs)
NA not assembled / non assemblato



0,24 m³ - 22 kg.
66x55x63cm.
4 pcs (carton)

Frame Finishing & Codes / Finiture Telai e Codici

cod. 360.--/ST chromed/cromata
cod. 360.--/STB white painted/verniciato bianco
cod. 360.--/STN black painted/verniciato nero

€ 174,00
€ 210,00
€ 210,00

KANVAS Z



Chromed "Z" steel frame, stackable, techno-polymer shell.
Struttura in metallo cromato "Z", impilabile, scocca in tecnopolimero.

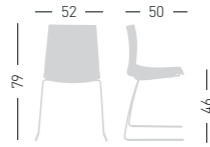

stackable / impilabile (4pcs)
NA not assembled / non assemblato



0,24 m³ - 22 kg.
66x55x63cm.
4 pcs (carton)

Frame Finishing & Codes / Finiture Telai e Codici

cod. 360.--/Z chromed/cromata

€ 188,00

KANVAS TC



Chromed or painted wire steel metal frame, techno-polymer shell.
Struttura a traliccio in filo, cromata o verniciata, scocca in tecnopolimero.



only for paintend frames
solo per telai verniciati

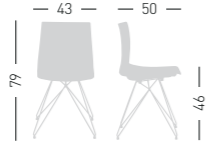

NA not assembled / non assemblato

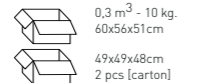

0,3 m³ - 10 kg.
60x56x51cm
49x49x68cm
2 pcs (carton)

Frame Finishing & Codes / Finiture Telai e Codici

cod. 360.--/TC chromed/cromata
cod. 360.--/TCB white painted/verniciato bianco
cod. 360.--/TCN black painted/verniciato nero

€ 178,00
€ 214,00
€ 214,00

KANVAS T5R



Swivel on 5-blade polished aluminum base with castors, height adjustable, techno-polymer shell.
Girevole su basamento 5 razze in alluminio pulito con ruote, regolabile in altezza, scocca in tecnopolimero.

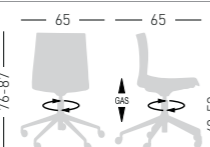

NA not assembled / non assemblato

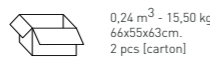

0,24 m³ - 15,50 kg.
66x55x63cm.
2 pcs (carton)

Frame Finishing & Codes / Finiture Telai e Codici

cod. 360._/T5R polished/pulita

€ 418,00

KANVAS T5R BR



Swivel on 5-blade polished aluminum base with castors, height adjustable, techno-polymer shell, armrests.
Girevole su basamento 5 razze in alluminio pulito con ruote, regolabile in altezza, scocca in tecnopolimero, braccioli.

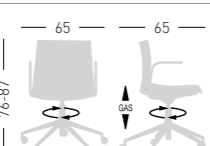

NA not assembled / non assemblato

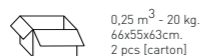

0,25 m³ - 20 kg.
66x55x63cm.
2 pcs (carton)

Frame Finishing & Codes / Finiture Telai e Codici

cod. 360._/_/T5RB polished/pulita

€ 250,00

Armrests available colors
Colori per braccioli disponibili
00-06-10-14-51-54

KANVAS BL



4-Legged wooden beech frame, techno-polymer shell.
Struttura in legno di faggio 4 gambe, scocca in tecnopolimero.

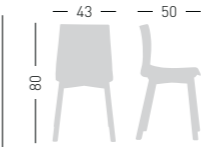

NA not assembled / non assemblato

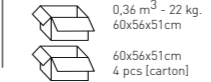

0,36 m³ - 22 kg.
60x56x51cm
60x56x51cm
4 pcs (carton)

Frame Finishing & Codes / Finiture Telai e Codici

cod. 360.--/BLF

Felt Glides / Tappi in feltro

€ 420,00

KANVAS TG



Stackable chromed 4 legged frame, aluminum anti-panic joint, scratch resistant tablet, techno-polymer shell.
Struttura impilabile 4 gambe cromata, snodo antipánico in alluminio, tavoletta resistente al graffito, scocca in tecnopolimero.



stackable / impilabile (4pcs)
NA not assembled / non assemblato



0,28 m³ - 13,8 kg.
59x53x91cm.
2 pcs (carton)

Frame Finishing & Codes / Finiture Telai e Codici

cod. 360._/NATG chromed frame/struttura cromata

€ 412,00

Min. order 20pcs
Ordine min 20pz

KANVAS PG



2-3-4-5 seat benches, metal-polymer co-injected legs, techno-polymer shell.
Panca a 2-3-4-5 posti, gambe co-iniettate in metallo-polimero, scocca in tecnopolimero.



CAM ARREDI
COSMOB

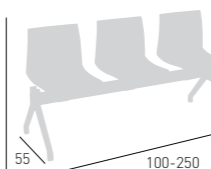

NA not assembled / non assemblato



0,26 m³ - 18 kg.
1 pcs (carton)

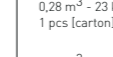

0,28 m³ - 23 kg.
1 pcs (carton)

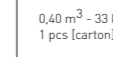

0,38 m³ - 28 kg.
1 pcs (carton)



0,40 m³ - 33 kg.
1 pcs (carton)

Frame Finishing & Codes / Finiture Telai e Codici

cod. 360.--/PG2P-- (100 cm)

€ 700,00

cod. 360.--/PG3P-- (150 cm)

€ 814,00

cod. 360.--/PG4P-- (200 cm)

€ 924,00

cod. 360.--/PG5P-- (250 cm)

€ 1.036,00

Bench legs available colors: 00-06-10-13-14-33-34-42
It is possible to change a seat with a grey metal top
Colori disponibili gambe panca: 00-06-10-13-14-33-34-42
E' possibile sostituire la seduta con un tavolino grigio in metallo

KANVAS CUSHION / CUSCINO



Upholstered cushion.
Cuscino tappezzato.

Available fabric.
Tessuti disponibili.
E, K, DK, B
COM fabric / Tessuto cliente TC



0,5 kg
Inside chairs boxes
Inseriti nella scatola delle sedie

Frame Finishing & Codes / Finiture Telai e Codici

cod. 317.-- (E)

€ 116,00

cod. 317.-- (K)

€ 116,00

cod. 317.-- (DK)

€ 144,00

cod. 317.-- (B)

€ 134,00

cod. 317.TC COM fabric/tessuto cliente

€ 102,00

Fabric required
Fabbisogno di tessuto
4 pcs: Lin Mtrs 1,0 (h1,40)

COM fabric min. order
Tessuto cliente TC ordine
min. 10pz per codice

Min. order 4pcs
each code
Ordine min 4pz
per codice

KANVAS CONNECTING SYSTEM GANCIO CONNESSIONE



Set linking glides for in-line disposal.
Set piedini con agganci per disporre le sedute in linea.



Inside chairs boxes
Nella scatola delle sedie.

Assembled / assemblato

Frame Finishing & Codes / Finiture Telai e Codici

cod. 1012

€ 20,00

available for models: S
disponibile per versioni: S

KANVAS CHAIRS TROLLEY



Trolley for chairs, chromed metal structure.
Carrello porta sedie, struttura in metallo cromato.

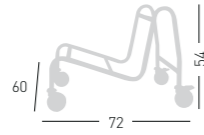

0,3 m³ - 10kg
63x75x58cm.
1 pcs [carton]

Frame Finishing & Codes / Finiture Telai e Codici

cod. 2000/A

€ 242,00

available for models: S
disponibile per versioni: S

stackable on trolley 18 pcs
impilabili su carrello 18 pcs

max height with 18 chairs 178 cm
altezza carrello con 18 sedie 178 cm

KANVAS CHAIRS TROLLEY



Painted grey adjustable Dolly, for 4 legged chairs.
Carrello per sedie 4 gambe, regolabile, verniciato grigio.

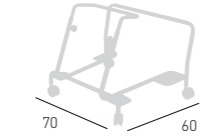

0,3 m³ - 8kg
62x72x51cm.
1 pcs [carton]

Frame Finishing & Codes / Finiture Telai e Codici

cod. 2001/A

€ 290,00

available for models: NA
disponibile per versioni: NA

KANVAS UPHOLSTERED

IMBOTTITE

Available coverings / Finiture disponibili
Aurea eco-leather / Ecopelle aurea **E** (4pcs min.)
King fabric / Tessuto King **K** (4pcs min.)
Blazer fabric / Tessuto Blazer **B** (4pcs min.)
Kvadrat fabrics / Tessuti Kvadrat **DK** (4pcs min.)
COM fabric / Tessuto cliente **TC** (10pcs min.)

KANVAS NA FRONT



Techno-polymer shell front upholstered, chromed, black or white painted frame.
Scocca in tecnopolimero con frontale rivestito e telaio in metallo verniciato nero o bianco o cromato.

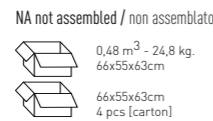
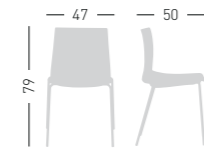

NA not assembled / non assemblato
0,48 m³ - 24,8 kg.
66x55x63cm
4 pcs [carton]

Colours shell / Colori scocca

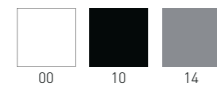

Frame Finishing & Codes / Finiture Telai e Codici

cod. 361._./IENA chromed/cromata

€ 330,00

cod. 361._./IENAN black painted/verniciato nero

€ 366,00

cod. 361._./IENAB white painted/verniciato bianco

€ 366,00

cod. 361._./IKNA chromed/cromata

€ 330,00

cod. 361._./IKNAN black painted/verniciato nero

€ 366,00

cod. 361._./IKNAB white painted/verniciato bianco

€ 366,00

cod. 361._./IBNA chromed/cromata

€ 360,00

cod. 361._./IBNAN black painted/verniciato nero

€ 394,00

cod. 361._./IBNAB white painted/verniciato bianco

€ 394,00

cod. 361._./IDKNA chromed/cromata

€ 420,00

cod. 361._./IDKNAN black painted/verniciato nero

€ 456,00

cod. 361._./IDKNAB white painted/verniciato bianco

€ 456,00

cod. 361._./ITCNA chromed/cromata

€ 304,00

cod. 361._./ITCNAN black painted/verniciato nero

€ 338,00

cod. 361._./ITCNAB white painted/verniciato bianco

€ 338,00

Fabric required

Fabbisogno di tessuto
1 pcs: Lin Mtrs 0,6 (h1,40)

COM fabric min. order
10pcs each code
Tessuto cliente TC ordine
min. 10pz per codice

Min. order 4pcs
each code
Ordine min 4pz
per codice

KANVAS TB FRONT



Techno-polymer shell front upholstered, chromed or painted frame.
Scocca in tecnopolimero con frontale rivestito e telaio in metallo verniciato o cromato.

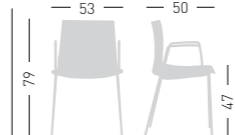

NA not assembled / non assemblato



0,29 m³ - 14,5 kg.
59x53x91cm.
2 pcs [carton]

Colours shell / Colori scocca



Frame Finishing & Codes / Finiture Telai e Codici

cod. 361._./IETB chromed/cromata

€ 368,00

cod. 361._./IETBB white painted/verniciato bianco

€ 414,00

cod. 361._./IKTB chromed/cromata

€ 368,00

cod. 361._./IKTBB white painted/verniciato bianco

€ 414,00

cod. 361._./IBTB chromed/cromata

€ 396,00

cod. 361._./IBTBB white painted/verniciato bianco

€ 440,00

cod. 361._./IDKTB chromed/cromata

€ 458,00

cod. 361._./IDKTB white painted/verniciato bianco

€ 504,00

cod. 361._./ITCTB chromed/cromata

€ 342,00

cod. 361._./ITCTBB white painted/verniciato bianco

€ 382,00

Fabric required

Fabbisogno di tessuto
1 pcs: Lin Mtrs 0,6 (h1,40)

COM fabric min. order
10pcs each code
Tessuto cliente TC ordine
min. 10pz per codice

Min. order 4pcs
each code
Ordine min 4pz
per codice

KANVAS S FRONT



Techno-polymer shell front upholstered, chromed, black or white painted frame.
Scocca in tecnopolimero con frontale rivestito e telaio in metallo cromato, verniciato nero o bianco.

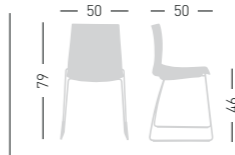

NA not assembled / non assemblato

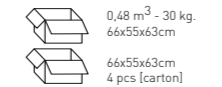

0,48 m³ - 30 kg.
66x55x63cm
4 pcs [carton]

Colours shell / Colori scocca



Frame Finishing & Codes / Finiture Telai e Codici

cod. 361._./IES chromed/cromata

€ 330,00

cod. 361._./IESB white painted/verniciato bianco

€ 366,00

cod. 361._./IESN black painted/verniciato nero

€ 366,00

cod. 361._./IKS chromed/cromata

€ 330,00

cod. 361._./IKSB white painted/verniciato bianco

€ 366,00

cod. 361._./IKSN black painted/verniciato nero

€ 366,00

cod. 361._./IBS chromed/cromata

€ 360,00

cod. 361._./IBSB white painted/verniciato bianco

€ 394,00

cod. 361._./IBSN black painted/verniciato nero

€ 394,00

cod. 361._./IDKS chromed/cromata

€ 420,00

cod. 361._./IDKSB white painted/verniciato bianco

€ 456,00

cod. 361._./IDKSN black painted/verniciato nero

€ 456,00

cod. 361._./ITCS chromed/cromata

€ 304,00

cod. 361._./ITCSB white painted/verniciato bianco

€ 338,00

cod. 361._./ITCSN black painted/verniciato nero

€ 338,00

Fabric required

Fabbisogno di tessuto
1 pcs: Lin Mtrs 0,6 (h1,40)

COM fabric min. order
10pcs each code
Tessuto cliente TC ordine
min. 10pz per codice

Min. order 4pcs
each code
Ordine min 4pz
per codice

KANVAS ST FRONT



Techno-polymer shell front upholstered, chromed or painted frame.
Scocca in tecnopolimero con frontale rivestito e telaio in metallo verniciato o cromato.

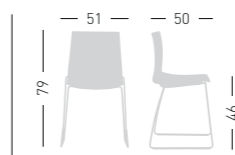

NA not assembled / non assemblato

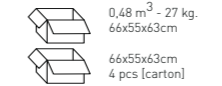

0,48 m³ - 27 kg.
66x55x63cm
4 pcs [carton]

Colours shell / Colori scocca



Frame Finishing & Codes / Finiture Telai e Codici

cod. 361._./IEST chromed/cromata

€ 346,00

cod. 361._./IESTB white painted/verniciato bianco

€ 378,00

cod. 361._./IESTN black painted/verniciato nero

€ 378,00

cod. 361._./IKST chromed/cromata

€ 346,00

cod. 361._./IKSTB white painted/verniciato bianco

€ 378,00

cod. 361._./IKSTN black painted/verniciato nero

€ 378,00

cod. 361._./IBST chromed/cromata

€ 372,00

cod. 361._./IBSTB white painted/verniciato bianco

€ 408,00

cod. 361._./IBSTN black painted/verniciato nero

€ 408,00

cod. 361._./IDKST chromed/cromata

€ 436,00

cod. 361._./IDKSTB white painted/verniciato bianco

€ 468,00

cod. 361._./IDKSTN black painted/verniciato nero

€ 468,00

cod. 361._./ITCST chromed/cromata

€ 316,00

cod. 361._./ITCSTB white painted/verniciato bianco

€ 352,00

cod. 361._./ITCSTN black painted/verniciato nero

€ 352,00

Fabric required

Fabbisogno di tessuto
1 pcs: Lin Mtrs 0,6 (h1,40)

COM fabric min. order
10pcs each code
Tessuto cliente TC ordine
min. 10pz per codice

Min. order 4pcs
each code
Ordine min 4pz
per codice

KANVAS Z FRONT



Chromed "Z" steel frame, techno-polymer shell front upholstered. Struttura in metallo cromato "Z", scocca in tecnopolimero con frontale rivestito.

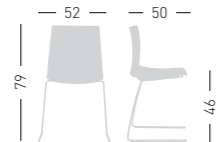

NA not assembled / non assemblato
0,48 m³ - 27 kg.
66x55x63cm
66x55x63cm
4 pcs [carton]

Colours shell / Colori scocca

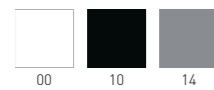

Frame Finishing & Codes / Finiture Telai e Codici

cod. 361. __-__ /IEZ chromed/cromata	€	360,00
cod. 361. __-__ /IKZ chromed/cromata	€	360,00
cod. 361. __-__ /IBZ chromed/cromata	€	388,00
cod. 361. __-__ /IDKZ chromed/cromata	€	452,00
cod. 361. __-__ /ITCZ chromed/cromata	€	330,00

Fabric required
Fabbisogno di tessuto
1 pcs: Lin Mtrs 0,6 (h1,40)

COM fabric min. order
10pcs each code
Tessuto cliente TC ordine
min. 10pz per codice

Min. order 4pcs
each code
Ordine min 4pz
per codice

KANVAS TC FRONT



Techno-polymer shell front upholstered, chromed or painted frame. Scocca in tecnopolimero con frontale rivestito e telaio in metallo verniciato o cromato.

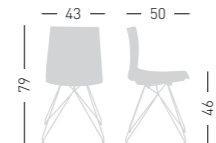

NA not assembled / non assemblato
0,3 m³ - 13,4 kg.
60x56x51cm
48x49x49cm
2 pcs [carton]

Colours shell / Colori scocca



Frame Finishing & Codes / Finiture Telai e Codici

cod. 361. __-__ /IETC chromed/cromata	€	352,00
cod. 361. __-__ /IETCB white painted/verniciato bianco	€	382,00
cod. 361. __-__ /IETCN black painted/verniciato nero	€	382,00
cod. 361. __-__ /IKTC chromed/cromata	€	352,00
cod. 361. __-__ /IKTCB white painted/verniciato bianco	€	382,00
cod. 361. __-__ /IKTCN black painted/verniciato nero	€	382,00
cod. 361. __-__ /IBTC chromed/cromata	€	378,00
cod. 361. __-__ /IBTCB white painted/verniciato bianco	€	414,00
cod. 361. __-__ /IBTCN black painted/verniciato nero	€	414,00
cod. 361. __-__ /IDKTC chromed/cromata	€	442,00
cod. 361. __-__ /IDKTCB white painted/verniciato bianco	€	476,00
cod. 361. __-__ /IDKTCN black painted/verniciato nero	€	476,00
cod. 361. __-__ /ITCTC chromed/cromata	€	322,00
cod. 361. __-__ /ITCTCB white painted/verniciato bianco	€	356,00
cod. 361. __-__ /ITCTCN black painted/verniciato nero	€	356,00

Fabric required
Fabbisogno di tessuto
1 pcs: Lin Mtrs 0,6 (h1,40)

COM fabric min. order
10pcs each code
Tessuto cliente TC ordine
min. 10pz per codice

Min. order 4pcs
each code
Ordine min 4pz
per codice

KANVAS BL FRONT



Techno-polymer shell front upholstered, beech wooden frame. Scocca in tecnopolimero con frontale rivestito e base in legno di faggio.

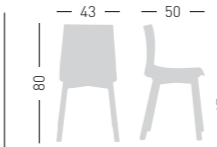

NA not assembled / non assemblato
0,36 m³ - 27,2 kg.
60x56x51cm
60x56x51cm
4 pcs [carton]

Colours shell / Colori scocca



Frame Finishing & Codes / Finiture Telai e Codici

cod. 361. __-__ /IEBLF	€	590,00
cod. 361. __-__ /IKBLF	€	590,00
cod. 361. __-__ /IBBLF	€	646,00
cod. 361. __-__ /IDKBLF	€	682,00
cod. 361. __-__ /ITCBLF	€	564,00

Felt Glides / Tappi in feltro
Fabric required
Fabbisogno di tessuto
1 pcs: Lin Mtrs 0,6 (h1,40)

COM fabric min. order
10pcs each code
Tessuto cliente TC ordine
min. 10pz per codice

Min. order 4pcs
each code
Ordine min 4pz
per codice

KANVAS PG FRONT



Techno-polymer shell front upholstered, frame beam in painted metal and polymer-metal legs. Scocca in tecnopolimero con frontale rivestito, trave panca in metallo verniciato e gambe in polimero-metallo co-iniettati.

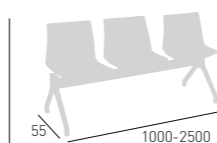

NA not assembled / non assemblato

Colours shell / Colori scocca



Frame Finishing & Codes / Finiture Telai e Codici

(100cm) 0,24 m ³ - 24 kg. 66x55x63cm. 1 pcs [carton]	cod. 361. __-__ /IEPG2P-- (100 cm)	€	1.042,00
(150cm) 0,24 m ³ - 29 kg. 66x55x63cm. 1 pcs [carton]	cod. 361. __-__ /IEPG3P-- (150 cm)	€	1.326,00
(200cm) 0,36 m ³ - 36 kg. 60x56x51x2cm. 1 pcs [carton]	cod. 361. __-__ /IEPG4P-- (200 cm)	€	1.612,00
(250cm) 0,36 m ³ - 43 kg. 60x56x51x2cm. 1 pcs [carton]	cod. 361. __-__ /IEPG5P-- (250 cm)	€	1.894,00
	cod. 361. __-__ /IKPG2P-- (100 cm)	€	1.042,00
	cod. 361. __-__ /IKPG3P-- (150 cm)	€	1.326,00
	cod. 361. __-__ /IKPG4P-- (200 cm)	€	1.612,00
	cod. 361. __-__ /IKPG5P-- (250 cm)	€	1.894,00
	cod. 361. __-__ /IBPG2P-- (100 cm)	€	1.098,00
	cod. 361. __-__ /IBPG3P-- (150 cm)	€	1.410,00
	cod. 361. __-__ /IBPG4P-- (200 cm)	€	1.722,00
	cod. 361. __-__ /IBPG5P-- (250 cm)	€	2.032,00
	cod. 361. __-__ /IDKP2P-- (100 cm)	€	1.226,00
	cod. 361. __-__ /IDKP3P-- (150 cm)	€	1.598,00
	cod. 361. __-__ /IDKP4P-- (200 cm)	€	1.974,00
	cod. 361. __-__ /IDKP5P-- (250 cm)	€	2.348,00
	cod. 361. __-__ /ITCPG2P-- (100 cm)	€	988,00
	cod. 361. __-__ /ITCPG3P-- (150 cm)	€	1.244,00
	cod. 361. __-__ /ITCPG4P-- (200 cm)	€	1.498,00
	cod. 361. __-__ /ITCPG5P-- (250 cm)	€	1.756,00

Bench legs available colors: 00-06-10-13-14-33-34-42
It is possible to change a seat with a grey metal top
Colori disponibili gambe panca: 00-06-10-13-14-33-34-42
E' possibile sostituire la seduta con un tavolino grigio in metallo

Fabric required
Fabbisogno di tessuto
1 pcs: Lin Mtrs 1 (h1,40)

KANVAS T5R FRONT



Swivel on 5-blade polished aluminum base with castors, height adjustable, techno-polymer shell front upholstered. Girevole su base a 5 razze in alluminio pulito con ruote, regolabile in altezza, scocca in tecnopolimero con frontale rivestito.

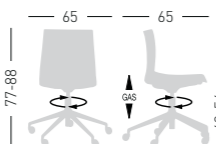

NA not assembled / non assemblato
0,24 m³ - 15,50 kg.
66x56x63cm.
2 pcs [carton]

Colours shell / Colori scocca



Frame Finishing & Codes / Finiture Telai e Codici

cod. 361. __-__ /IET5R polished/pulita	€	588,00
cod. 361. __-__ /IKT5R polished/pulita	€	588,00
cod. 361. __-__ /IBT5R polished/pulita	€	618,00
cod. 361. __-__ /IDKT5R polished/pulita	€	680,00
cod. 361. __-__ /ITCT5R polished/pulita	€	562,00

Fabric required
Fabbisogno di tessuto
1 pcs: Lin Mtrs 0,6 (h1,40)

COM fabric min. order
10pcs each code
Tessuto cliente TC ordine
min. 10pz per codice

Min. order 4pcs
each code
Ordine min 4pz
per codice

KANVAS T5R BR FRONT



Swivel on 5-blade polished aluminum base with castors, height adjustable, techno-polymer shell front upholstered, with armrests. Girevole su base a 5 razze in alluminio pulito con ruote, regolabile in altezza, scocca in tecnopolimero con frontale rivestito e braccioli.

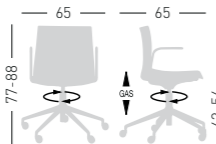

NA not assembled / non assemblato
0,24 m³ - 19 kg.
66x56x63cm.
2 pcs [carton]

Colours shell / Colori scocca



Frame Finishing & Codes / Finiture Telai e Codici

cod. 361. __-__ /IET5RB polished/pulita	€	668,00
cod. 361. __-__ /IKT5RB polished/pulita	€	668,00
cod. 361. __-__ /IBT5RB polished/pulita	€	398,00
cod. 361. __-__ /IDKT5RB polished/pulita	€	760,00
cod. 361. __-__ /ITCT5RB polished/pulita	€	642,00

Fabric required
Fabbisogno di tessuto
1 pcs: Lin Mtrs 0,6 (h1,40)

COM fabric min. order
10pcs each code
Tessuto cliente TC ordine
min. 10pz per codice

Min. order 4pcs
each code
Ordine min 4pz
per codice

KANVAS NA FULL



Techno-polymer upholstered shell and chromed or painted frame.
Scocca in tecnopolimero rivestita e telaio in metallo verniciato o cromato.

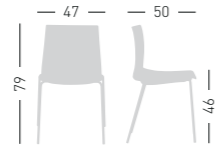

NA not assembled / non assemblato
0,48 m³ - 24,8 kg.
66x55x63cm
66x55x63cm
4 pcs (carton)

Frame Finishing & Codes / Finiture Telai e Codici

cod. 360.--/IENA chromed/cromata	€ 492,00
cod. 360.--/IENAB white painted/verniciato bianco	€ 526,00
cod. 360.--/IENAN black painted/verniciato nero	€ 526,00
cod. 360.--/IKNA chromed/cromata	€ 492,00
cod. 360.--/IKNAB white painted/verniciato bianco	€ 526,00
cod. 360.--/IKNAN black painted/verniciato nero	€ 526,00
cod. 360.--/IBNA chromed/cromata	€ 522,00
cod. 360.--/IBNAB white painted/verniciato bianco	€ 554,00
cod. 360.--/IBNAN black painted/verniciato nero	€ 554,00
cod. 360.--/IDKNA chromed/cromata	€ 642,00
cod. 360.--/IDKNAB white painted/verniciato bianco	€ 674,00
cod. 360.--/IDKNAN black painted/verniciato nero	€ 674,00
cod. 360./ITCNA chromed/cromata	€ 436,00
cod. 360./ITCNAB white painted/verniciato bianco	€ 468,00
cod. 360./ITCNAN black painted/verniciato nero	€ 468,00

Fabric required
Fabbisogno di tessuto
1 pcs: Lin Mtrs 1 (h1,40)

COM fabric min. order
10pcs each code
Tessuto cliente TC ordine
min. 10pz per codice

Min. order 4pcs
each code
Ordine min 4pz
per codice

KANVAS TB FULL



Techno-polymer upholstered shell and chromed or painted frame.
Scocca in tecnopolimero rivestita e telaio in metallo verniciato o cromato.

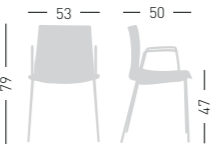

NA not assembled / non assemblato
0,31 m³ - 14,5 kg.
59x53x91cm.
2 pcs (carton)

Frame Finishing & Codes / Finiture Telai e Codici

cod. 360.--/IETB chromed/cromata	€ 528,00
cod. 360.--/IETBB white painted/verniciato bianco	€ 574,00
cod. 360.--/IKTB chromed/cromata	€ 528,00
cod. 360.--/IKTBB white painted/verniciato bianco	€ 574,00
cod. 360.--/IBTB chromed/cromata	€ 556,00
cod. 360.--/IBTBB white painted/verniciato bianco	€ 602,00
cod. 360.--/IDKTB chromed/cromata	€ 676,00
cod. 360.--/IDKTBB white painted/verniciato bianco	€ 722,00
cod. 360./ITCTB chromed/cromata	€ 474,00
cod. 360./ITCTBB white painted/verniciato bianco	€ 514,00

Fabric required
Fabbisogno di tessuto
1 pcs: Lin Mtrs 1 (h1,40)

COM fabric min. order
10pcs each code
Tessuto cliente TC ordine
min. 10pz per codice

Min. order 4pcs
each code
Ordine min 4pz
per codice

KANVAS S FULL



Techno-polymer upholstered shell and chromed or painted frame.
Scocca in tecnopolimero rivestita e telaio in metallo verniciato o cromato.

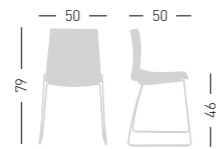

NA not assembled / non assemblato
0,48 m³ - 30 kg.
66x55x63cm
66x55x63cm
4 pcs (carton)

Frame Finishing & Codes / Finiture Telai e Codici

cod. 360.--/IES chromed/cromata	€ 492,00
cod. 360.--/IESB white painted/verniciato bianco	€ 526,00
cod. 360.--/IESN black painted/verniciato nero	€ 526,00
cod. 360.--/IKS chromed/cromata	€ 492,00
cod. 360.--/IKSB white painted/verniciato bianco	€ 526,00
cod. 360.--/IKSN black painted/verniciato nero	€ 526,00
cod. 360.--/IBS chromed/cromata	€ 522,00
cod. 360.--/IBSB white painted/verniciato bianco	€ 554,00
cod. 360.--/IBSN black painted/verniciato nero	€ 554,00
cod. 360.--/IDKS chromed/cromata	€ 642,00
cod. 360.--/IDKSB white painted/verniciato bianco	€ 674,00
cod. 360.--/IDKSN black painted/verniciato nero	€ 674,00
cod. 360./ITCS chromed/cromata	€ 436,00
cod. 360./ITCSB white painted/verniciato bianco	€ 468,00
cod. 360./ITCSN black painted/verniciato nero	€ 468,00

Fabric required
Fabbisogno di tessuto
1 pcs: Lin Mtrs 1 (h1,40)

COM fabric min. order
10pcs each code
Tessuto cliente TC ordine
min. 10pz per codice

Min. order 4pcs
each code
Ordine min 4pz
per codice

KANVAS ST FULL



Techno-polymer upholstered shell and chromed or painted frame.
Scocca in tecnopolimero rivestita e telaio in metallo verniciato o cromato.

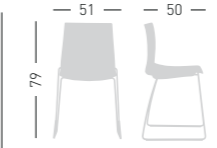

NA not assembled / non assemblato
0,48 m³ - 27 kg.
66x55x63cm
66x55x63cm
4 pcs (carton)

Frame Finishing & Codes / Finiture Telai e Codici

cod. 360.--/IEST chromed/cromata	€ 506,00
cod. 360.--/IESTB white painted/verniciato bianco	€ 540,00
cod. 360.--/IESTN black painted/verniciato nero	€ 540,00
cod. 360.--/IKST chromed/cromata	€ 506,00
cod. 360.--/IKSTB white painted/verniciato bianco	€ 540,00
cod. 360.--/IKSTN black painted/verniciato nero	€ 540,00
cod. 360.--/IBST chromed/cromata	€ 534,00
cod. 360.--/IBSTB white painted/verniciato bianco	€ 566,00
cod. 360.--/IBSTN black painted/verniciato nero	€ 566,00
cod. 360.--/IDKST chromed/cromata	€ 656,00
cod. 360.--/IDKSTB white painted/verniciato bianco	€ 690,00
cod. 360.--/IDKSTN black painted/verniciato nero	€ 690,00
cod. 360./ITCST chromed/cromata	€ 452,00
cod. 360./ITCSTB white painted/verniciato bianco	€ 484,00
cod. 360./ITCSTN black painted/verniciato nero	€ 484,00

Fabric required
Fabbisogno di tessuto
1 pcs: Lin Mtrs 1 (h1,40)

COM fabric min. order
10pcs each code
Tessuto cliente TC ordine
min. 10pz per codice

Min. order 4pcs
each code
Ordine min 4pz
per codice

KANVAS Z FULL



Chromed "Z" steel frame, techno-polymer upholstered shell.
Struttura in metallo cromato "Z", scocca in tecnopolimero rivestito.

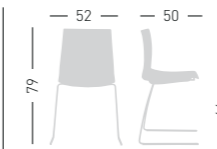

NA not assembled / non assemblato
0,48 m³ - 27 kg.
66x55x63cm
66x55x63cm
4 pcs (carton)

Frame Finishing & Codes / Finiture Telai e Codici

cod. 360.--/IEZ chromed/cromata	€ 322,00
cod. 360.--/IKZ chromed/cromata	€ 322,00
cod. 360.--/IBZ chromed/cromata	€ 550,00
cod. 360.--/IDKZ chromed/cromata	€ 668,00
cod. 360./ITCZ chromed/cromata	€ 462,00

Fabric required
Fabbisogno di tessuto
1 pcs: Lin Mtrs 1 (h1,40)

COM fabric min. order
10pcs each code
Tessuto cliente TC ordine
min. 10pz per codice

Min. order 4pcs
each code
Ordine min 4pz
per codice

KANVAS TC FULL



Techno-polymer upholstered shell and chromed or painted frame.
Scocca in tecnopolimero rivestita e telaio in metallo verniciato o cromato.

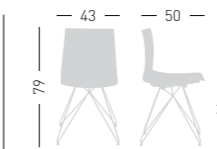

NA not assembled / non assemblato
0,3 m³ - 13,4 kg.
60x56x51cm
48x49x49cm
2 pcs (carton)

Frame Finishing & Codes / Finiture Telai e Codici

cod. 360.--/IETC chromed/cromata	€ 510,00
cod. 360.--/IETCB white painted/verniciato bianco	€ 548,00
cod. 360.--/IETCN black painted/verniciato nero	€ 548,00
cod. 360.--/IKTC chromed/cromata	€ 510,00
cod. 360.--/IKTCB white painted/verniciato bianco	€ 548,00
cod. 360.--/IKTCN black painted/verniciato nero	€ 548,00
cod. 360.--/IBTC chromed/cromata	€ 540,00
cod. 360.--/IBTCB white painted/verniciato bianco	€ 574,00
cod. 360.--/IBTCN black painted/verniciato nero	€ 574,00
cod. 360.--/IDKTC chromed/cromata	€ 660,00
cod. 360.--/IDKTCB white painted/verniciato bianco	€ 696,00
cod. 360.--/IDKTCN black painted/verniciato nero	€ 696,00
cod. 360./ITCTC chromed/cromata	€ 456,00
cod. 360./ITCTCB white painted/verniciato bianco	€ 488,00
cod. 360./ITCTCN black painted/verniciato nero	€ 488,00

Fabric required
Fabbisogno di tessuto
1 pcs: Lin Mtrs 1 (h1,40)

COM fabric min. order
10pcs each code
Tessuto cliente TC ordine
min. 10pz per codice

Min. order 4pcs
each code
Ordine min 4pz
per codice

KANVAS T5R FULL



Swivel on 5-blade polished aluminum base with castors, height adjustable, techno-polymer shell full upholstered.
Girevole su base a 5 razze in alluminio pulito con ruote, regolabile in altezza, scocca in tecnopolimero rivestita.

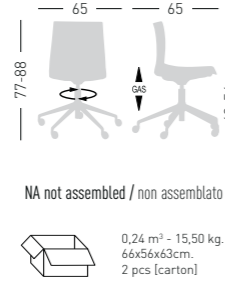

NA not assembled / non assemblato

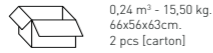

0,24 m³ - 15,50 kg.
66x56x63cm.
2 pcs [carton]

Frame Finishing & Codes / Finiture Telai e Codici

cod. 360.____/IET5R polished/pulita
cod. 360.____/IKT5R polished/pulita
cod. 360.____/IBT5R polished/pulita
cod. 360.____/IDKT5R polished/pulita
cod. 360./ITCT5R polished/pulita

€ 750,00
€ 750,00
€ 776,00
€ 900,00
€ 696,00

Fabric required
Fabbisogno di tessuto
1 pcs: Lin Mtrs 1 (h1,40)

COM fabric min. order
10pcs each code
Tessuto cliente TC ordine
min. 10pz per codice

Min. order 4pcs
each code
Ordine min 4pz
per codice

KANVAS T5R BR FULL



Swivel on 5-blade polished aluminum base with castors, height adjustable, techno-polymer shell full upholstered, with armrests.
Girevole su base a 5 razze in alluminio pulito con ruote, regolabile in altezza, scocca in tecnopolimero rivestita e braccioli.

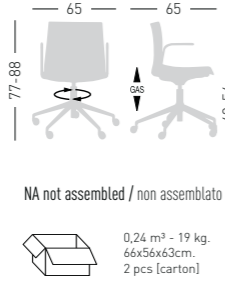

NA not assembled / non assemblato

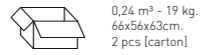

0,24 m³ - 19 kg.
66x56x63cm.
2 pcs [carton]

Frame Finishing & Codes / Finiture Telai e Codici

cod. 360.____/IET5RB polished/pulita
cod. 360.____/IKT5RB polished/pulita
cod. 360.____/IBT5RB polished/pulita
cod. 360.____/IDKT5RB polished/pulita
cod. 360./ITCT5RB polished/pulita

€ 830,00
€ 830,00
€ 856,00
€ 982,00
€ 774,00

Fabric required
Fabbisogno di tessuto
1 pcs: Lin Mtrs 1 (h1,40)

COM fabric min. order
10pcs each code
Tessuto cliente TC ordine
min. 10pz per codice

Min. order 4pcs
each code
Ordine min 4pz
per codice

Armrests available colors
Colori per braccioli disponibili
00-06-10-14-51-54

KANVAS BL FULL



Techno-polymer upholstered shell and beech wood frame.
Scocca in tecnopolimero rivestita e base in legno di faggio.



NA not assembled / non assemblato

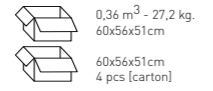

0,36 m³ - 27,2 kg.
60x56x51cm
4 pcs [carton]

Frame Finishing & Codes / Finiture Telai e Codici

cod. 360.--/IEBLF
cod. 360.--/IKBLF
cod. 360.--/IBBLF
cod. 360.--/IDKBLF
cod. 360./ITCBLF

€ 750,00
€ 750,00
€ 776,00
€ 900,00
€ 696,00

Felt Glides / Tappi in feltro
Fabric required
Fabbisogno di tessuto
1 pcs: Lin Mtrs 1 (h1,40)

COM fabric min. order
10pcs each code
Tessuto cliente TC ordine
min. 10pz per codice

Min. order 4pcs
each code
Ordine min 4pz
per codice

F

KANVAS PG FULL



Techno-polymer upholstered shell, frame beam in painted metal and techno-polymer legs.
Scocca rivestita, trave panca in metallo verniciato e gambe in polimero-metallo co-iniettati.

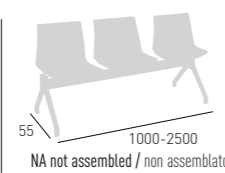

NA not assembled / non assemblato

Frame Finishing & Codes / Finiture Telai e Codici

(100cm)
0,24 m³ - 24 kg.
66x55x63cm.
1 pcs [carton]
(150cm)
0,24 m³ - 29 kg.
66x55x63cm.
1 pcs [carton]
(200cm)
0,36 m³ - 36 kg.
60x56x51x2cm.
1 pcs [carton]
(250cm)
0,36 m³ - 43 kg.
60x56x51x2cm.
1 pcs [carton]

cod. 360.--/IEPG2P-- (100 cm) € 1.362,00
cod. 360.--/IEPG3P-- (150 cm) € 1.808,00
cod. 360.--/IEPG4P-- (200 cm) € 2.252,00
cod. 360.--/IEPG5P-- (250 cm) € 2.696,00
cod. 360.--/IKPG2P-- (100 cm) € 1.362,00
cod. 360.--/IKPG3P-- (150 cm) € 1.808,00
cod. 360.--/IKPG4P-- (200 cm) € 2.252,00
cod. 360.--/IKPG5P-- (250 cm) € 2.696,00
cod. 360.--/IBPG2P-- (100 cm) € 1.420,00
cod. 360.--/IBPG3P-- (150 cm) € 1.892,00
cod. 360.--/IBPG4P-- (200 cm) € 2.366,00
cod. 360.--/IBPG5P-- (250 cm) € 2.838,00
cod. 360.--/IDKP2P-- (100 cm) € 1.662,00
cod. 360.--/IDKP3P-- (150 cm) € 2.256,00
cod. 360.--/IDKP4P-- (200 cm) € 2.850,00
cod. 360.--/IDKP5P-- (250 cm) € 3.440,00
cod. 360./ITCPG2P-- (100 cm) € 1.252,00
cod. 360./ITCPG3P-- (150 cm) € 1.642,00
cod. 360./ITCPG4P-- (200 cm) € 2.028,00
cod. 360./ITCPG5P-- (250 cm) € 2.418,00

Bench legs available colors: 00-06-10-13-14-33-34-42
It is possible to change a seat with a grey metal top
Colori disponibili gambe panca: 00-06-10-13-14-33-34-42
E' possibile sostituire la seduta con un tavolino grigio in metallo

Fabric required
Fabbisogno di tessuto
1 pcs: Lin Mtrs 1 (h1,40)

Kanvas 2



Available colors / Colori disponibili

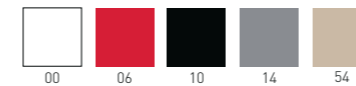

IGN Versions follows UNI 9177 certification in terms of
Fire Resistance, Fire Reaction Class 1
Versioni IGN prodotto Omologato con Classe di Reazione al
fuoco 1, UNI 9177



KANVAS 2 NA



Chromed or white painted 4-Legged metal frame, techno-polymer shell.
Struttura in metallo 4 gambe, cromata o verniciata bianca, scocca in tecnopolimero.



only for paintend frames
solo per telai verniciati

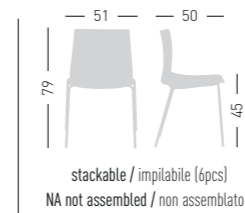

stackable / impilabile (6pcs)
NA not assembled / non assemblato

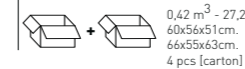

0,42 m³ - 27,2 kg.
60x56x51cm.
66x55x63cm.
4 pcs [carton]

Frame Finishing & Codes / Finiture Telai e Codici

cod. 365.____/NA chromed/cromata
cod. 365.____/NAB white painted/verniciato bianco

€ 192,00
€ 222,00

cod. 365.____/IGNNA
chromed frame, fire retardant/
telaio cromato, ignifuga
Minimum order 300pcs/ Ordine minimo 300pz

€ 260,00

KANVAS 2 ST



Chromed or white painted sled steel frame, techno-polymer shell.
Struttura a slitta, cromata o verniciata bianca, scocca in tecnopolimero.



only for paintend frames
solo per telai verniciati

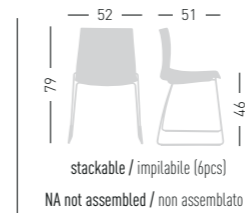

stackable / impilabile (6pcs)
NA not assembled / non assemblato

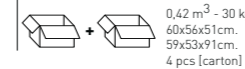

0,42 m³ - 30 kg.
60x56x51cm.
59x53x91cm.
4 pcs [carton]

Frame Finishing & Codes / Finiture Telai e Codici

cod. 365.____/ST chromed/cromata
cod. 365.____/STB white painted/verniciato bianco

€ 206,00
€ 240,00

KANVAS 2 STS



Chromed or white painted sled frame with armrests, techno-polymer shell. Struttura a slitta con braccioli, cromata o verniciata bianca, scocca in tecnopolimero.



only for paintend frames
solo per telai verniciati

Armrests and shell's colours are combined.
Il colore dei braccioli è abbinato alla scocca.

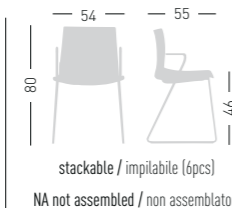

stackable / impilabile (6pcs)
NA not assembled / non assemblato

0,56 m³ - 32 kg.
60x56x51cm.
57x63x97cm.
4 pcs [carton]

Frame Finishing & Codes / Finiture Telai e Codici

cod. 365.____/STS chromed/cromata
cod. 365.____/STSB white painted/verniciato bianco

€ 260,00
€ 292,00

KANVAS 2 CTLS



Chromed or white painted cantilevered frame with armrests, techno-polymer shell. Struttura a slitta con braccioli, cromata o verniciata bianca, scocca in tecnopolimero.



only for paintend frames
solo per telai verniciati

Armrests and shell's colours are combined.
Il colore dei braccioli è abbinato alla scocca.

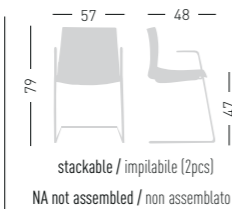

stackable / impilabile (2pcs)
NA not assembled / non assemblato

0,56 m³ - 40 kg.
60x56x51cm.
57x63x97cm.
4 pcs [carton]

Frame Finishing & Codes / Finiture Telai e Codici

cod. 365.____/CTLS chromed/cromata
cod. 365.____/CTLSB white painted/verniciato bianco

€ 264,00
€ 298,00

KANVAS 2 BL



4-Legged wooden beech frame, techno-polymer shell. Struttura in legno di faggio 4 gambe, scocca in tecnopolimero.



F

4-Legged wooden beech frame, techno-polymer shell. Struttura in legno di faggio 4 gambe, scocca in tecnopolimero.

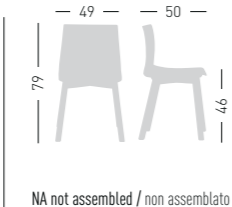

NA not assembled / non assemblato

0,36 m³ - 36 kg.
60x56x51cm.
60x56x51cm.
4 pcs [carton]

Frame Finishing & Codes / Finiture Telai e Codici

cod. 365.____/BLF
Felt Glides / Tappi in feltro

€ 454,00

KANVAS 2 T5R



Swivel on 5-blade polished aluminum base with castors, height adjustable, techno-polymer shell. Girevole su basamento 5 razze in alluminio pulito con ruote, regolabile in altezza, scocca in tecnopolimero.

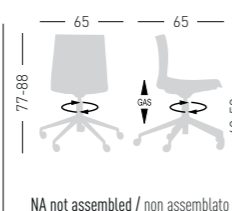

NA not assembled / non assemblato

0,24 m³ - 17 kg.
66x55x63cm.
2 pcs [carton]

Frame Finishing & Codes / Finiture Telai e Codici

cod. 365.____/T5R polished/pulita

€ 484,00

KANVAS 2 T5R BR



Swivel on 5-blade polished aluminum base with castors, height adjustable, techno-polymer shell, armrests. Girevole su basamento 5 razze in alluminio pulito con ruote, regolabile in altezza, scocca in tecnopolimero, braccioli.

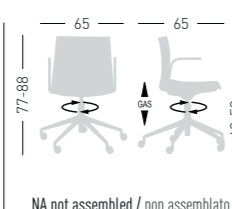

NA not assembled / non assemblato

0,24 m³ - 20 kg.
66x55x63cm.
2 pcs [carton]

Frame Finishing & Codes / Finiture Telai e Codici

cod. 365.____/T5RB polished/pulita

€ 484,00

Armrests and shell's colours are combined.
Il colore dei braccioli è abbinato alla scocca.

KANVAS 2 U



Techno-polymer shell, swivel on 4-blade aluminum painted base. Scocca in tecnopolimero, girevole su basamento verniciato in alluminio a 4 razze.

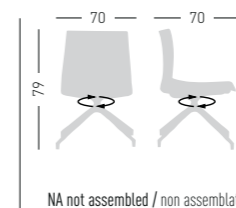

NA not assembled / non assemblato

0,54 m³ - 37 kg.
60x56x51cm.
60x56x51cm.
4 pcs [carton]

Frame Finishing & Codes / Finiture Telai e Codici

cod. 365.____/UB white/bianca
cod. 365.____/UN black/nera

€ 418,00
€ 418,00

Felt Glides / Tappi in feltro

KANVAS 2 U BR



Techno-polymer shell, swivel on 4-blade aluminum painted base, armrests. Scocca in tecnopolimero, girevole su basamento verniciato in alluminio a 4 razze, braccioli.

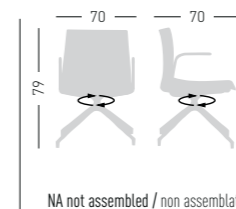

NA not assembled / non assemblato

0,60 m³ - 44 kg.
66x55x63cm.
60x56x51cm.
4 pcs [carton]

Frame Finishing & Codes / Finiture Telai e Codici

cod. 365.____/UBB white/bianca
cod. 365.____/UNB black/nera

€ 500,00
€ 500,00

Felt Glides / Tappi in feltro

Armrests and shell's colours are combined.
Il colore dei braccioli è abbinato alla scocca.

KANVAS 2 UR



Techno-polymer shell, swivel on 4-blade aluminum painted base, with castors. Scocca in tecnopolimero, girevole su basamento verniciato in alluminio a 4 razze, su ruote.

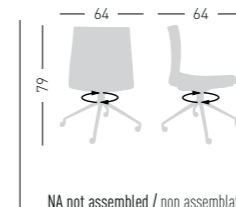

NA not assembled / non assemblato

0,48 m³ - 37 kg.
60x56x51cm.
62x57x42cm.
4 pcs [carton]

Frame Finishing & Codes / Finiture Telai e Codici

cod. 365.____/URB white/bianca
cod. 365.____/URN black/nera

€ 432,00
€ 432,00

KANVAS 2 UR BR



Techno-polymer shell, swivel on 4-blade aluminum painted base, with castors and armrests. Scocca in tecnopolimero, girevole su basamento verniciato in alluminio a 4 razze su ruote, braccioli.

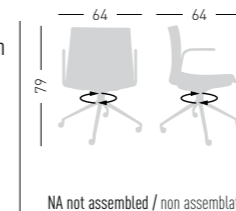

NA not assembled / non assemblato

0,54 m³ - 44 kg.
66x55x63cm.
62x57x42cm.
4 pcs [carton]

Frame Finishing & Codes / Finiture Telai e Codici

cod. 365.____/URBB white/bianca
cod. 365.____/URNB black/nera

€ 510,00
€ 510,00

Armrests and shell's colours are combined.
Il colore dei braccioli è abbinato alla scocca.

KANVAS 2 O5R COACH



Swivel on 5-blade painted or polished aluminum base with castors, height adjustable, technopolymer shell, rotating tablet. Girevole su basamento 5 razze in alluminio verniciato o pulito con ruote, regolabile in altezza, scocca in tecnopolimero, tavoletta rotante.

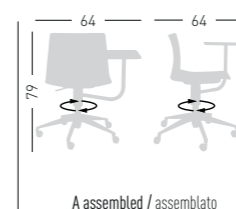

A assembled / assemblato

0,71 m³ - 18 kg.
83x90x95cm.
1 pcs [carton]

Frame Finishing & Codes / Finiture Telai e Codici

cod. 365.____/CO5R polished/pulita
cod. 365.____/CO5RN black painted/verniciata nera

€ 1.118,00
€ 1.104,00

KANVAS 2 CUSHION / CUSCINO



Upholstered cushion.
Cuscino tappezzato.

Available fabric.
Tessuti disponibili.
E, K, B, DK
COM fabric / Tessuto cliente **TC**
(10pcs min.)



0,6 kg
Inside chairs boxes
Inseriti nella
scatola delle sedie

Frame Finishing & Codes / Finiture Telai e Codici

cod. 318.-- (E)
cod. 318.-- (K)
cod. 318.-- (B)
cod. 318.-- (DK)
cod. 318.TC COM fabric/tessuto cliente

€ **138,00**
€ **138,00**
€ **154,00**
€ **166,00**
€ **124,00**

Fabric required
Fabbisogno di tessuto
4 pcs: Lin Mtrs 1,0 (h1,40)

COM fabric min. order
10pcs each code
Tessuto cliente TC ordine
min. 10pz per codice

Min. order 4pcs
each code
Ordine min 4pz
per codice

KANVAS 2 CHAIRS TROLLEY CARRELLO PER SEDIE



Painted grey adjustable Dolly, for 4 legged chairs.
Carrello per sedie 4 gambe, regolabile, verniciato grigio.

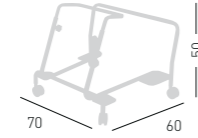

Frame Finishing & Codes / Finiture Telai e Codici

cod. 2001/A

available for models: NA
disponibile per versioni: NA

€ **290,00**



0,3 m³ - 8kg
62x72x51cm.
1 pcs (carton)

Painted grey adjustable Dolly, for 4 legged chairs.
Carrello per sedie 4 gambe, regolabile, verniciato grigio.

KANVAS 2 UPHOLSTERED IMBOTTITE

Available coverings / Finiture disponibili
Aurea eco-leather / Ecopelle aurea **E** (4pcs min.)
King fabric / Tessuto King **K** (4pcs min.)
Blazer fabric / Tessuto Blazer **B** (4pcs min.)
Kvadrat fabrics / Tessuti Kvadrat **DK** (4pcs min.)
COM fabric / Tessuto cliente **TC** (10pcs min.)

KANVAS 2 NA FRONT



Techno-polymer shell front upholstered, chromed or painted frame.
Scocca in tecnopolimero con frontale rivestito e telaio in metallo verniciato o cromato.

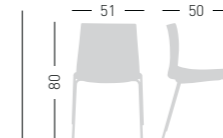

NA not assembled / non assemblato

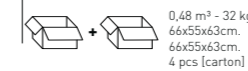

0,48 m³ - 32 kg.
66x55x63cm.
66x55x63cm.
4 pcs (carton)

Colours shell / Colori scocca

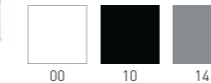

Frame Finishing & Codes / Finiture Telai e Codici

cod. 366.-- /IENA chromed/cromata € **410,00**
cod. 366.-- /IENAB white painted/verniciato bianco € **442,00**
cod. 366.-- /IKNA chromed/cromata € **410,00**
cod. 366.-- /IKNAB white painted/verniciato bianco € **442,00**
cod. 366.-- /IBNA chromed/cromata € **252,00**
cod. 366.-- /IBNAB white painted/verniciato bianco € **482,00**
cod. 366.-- /IDKNA chromed/cromata € **558,00**
cod. 366.-- /IDKNAB white painted/verniciato bianco € **590,00**
cod. 366.-- /ITCNA chromed/cromata € **382,00**
cod. 366.-- /ITCNAB white painted/verniciato bianco € **416,00**

Fabric required
Fabbisogno di tessuto
1 pcs: Lin Mtrs 0,7 (h1,40)

COM fabric min. order
10pcs each code
Tessuto cliente TC ordine
min. 10pz per codice

Min. order 4pcs
each code
Ordine min 4pz
per codice

KANVAS 2 ST FRONT



Techno-polymer shell front upholstered, chromed or painted frame.
Scocca in tecnopolimero con frontale rivestito e telaio in metallo verniciato o cromato.

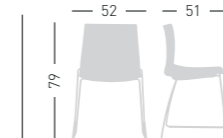

NA not assembled / non assemblato

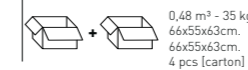

0,48 m³ - 35 kg.
66x55x63cm.
66x55x63cm.
4 pcs (carton)

Colours shell / Colori scocca



Frame Finishing & Codes / Finiture Telai e Codici

cod. 366.-- /IEST chromed/cromata € **424,00**
cod. 366.-- /IESTB white painted/verniciato bianco € **458,00**
cod. 366.-- /IKST chromed/cromata € **424,00**
cod. 366.-- /IKSTB white painted/verniciato bianco € **458,00**
cod. 366.-- /IBST chromed/cromata € **462,00**
cod. 366.-- /IBSTB white painted/verniciato bianco € **500,00**
cod. 366.-- /IDKST chromed/cromata € **574,00**
cod. 366.-- /IDKSTB white painted/verniciato bianco € **608,00**
cod. 366.-- /ITCST chromed/cromata € **396,00**
cod. 366.-- /ITCSTB white painted/verniciato bianco € **432,00**

Fabric required
Fabbisogno di tessuto
1 pcs: Lin Mtrs 0,7 (h1,40)

COM fabric min. order
10pcs each code
Tessuto cliente TC ordine
min. 10pz per codice

Min. order 4pcs
each code
Ordine min 4pz
per codice

KANVAS 2 STS FRONT



Chromed or white painted sled frame with armrests, front upholstered shell.
Struttura a slitta con braccioli, cromata o verniciata bianca, scocca rivestita front.

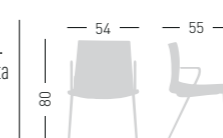

NA not assembled / non assemblato

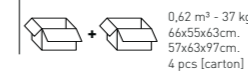

0,62 m³ - 37 kg.
66x55x63cm.
57x63x97cm.
4 pcs (carton)

Armrests and shell's colours are combined.
Il colore dei braccioli è abbinato alla scocca.

Colours shell / Colori scocca



Frame Finishing & Codes / Finiture Telai e Codici

cod. 366.-- /IESTS chromed/cromata € **478,00**
cod. 366.-- /IESTSB white painted/verniciato bianco € **508,00**
cod. 366.-- /IKSTS chromed/cromata € **478,00**
cod. 366.-- /IKSTSB white painted/verniciato bianco € **508,00**
cod. 366.-- /IBSTS chromed/cromata € **514,00**
cod. 366.-- /IBSTSB white painted/verniciato bianco € **550,00**
cod. 366.-- /IDKSTS chromed/cromata € **628,00**
cod. 366.-- /IDKSTSB white painted/verniciato bianco € **658,00**
cod. 366.-- /ITCSTS chromed/cromata € **452,00**
cod. 366.-- /ITCSTSB white painted/verniciato bianco € **482,00**

Fabric required
Fabbisogno di tessuto
1 pcs: Lin Mtrs 0,7 (h1,40)

COM fabric min. order
10pcs each code
Tessuto cliente TC ordine
min. 10pz per codice

Min. order 4pcs
each code
Ordine min 4pz
per codice

KANVAS 2 CTLS FRONT



Chromed or white painted cantilevered metal frame, front upholstered shell.
Struttura in metallo cantilever, cromata o verniciata bianca, scocca rivestita front.

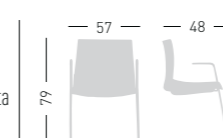

NA not assembled / non assemblato

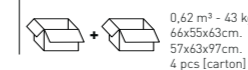

0,62 m³ - 43 kg.
66x55x63cm.
57x63x97cm.
4 pcs (carton)

Armrests and shell's colours are combined.
Il colore dei braccioli è abbinato alla scocca.

Colours shell / Colori scocca



Frame Finishing & Codes / Finiture Telai e Codici

cod. 366.-- /IECTLS chromed/cromata € **482,00**
cod. 366.-- /IECTLSB white painted/verniciato bianco € **512,00**
cod. 366.-- /IKCTLS chromed/cromata € **482,00**
cod. 366.-- /IKCTLSB white painted/verniciato bianco € **512,00**
cod. 366.-- /IBCTLS chromed/cromata € **524,00**
cod. 366.-- /IBCTLSB white painted/verniciato bianco € **554,00**
cod. 366.-- /IDKCTLS chromed/cromata € **632,00**
cod. 366.-- /IDKCTLSB white painted/verniciato bianco € **662,00**
cod. 366.-- /ITCCTLS chromed/cromata € **456,00**
cod. 366.-- /ITCCTLSB white painted/verniciato bianco € **486,00**

Fabric required
Fabbisogno di tessuto
1 pcs: Lin Mtrs 0,7 (h1,40)

COM fabric min. order
10pcs each code
Tessuto cliente TC ordine
min. 10pz per codice

Min. order 4pcs
each code
Ordine min 4pz
per codice

KANVAS 2 BL FRONT



Techno-polymer shell front upholstered, beech wooden frame. Scocca in tecnopolimero con frontale rivestito e base in legno di faggio.

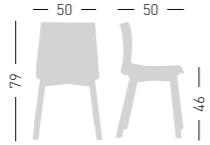

NA not assembled / non assemblato



Colours shell / Colori scocca

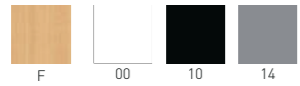

Frame Finishing & Codes / Finiture Tetai e Codici

cod. 366. __ / IEBLF	€ 672,00
cod. 366. __ / IKBLF	€ 672,00
cod. 366. __ / IBBLF	€ 740,00
cod. 366. __ / IDKBLF	€ 820,00
cod. 366. __ / ITCBLF E	€ 570,00

Felt Glides / Tappi in feltro

Fabric required
Fabbisogno di tessuto
1 pcs: Lin Mtrs 0,7 (h1,40)

COM fabric min. order
10pcs each code
Tessuto cliente TC ordine
min. 10pz per codice

Min. order 4pcs
each code
Ordine min 4pz
per codice

KANVAS 2 T5R FRONT



Swivel on 5-blade polished aluminum base with castors, height adjustable, techno-polymer shell front upholstered.

Girevole su base a 5 razze in alluminio pulito con ruote, regolabile in altezza, scocca in tecnopolimero con frontale rivestito.

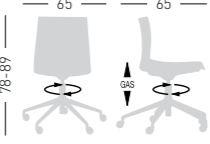

NA not assembled / non assemblato



Colours shell / Colori scocca

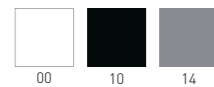

Frame Finishing & Codes / Finiture Tetai e Codici

cod. 366. __ / IET5R polished/pulita	€ 702,00
cod. 366. __ / IKT5R polished/pulita	€ 702,00
cod. 366. __ / IBT5R polished/pulita	€ 744,00
cod. 366. __ / IDKT5R polished/pulita	€ 852,00
cod. 366. __ / ITCT5R polished/pulita	€ 676,00

Fabric required

Fabbisogno di tessuto
1 pcs: Lin Mtrs 0,7 (h1,40)

COM fabric min. order
10pcs each code
Tessuto cliente TC ordine
min. 10pz per codice

Min. order 4pcs
each code
Ordine min 4pz
per codice

KANVAS 2 T5R BR FRONT



Swivel on 5-blade polished aluminum base with castors, height adjustable, techno-polymer shell front upholstered, with armrests.

Girevole su base a 5 razze in alluminio pulito con ruote, regolabile in altezza, scocca in tecnopolimero con frontale rivestito e braccioli.

Armrests and shell's colours are combined. Il colore dei braccioli è abbinato alla scocca.

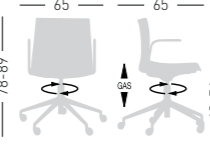

NA not assembled / non assemblato



Colours shell / Colori scocca



Frame Finishing & Codes / Finiture Tetai e Codici

cod. 366. __ / IET5RB polished/pulita	€ 782,00
cod. 366. __ / IKT5RB polished/pulita	€ 782,00
cod. 366. __ / IBT5RB polished/pulita	€ 822,00
cod. 366. __ / IDKT5RB polished/pulita	€ 932,00
cod. 366. __ / ITCT5RB polished/pulita	€ 754,00

Fabric required

Fabbisogno di tessuto
1 pcs: Lin Mtrs 0,7 (h1,40)

COM fabric min. order
10pcs each code
Tessuto cliente TC ordine
min. 10pz per codice

Min. order 4pcs
each code
Ordine min 4pz
per codice

KANVAS 2 U FRONT



Techno-polymer shell, swivel on 4-blade aluminum painted base, front upholstered shell.

Scocca in tecnopolimero, girevole su basamento verniciato in alluminio a 4 razze, scocca rivestita front.

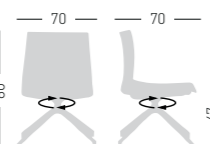

NA not assembled / non assemblato

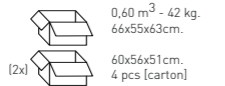

Colours shell / Colori scocca

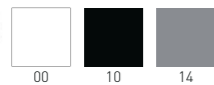

Frame Finishing & Codes / Finiture Tetai e Codici

cod. 366. __ / IKUB white/bianca	€ 636,00
cod. 366. __ / IKUN black/nera	€ 636,00
cod. 366. __ / IKUL polished/lucida	€ 662,00
cod. 366. __ / IEUB white/bianca	€ 636,00
cod. 366. __ / IEUN black/nera	€ 636,00
cod. 366. __ / IEUL polished/lucida	€ 662,00
cod. 366. __ / IBUB white/bianca	€ 662,00
cod. 366. __ / IBUN black/nera	€ 662,00
cod. 366. __ / IBUL polished/lucida	€ 690,00
cod. 366. __ / IDKUB white/bianca	€ 788,00
cod. 366. __ / IDKUN black/nera	€ 788,00
cod. 366. __ / IDKUL polished/lucida	€ 814,00
cod. 366. __ / ITCUB white/bianca	€ 580,00
cod. 366. __ / ITCUN black/nera	€ 580,00
cod. 366. __ / ITCUL polished/lucida	€ 608,00

Felt Glides / Tappi in feltro

Fabric required
Fabbisogno di tessuto
1 pcs: Lin Mtrs 0,7 (h1,40)

COM fabric min. order
10pcs each code
Tessuto cliente TC ordine
min. 10pz per codice

Min. order 4pcs
each code
Ordine min 4pz
per codice

KANVAS 2 U BR FRONT



Techno-polymer shell, swivel on 4-blade aluminum painted base, armrests, front upholstered shell. Scocca in tecnopolimero, girevole su basamento verniciato in alluminio a 4 razze, braccioli, scocca rivestita front.

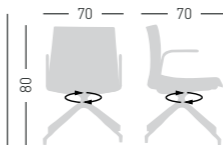

NA not assembled / non assemblato



Colours shell / Colori scocca



Armrests and shell's colours are combined. Il colore dei braccioli è abbinato alla scocca.

Frame Finishing & Codes / Finiture Tetai e Codici

cod. 366. __ / IKUBB white/bianca	€ 718,00
cod. 366. __ / IKUNB black/nera	€ 718,00
cod. 366. __ / IKULB polished/lucida	€ 744,00
cod. 366. __ / IEUBB white/bianca	€ 718,00
cod. 366. __ / IEUNB black/nera	€ 718,00
cod. 366. __ / IEULB polished/lucida	€ 744,00
cod. 366. __ / IBUBB white/bianca	€ 744,00
cod. 366. __ / IBUNB black/nera	€ 744,00
cod. 366. __ / IBULB polished/lucida	€ 770,00
cod. 366. __ / IDKUBB white/bianca	€ 866,00
cod. 366. __ / IDKUNB black/nera	€ 866,00
cod. 366. __ / IDKULB polished/lucida	€ 894,00
cod. 366. __ / ITCUBB white/bianca	€ 660,00
cod. 366. __ / ITCUNB black/nera	€ 660,00
cod. 366. __ / ITCULB polished/lucida	€ 686,00

Felt Glides / Tappi in feltro

Fabric required
Fabbisogno di tessuto
1 pcs: Lin Mtrs 0,7 (h1,40)

COM fabric min. order
10pcs each code
Tessuto cliente TC ordine
min. 10pz per codice

Min. order 4pcs
each code
Ordine min 4pz
per codice

KANVAS 2 UR FRONT



Techno-polymer shell, swivel on 4-blade aluminum painted base, with castors, front upholstered shell. Scocca in tecnopolimero, girevole su basamento verniciato in alluminio a 4 razze, su ruote, scocca rivestita front.

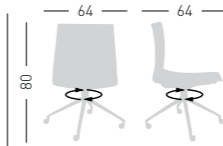

NA not assembled / non assemblato

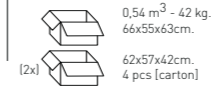

Colours shell / Colori scocca



Frame Finishing & Codes / Finiture Tetai e Codici

cod. 366. __ / IKURB white/bianca	€ 650,00
cod. 366. __ / IKURN black/nera	€ 650,00
cod. 366. __ / IKURL polished/lucida	€ 676,00
cod. 366. __ / IEURB white/bianca	€ 650,00
cod. 366. __ / IEURN black/nera	€ 650,00
cod. 366. __ / IEURL polished/lucida	€ 676,00
cod. 366. __ / IBURB white/bianca	€ 676,00
cod. 366. __ / IBURN black/nera	€ 676,00
cod. 366. __ / IBURL polished/lucida	€ 702,00
cod. 366. __ / IDKURB white/bianca	€ 798,00
cod. 366. __ / IDKURN black/nera	€ 798,00
cod. 366. __ / IDKURL polished/lucida	€ 826,00
cod. 366. __ / ITCURB white/bianca	€ 798,00
cod. 366. __ / ITCURN black/nera	€ 798,00
cod. 366. __ / ITCURL polished/lucida	€ 620,00

Fabric required
Fabbisogno di tessuto
1 pcs: Lin Mtrs 0,7 (h1,40)

COM fabric min. order
10pcs each code
Tessuto cliente TC ordine
min. 10pz per codice

Min. order 4pcs
each code
Ordine min 4pz
per codice

KANVAS 2 UR BR FRONT



Techno-polymer shell, swivel on 4-blade aluminum painted base, with castors and armrests, front upholstered shell. Scocca in tecnopolimero, girevole su basamento verniciato in alluminio a 4 razze su ruote, braccioli, scocca rivestita front.

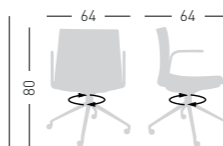

NA not assembled / non assemblato

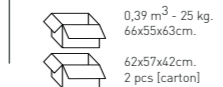

Colours shell / Colori scocca



Armrests and shell's colours are combined. Il colore dei braccioli è abbinato alla scocca.

Frame Finishing & Codes / Finiture Tetai e Codici

cod. 366. __ / IKURBB white/bianca	€ 728,00
cod. 366. __ / IKURNB black/nera	€ 728,00
cod. 366. __ / IKURLB polished/lucida	€ 754,00
cod. 366. __ / IEURBB white/bianca	€ 728,00
cod. 366. __ / IEURNB black/nera	€ 728,00
cod. 366. __ / IEURLB polished/lucida	€ 754,00
cod. 366. __ / IBURBB white/bianca	€ 754,00
cod. 366. __ / IBURNB black/nera	€ 754,00
cod. 366. __ / IBURLB polished/lucida	€ 782,00
cod. 366. __ / IDKURBB white/bianca	€ 878,00
cod. 366. __ / IDKURNB black/nera	€ 878,00
cod. 366. __ / IDKURLB polished/lucida	€ 904,00
cod. 366. __ / ITCURBB white/bianca	€ 674,00
cod. 366. __ / ITCURNB black/nera	€ 674,00
cod. 366. __ / ITCURLB polished/lucida	€ 700,00

Fabric required
Fabbisogno di tessuto
1 pcs: Lin Mtrs 0,7 (h1,40)

COM fabric min. order
10pcs each code
Tessuto cliente TC ordine
min. 10pz per codice

Min. order 4pcs
each code
Ordine min 4pz
per codice

KANVAS 2 05R COACH FRONT



Swivel on 5-blade painted or polished aluminum base with castors, height adjustable, technopolymer shell, rotating tablet, front upholstered shell. Girevole su basamento 5 razze in alluminio verniciato o pulito con ruote, regolabile in altezza, scocca in tecnopolimero, tavoletta rotante, scocca rivestita front.

Colours shell / Colori scocca

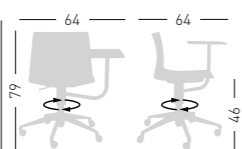
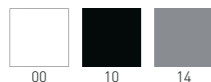

A assembled / assemblato



0,71 m³ - 19 kg.
83x90x95cm.
1 pcs [carton]

Frame Finishing & Codes / Finiture Telai e Codici

cod. 366. __ /IEC05R polished/pulita	€ 1.336,00
cod. 366. __ /IEC05RN black painted/verniciata nera	€ 1.324,00
cod. 366. __ /IKC05R polished/pulita	€ 1.336,00
cod. 366. __ /IKC05RN black painted/verniciata nera	€ 1.324,00
cod. 366. __ /IBC05R polished/pulita	€ 1.378,00
cod. 366. __ /IBC05RN black painted/verniciata nera	€ 1.362,00
cod. 366. __ /IDK05R polished/pulita	€ 1.486,00
cod. 366. __ /IDK05RN black painted/verniciata nera	€ 1.472,00
cod. 366. __ /ITC05R polished/pulita	€ 1.310,00
cod. 366. __ /ITC05RN black painted/verniciata nera	€ 1.298,00

Fabric required
Fabbisogno di tessuto
1 pcs: Lin Mtrs 0,7 (h1,40)

COM fabric min. order
10pcs each code
Tessuto cliente TC ordine
min. 10pz per codice

Min. order 4pcs
each code
Ordine min 4pz
per codice

KANVAS 2 CTLS FULL



Chromed or white painted cantilevered metal frame, full upholstered shell. Struttura in metallo cantilever, cromata o verniciata bianca, scocca rivestita full.

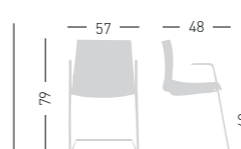

NA not assembled / non assemblato

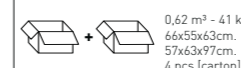

0,62 m³ - 41 kg.
66x55x63cm.
57x63x97cm.
4 pcs [carton]

Frame Finishing & Codes / Finiture Telai e Codici

cod. 365. __ /IECTLS chromed/cromata	€ 658,00
cod. 365. __ /IECTLSB white painted/verniciato bianco	€ 690,00
cod. 365. __ /IKCTLS chromed/cromata	€ 658,00
cod. 365. __ /IKCTLSB white painted/verniciato bianco	€ 690,00
cod. 365. __ /IBCTLS chromed/cromata	€ 710,00
cod. 365. __ /IBCTLSB white painted/verniciato bianco	€ 744,00
cod. 365. __ /IDKCTLS chromed/cromata	€ 840,00
cod. 365. __ /IDKCTLSB white painted/verniciato bianco	€ 872,00
cod. 365. __ /ITCCTLS chromed/cromata	€ 606,00
cod. 365. __ /ITCCTLSB white painted/verniciato bianco	€ 636,00

Fabric required
Fabbisogno di tessuto
1 pcs: Lin Mtrs 1,2 (h1,40)

COM fabric min. order
10pcs each code
Tessuto cliente TC ordine
min. 10pz per codice

Min. order 4pcs
each code
Ordine min 4pz
per codice

KANVAS 2 BL FULL



Techno-polymer upholstered shell and beech wood frame. Scocca in tecnopolimero rivestita e base in legno di faggio.

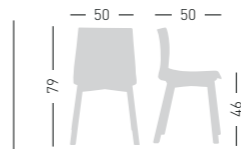

NA not assembled / non assemblato

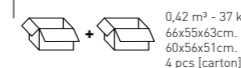

0,42 m³ - 37 kg.
66x55x63cm.
60x56x51cm.
4 pcs [carton]

Frame Finishing & Codes / Finiture Telai e Codici

cod. 365. __ /IEBLF	€ 856,00
cod. 365. __ /IKBLF	€ 856,00
cod. 365. __ /IBBLF	€ 898,00
cod. 365. __ /IDKBLF	€ 1.038,00
cod. 365. __ /ITCBLF	€ 794,00

Felt Glides / Tappi in feltro
Fabric required
Fabbisogno di tessuto
1 pcs: Lin Mtrs 1,2 (h1,40)

COM fabric min. order
10pcs each code
Tessuto cliente TC ordine
min. 10pz per codice

Min. order 4pcs
each code
Ordine min 4pz
per codice

KANVAS 2 NA FULL



Chromed or white painted 4-Legged metal frame, full upholstered shell. Struttura in metallo 4 gambe, cromata o verniciata bianca, scocca rivestita full.

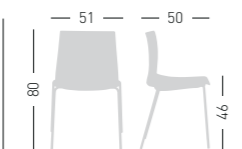

NA not assembled / non assemblato



0,48 m³ - 28 kg.
66x55x63cm.
66x55x63cm.
4 pcs [carton]

Frame Finishing & Codes / Finiture Telai e Codici

cod. 365. __ /IENA chromed/cromata	€ 586,00
cod. 365. __ /IENAB white painted/verniciato bianco	€ 618,00
cod. 365. __ /IKNA chromed/cromata	€ 586,00
cod. 365. __ /IKNAB white painted/verniciato bianco	€ 618,00
cod. 365. __ /IBNA chromed/cromata	€ 638,00
cod. 365. __ /IBNAB white painted/verniciato bianco	€ 672,00
cod. 365. __ /IDKNA chromed/cromata	€ 768,00
cod. 365. __ /IDKNAB white painted/verniciato bianco	€ 798,00
cod. 365. __ /ITCNA chromed/cromata	€ 532,00
cod. 365. __ /ITCNAB white painted/verniciato bianco	€ 564,00

Fabric required
Fabbisogno di tessuto
1 pcs: Lin Mtrs 1,2 (h1,40)

COM fabric min. order
10pcs each code
Tessuto cliente TC ordine
min. 10pz per codice

Min. order 4pcs
each code
Ordine min 4pz
per codice

KANVAS 2 T5R FULL



Swivel on 5-blade polished aluminum base with castors, height adjustable, techno-polymer shell full upholstered. Girevole su base a 5 razze in alluminio pulito con ruote, regolabile in altezza, scocca in tecnopolimero rivestita.

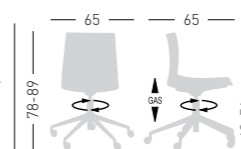

NA not assembled / non assemblato



0,24 m³ - 19 kg.
66x55x63cm.
2 pcs [carton]

Frame Finishing & Codes / Finiture Telai e Codici

cod. 365. __ /IET5R polished/pulita	€ 878,00
cod. 365. __ /IKT5R polished/pulita	€ 878,00
cod. 365. __ /IBT5R polished/pulita	€ 920,00
cod. 365. __ /IDKT5R polished/pulita	€ 1.060,00
cod. 365. __ /ITCT5R polished/pulita	€ 826,00

Fabric required
Fabbisogno di tessuto
1 pcs: Lin Mtrs 1,2 (h1,40)

COM fabric min. order
10pcs each code
Tessuto cliente TC ordine
min. 10pz per codice

Min. order 4pcs
each code
Ordine min 4pz
per codice

KANVAS 2 ST FULL



Chromed or white painted sled steel frame, full upholstered shell. Struttura a slitta, cromata o verniciata bianca, scocca rivestita full.

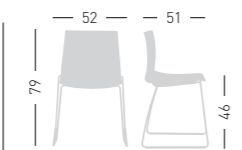

NA not assembled / non assemblato



0,48 m³ - 31 kg.
66x55x63cm.
66x55x63cm.
4 pcs [carton]

Frame Finishing & Codes / Finiture Telai e Codici

cod. 365. __ /IEST chromed/cromata	€ 600,00
cod. 365. __ /IESTB white painted/verniciato bianco	€ 632,00
cod. 365. __ /IKST chromed/cromata	€ 600,00
cod. 365. __ /IKSTB white painted/verniciato bianco	€ 632,00
cod. 365. __ /IBST chromed/cromata	€ 654,00
cod. 365. __ /IBSTB white painted/verniciato bianco	€ 686,00
cod. 365. __ /IDKST chromed/cromata	€ 778,00
cod. 365. __ /IDKSTB white painted/verniciato bianco	€ 814,00
cod. 365. __ /ITCST chromed/cromata	€ 548,00
cod. 365. __ /ITCSTB white painted/verniciato bianco	€ 580,00

Fabric required
Fabbisogno di tessuto
1 pcs: Lin Mtrs 1,2 (h1,40)

COM fabric min. order
10pcs each code
Tessuto cliente TC ordine
min. 10pz per codice

Min. order 4pcs
each code
Ordine min 4pz
per codice

KANVAS 2 T5R BR FULL



Swivel on 5-blade polished aluminum base with castors, height adjustable, techno-polymer shell full upholstered, with armrests. Girevole su base a 5 razze in alluminio pulito con ruote, regolabile in altezza, scocca in tecnopolimero rivestita e braccioli.

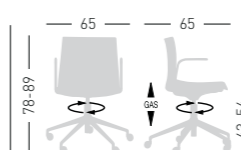

NA not assembled / non assemblato



0,24 m³ - 19 kg.
66x55x63cm.
2 pcs [carton]

Frame Finishing & Codes / Finiture Telai e Codici

cod. 365. __ /IET5RB polished/pulita	€ 960,00
cod. 365. __ /IKT5RB polished/pulita	€ 960,00
cod. 365. __ /IBT5RB polished/pulita	€ 998,00
cod. 365. __ /IDKT5RB polished/pulita	€ 1.140,00
cod. 365. __ /ITCT5RB polished/pulita	€ 904,00

Fabric required
Fabbisogno di tessuto
1 pcs: Lin Mtrs 1,2 (h1,40)

COM fabric min. order
10pcs each code
Tessuto cliente TC ordine
min. 10pz per codice

Min. order 4pcs
each code
Ordine min 4pz
per codice

KANVAS 2 STS FULL



Chromed or white painted sled frame with armrests, full upholstered shell. Struttura a slitta con braccioli, cromata o verniciata bianca, scocca rivestita full.

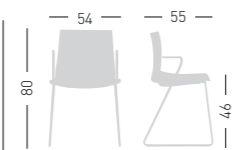

NA not assembled / non assemblato



0,62 m³ - 33 kg.
66x55x63cm.
57x63x97cm.
4 pcs [carton]

Frame Finishing & Codes / Finiture Telai e Codici

cod. 365. __ /IESTS chromed/cromata	€ 654,00
cod. 365. __ /IESTSB white painted/verniciato bianco	€ 686,00
cod. 365. __ /IKSTS chromed/cromata	€ 654,00
cod. 365. __ /IKSTSB white painted/verniciato bianco	€ 686,00
cod. 365. __ /IBSTS chromed/cromata	€ 706,00
cod. 365. __ /IBSTSB white painted/verniciato bianco	€ 740,00
cod. 365. __ /IDKSTS chromed/cromata	€ 832,00
cod. 365. __ /IDKSTSB white painted/verniciato bianco	€ 870,00
cod. 365. __ /ITCSTS chromed/cromata	€ 600,00
cod. 365. __ /ITCSTSB white painted/verniciato bianco	€ 632,00

Fabric required
Fabbisogno di tessuto
1 pcs: Lin Mtrs 1,2 (h1,40)

COM fabric min. order
10pcs each code
Tessuto cliente TC ordine
min. 10pz per codice

Min. order 4pcs
each code
Ordine min 4pz
per codice

Armrests available colors
Colori per braccioli disponibili
00-06-10-14-51-54

KANVAS 2 U FULL



Techno-polymer shell, swivel on 4-blade aluminum painted base, full upholstered shell.
Scocca in tecnopolimero, girevole su basamento verniciato in alluminio a 4 razze, scocca rivestita full.

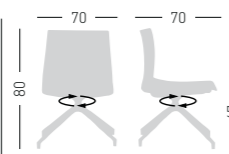

NA not assembled / non assemblato

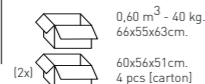

Frame Finishing & Codes / Finiture Telai e Codici

cod. 365. __/IKUB white/bianca	€ 814,00
cod. 365. __/IKUN black/nera	€ 814,00
cod. 365. __/IKUL polished/lucida	€ 840,00
cod. 365. __/IEUB white/bianca	€ 814,00
cod. 365. __/IEUN black/nera	€ 814,00
cod. 365. __/IEUL polished/lucida	€ 840,00
cod. 365. __/IBUB white/bianca	€ 866,00
cod. 365. __/IBUN black/nera	€ 866,00
cod. 365. __/IBUL polished/lucida	€ 894,00
cod. 365. __/IDKUB white/bianca	€ 992,00
cod. 365. __/IDKUN black/nera	€ 992,00
cod. 365. __/IDKUL polished/lucida	€ 1.018,00
cod. 365./ITCUB white/bianca	€ 760,00
cod. 365./ITCUN black/nera	€ 760,00
cod. 365./ITCUL polished/lucida	€ 788,00

Felt Glides / Tappi in feltro
Fabric required
Fabbisogno di tessuto
1 pcs: Lin Mtrs 1,2 (h1,40)

COM fabric min. order
10pcs each code
Tessuto cliente TC ordine
min. 10pz per codice

Min. order 4pcs
each code
Ordine min 4pz
per codice

KANVAS 2 U BR FULL



Techno-polymer shell, swivel on 4-blade aluminum painted base, armrests, full upholstered shell.
Scocca in tecnopolimero, girevole su basamento verniciato in alluminio a 4 razze, braccioli, scocca rivestita full.

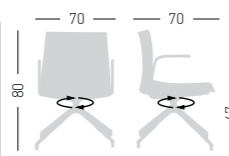

NA not assembled / non assemblato



Frame Finishing & Codes / Finiture Telai e Codici

cod. 365. __/IKUBB white/bianca	€ 894,00
cod. 365. __/IKUNB black/nera	€ 894,00
cod. 365. __/IKULB polished/lucida	€ 920,00
cod. 365. __/IEUBB white/bianca	€ 894,00
cod. 365. __/IEUNB black/nera	€ 894,00
cod. 365. __/IEULB polished/lucida	€ 920,00
cod. 365. __/IBUBB white/bianca	€ 946,00
cod. 365. __/IBUNB black/nera	€ 946,00
cod. 365. __/IBULB polished/lucida	€ 972,00
cod. 365. __/IDKUBB white/bianca	€ 1.072,00
cod. 365. __/IDKUNB black/nera	€ 1.072,00
cod. 365. __/IDKULB polished/lucida	€ 1.098,00
cod. 365. __/ITCUBB white/bianca	€ 840,00
cod. 365. __/ITCUNB black/nera	€ 840,00
cod. 365. __/ITCULB polished/lucida	€ 866,00

Felt Glides / Tappi in feltro
Fabric required
Fabbisogno di tessuto
1 pcs: Lin Mtrs 1,2 (h1,40)

COM fabric min. order
10pcs each code
Tessuto cliente TC ordine
min. 10pz per codice

Min. order 4pcs
each code
Ordine min 4pz
per codice

Armrests available colors
Colori per braccioli disponibili
00-06-10-14-51-54

KANVAS 2 UR FULL



Techno-polymer shell, swivel on 4-blade aluminum painted base, with castors, full upholstered shell.
Scocca in tecnopolimero, girevole su basamento verniciato in alluminio a 4 razze, su ruote, scocca rivestita full.

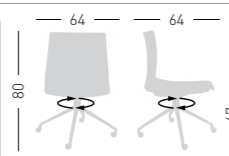

NA not assembled / non assemblato



Frame Finishing & Codes / Finiture Telai e Codici

cod.365. __/IKURB white/bianca	€ 826,00
cod.365. __/IKURN black/nera	€ 826,00
cod.365. __/IKURL polished/lucida	€ 852,00
cod.365. __/IEURB white/bianca	€ 826,00
cod.365. __/IEURN black/nera	€ 826,00
cod.365. __/IEURL polished/lucida	€ 852,00
cod.365. __/IBURB white/bianca	€ 878,00
cod.365. __/IBURN black/nera	€ 878,00
cod.365. __/IBURL polished/lucida	€ 904,00
cod.365. __/IDKURB white/bianca	€ 1.008,00
cod.365. __/IDKURN black/nera	€ 1.008,00
cod.365. __/IDKURL polished/lucida	€ 1.034,00
cod.365. __/ITCURB white/bianca	€ 772,00
cod.365. __/ITCURN black/nera	€ 772,00
cod.365. __/ITCURL polished/lucida	€ 798,00

Fabric required
Fabbisogno di tessuto
1 pcs: Lin Mtrs 1,2 (h1,40)

COM fabric min. order
10pcs each code
Tessuto cliente TC ordine
min. 10pz per codice

Min. order 4pcs
each code
Ordine min 4pz
per codice

KANVAS 2 UR BR FULL



Techno-polymer shell, swivel on 4-blade aluminum painted base, with castors and armrests, full upholstered shell.
Scocca in tecnopolimero, girevole su basamento verniciato in alluminio a 4 razze su ruote, braccioli, scocca rivestita full.

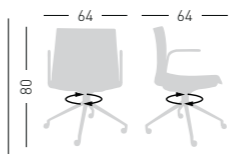

NA not assembled / non assemblato



Frame Finishing & Codes / Finiture Telai e Codici

cod. 365. __/IKURB white/bianca	€ 904,00
cod. 365. __/IKURN black/nera	€ 904,00
cod. 365. __/IKURL polished/lucida	€ 932,00
cod. 365. __/IEURB white/bianca	€ 904,00
cod. 365. __/IEURN black/nera	€ 904,00
cod. 365. __/IEURL polished/lucida	€ 932,00
cod. 365. __/IBURB white/bianca	€ 960,00
cod. 365. __/IBURN black/nera	€ 960,00
cod. 365. __/IBURL polished/lucida	€ 986,00
cod. 365. __/IDKURB white/bianca	€ 1.086,00
cod. 365. __/IDKURN black/nera	€ 1.086,00
cod. 365. __/IDKURL polished/lucida	€ 1.114,00
cod. 365./ITCURB white/bianca	€ 852,00
cod. 365./ITCURN black/nera	€ 852,00
cod. 365./ITCURL polished/lucida	€ 878,00

Fabric required
Fabbisogno di tessuto
1 pcs: Lin Mtrs 1,2 (h1,40)

COM fabric min. order
10pcs each code
Tessuto cliente TC ordine
min. 10pz per codice

Min. order 4pcs
each code
Ordine min 4pz
per codice

Armrests available colors
Colori per braccioli disponibili
00-06-10-14-51-54

KANVAS 2 05R COACH FULL



Swivel on 5-blade painted or polished aluminum base with castors, height adjustable, technopolymer shell, rotating tablet, full upholstered shell.
Girevole su basamento 5 razze in alluminio verniciato o pulito con ruote, regolabile in altezza, scocca in tecnopolimero, tavoletta rotante, scocca rivestita full.

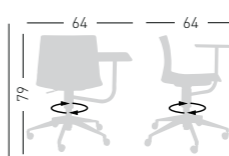

A assembled / assemblato



Frame Finishing & Codes / Finiture Telai e Codici

cod. 365. __/IEC05R polished/pulita	€ 1.514,00
cod. 365. __/IEC05RN black painted/verniciata nera	€ 1.498,00
cod. 365. __/IKC05R polished/pulita	€ 1.514,00
cod. 365. __/IKC05RN black painted/verniciata nera	€ 1.498,00
cod. 365. __/IBC05R polished/pulita	€ 1.552,00
cod. 365. __/IBC05RN black painted/verniciata nera	€ 1.540,00
cod. 365. __/IDKC05R polished/pulita	€ 1.694,00
cod. 365. __/IDKC05RN black painted/verniciata nera	€ 1.678,00
cod. 365./ITCC05R polished/pulita	€ 1.458,00
cod. 365./ITCC05RN black painted/verniciata nera	€ 1.446,00

COM fabric min. order
10pcs each code
Tessuto cliente TC ordine
min. 10pz per codice

Min. order 4pcs
each code
Ordine min 4pz
per codice

Kanvas Lounge



Available coverings / Finiture disponibili
 Aurea eco-leather / Ecopelle aurea **E** (2pcs min.)
 King fabric / Tessuto King **K** (2pcs min.)
 Blazer fabric / Tessuto Blazer **B** (2pcs min.)
 Kvadrat fabrics / Tessuti Kvadrat **DK** (2pcs min.)
 COM fabric / Tessuto cliente **TC** (10pcs min.)

Products follows UNI 9175 -UNI 9175/FA, in terms of Fire Resistance, Fire Reation Class T1M
 Prodotto Omologato dal Ministero dell'Interno , secondo la UNI 9175 -UNI 9175/FA, con classe di Reazione al fuoco T1M



KANVAS LOUNGE L

Swivel on 4-blade chromed or white painted steel base, upholstered shell.
 Girevole su basamento 4 razze in acciaio cromato o verniciato bianco, scocca rivestita.

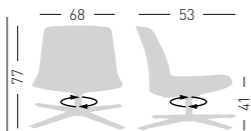

A assembled / assemblato



Frame Finishing & Codes / Finiture Telai e Codici

cod. 368.--/IKL chromed/cromata	€ 1.384,00
cod. 368.--/IKLB white painted/verniciato bianco	€ 1.304,00
cod. 368.--/IBL chromed/cromata	€ 1.518,00
cod. 368.--/IBLB white painted/verniciato bianco	€ 1.518,00
cod. 368.--/IEL chromed/cromata	€ 1.384,00
cod. 368.--/IELB white painted/verniciato bianco	€ 1.384,00
cod. 368.--/IDKL chromed/cromata	€ 1.758,00
cod. 368.--/IDKLB white painted/verniciato bianco	€ 1.758,00
cod. 368.--/ITCL chromed/cromata	€ 1.304,00
cod. 368.--/ITCLB white painted/verniciato bianco	€ 1.304,00

Fabric required
 Fabbisogno di tessuto
 1 pcs: Lin Mtrs 1,5 (h1,40)

COM fabric min. order
 10pcs each code
 Tessuto cliente TC ordine
 min. 10pz per codice

Min. order 2pcs
 each code
 Ordine min 2pz
 per codice

KANVAS LOUNGE LS

Swivel on 4-blade black painted die cast aluminum base, tilt mechanism, upholstered shell.
 Girevole su basamento a 4 razze in alluminio verniciato nero, meccanismo tilt, scocca rivestita.

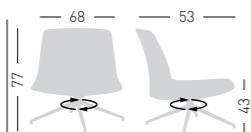

A assembled / assemblato



Frame Finishing & Codes / Finiture Telai e Codici

cod. 368.--/IKLSN	€ 1.320,00
cod. 368.--/IBLSN	€ 1.452,00
cod. 368.--/IELSN	€ 1.320,00
cod. 368.--/IDKLSN	€ 1.692,00
cod. 368.--/ITCLSN	€ 1.238,00

Fabric required
 Fabbisogno di tessuto
 1 pcs: Lin Mtrs 1,5 (h1,40)

COM fabric min. order
 10pcs each code
 Tessuto cliente TC ordine
 min. 10pz per codice

Min. order 2pcs
 each code
 Ordine min 2pz
 per codice

KANVAS LOUNGE ST

Chromed or Painted metal sled frame, upholstered shell.
 Struttura a slitta in metallo, cromata o verniciata, scocca rivestita.

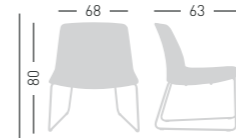

A assembled / assemblato



Frame Finishing & Codes / Finiture Telai e Codici

cod. 368.--/IEST chromed/cromata	€ 1.214,00
cod. 368.--/IESTB white painted/verniciato bianco	€ 1.252,00
cod. 368.--/IESTN black painted/verniciato nero	€ 1.252,00
cod. 368.--/IKST chromed/cromata	€ 1.214,00
cod. 368.--/IKSTB white painted/verniciato bianco	€ 1.252,00
cod. 368.--/IKSTN black painted/verniciato nero	€ 1.252,00
cod. 368.--/IBST chromed/cromata	€ 1.348,00
cod. 368.--/IBSTB white painted/verniciato bianco	€ 1.384,00
cod. 368.--/IBSTN black painted/verniciato nero	€ 1.384,00
cod. 368.--/IDKST chromed/cromata	€ 1.588,00
cod. 368.--/IDKSTB white painted/verniciato bianco	€ 1.624,00
cod. 368.--/IDKSTN black painted/verniciato nero	€ 1.624,00
cod. 368.--/ITCST chromed/cromata	€ 1.136,00
cod. 368.--/ITCSTB white painted/verniciato bianco	€ 1.170,00
cod. 368.--/ITCSTN black painted/verniciato nero	€ 1.170,00

Fabric required
 Fabbisogno di tessuto
 1 pcs: Lin Mtrs 1,5 (h1,40)

COM fabric min. order
 10pcs each code
 Tessuto cliente TC ordine
 min. 10pz per codice

Min. order 2pcs
 each code
 Ordine min 2pz
 per codice



Kasia

Available shell color / Colori disponibili scocca



Frame finishes / Finiture telaio

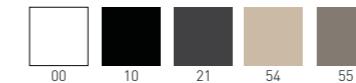

KASIA

4-Legged metal frame, painted with special treatment for outdoor purpose, techno-polymer shell.
 Telaio 4 gambe in metallo verniciato con trattamento per esterno, scocca in tecnopolimero.

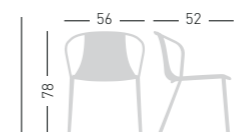

stackable / impilabile (4pcs)

A assembled / assemblato



Frame Finishing & Codes / Finiture Telai e Codici

cod. 186._/A_	€ 282,00
---------------	----------

Min. order 4pcs
 each code
 Ordine min 4pz
 per codice

KASIA B



4-Legged metal frame with armrest, painted with treatment for outdoor purpose, techno-polymer shell.
Telaio 4 gambe con braccioli in metallo verniciato con trattamento per esterno, scocca in tecnopolimero.

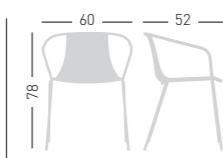

stackable / impilabile (4pcs)
A assembled / assemblato



0,35 m³ - 21 kg.
57x63x97cm.
4 pcs (carton)

Frame Finishing & Codes / Finiture Telai e Codici

cod. 187._/A_

€ 312,00

Min. order 4pcs
each code
Ordine min 4pz
per codice

KASIA UPHOLSTERED IMBOTTITE



Suitable for outdoor purpose with MG finishes.
Adatto all'uso per esterni con finiture MG.

Available coverings / Finiture disponibili
King fabric / Tessuto King **K** (4pcs min.)
Maglia fabric / Tessuto Maglia **MG** (4pcs min.)
Superb Trevira Velvet / Velluto Superb Trevira **S** (4pcs min.)

KASIA UPHOLSTERED



4-Legged metal frame, painted with special treatment for outdoor purpose, padded and upholstered shell.
Telaio 4 gambe in metallo verniciato con trattamento per esterno, scocca imbottita e rivestita.

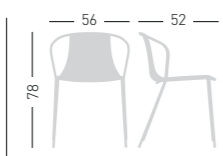

A assembled / assemblato



0,35 m³ - 11,5 kg.
57x63x97cm.
2 pcs (carton)

Frame Finishing & Codes / Finiture Telai e Codici

cod. 186._/IKA_
cod. 186._/IMGA_
cod. 186._/ISA_

€ 584,00
€ 584,00
€ 584,00

Min. order 4pcs
each code
Ordine min 4pz
per codice

KASIA B UPHOLSTERED



4-Legged metal frame with armrest, painted with treatment for outdoor purpose, padded and upholstered shell.
Telaio 4 gambe con braccioli in metallo verniciato con trattamento per esterno, scocca imbottita e rivestita.

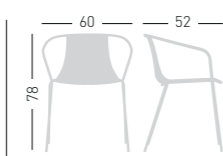

A assembled / assemblato



0,35 m³ - 12,3 kg.
57x63x97cm.
2 pcs (carton)

Frame Finishing & Codes / Finiture Telai e Codici

cod. 187._/IKA_
cod. 187._/IMGA_
cod. 187._/ISA_

€ 614,00
€ 614,00
€ 614,00

Min. order 4pcs
each code
Ordine min 4pz
per codice



Available colors / Colori disponibili



LIBERTY



Seat and back in techno-polymer, anodized aluminum legs.
Seduta e schienale in tecnopolimero e gambe in alluminio anodizzato.

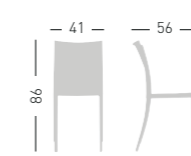

stackable / impilabile (6pcs)
A assembled / assemblato



0,29 m³ - 20 kg.
62,5x46x97cm.
4 pcs (carton)

Frame Finishing & Codes / Finiture Telai e Codici

cod.22.--/A

€ 168,00



Available colors / Colori disponibili



LILÀ

Chair with painted plywood shell, chromed metal frame.
Sedia con scocca in multistrato curvato verniciato, telaio cromato.

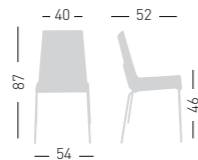

A assembled / assemblato



0,38 m³ - 18 kg.
59x65x99cm.
3 pcs [carton]

Frame Finishing & Codes / Finiture Tetai e Codici

cod.184.--/A

€ 280,00

**LILÀ
UPHOLSTERED
IMBOTTITE**

Available coverings / Finiture disponibili
Regenerated leather / Pelle rigenerata PR (4pcs min.)

**LILÀ
UPHOLSTERED**

Chair in regenerated leather and chromed metal frame.
Sedia rivestita in pelle rigenerata e telaio in metallo cromato.

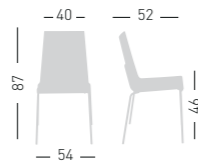

A assembled / assemblato



0,35 m³ - 13 kg.
60x60x96cm.
2 pcs [carton]

Frame Finishing & Codes / Finiture Tetai e Codici

cod.184.--/IPRA chromed/cromata

€ 470,00

Min. order 4pcs
each code
Ordine min 4pz
per codice



Available colors / Colori disponibili



Zero Waste Selection - 100% Recycled



LILIBET

4-legged stackable techno-polymer side chair.
Sedia impilabile in tecnopolimero.

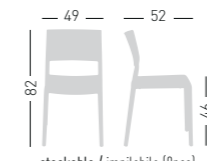

stackable / impilabile (8pcs)

A assembled / assemblato



0,35 m³ - 17,6 kg.
57x63x97cm.
4 pcs [carton]

Frame Finishing & Codes / Finiture Tetai e Codici

cod. 373.__/A

€ 132,00

LILIBET B



4-legged stackable techno-polymer armchair.
Sedia impilabile in tecnopolimero con braccioli.

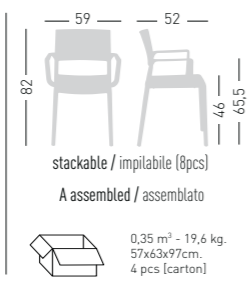

Frame Finishing & Codes / Finiture Telai e Codici

cod.374.--/A

€ 150,00

LILIBET CUSHION / CUSCINO



Upholstered cushion.
Cuscino tappezzato.

Available fabric.
Tessuti disponibili.
K, MG



Suitable for outdoor purpose with MG finishes.
Adatto all'uso per esterni con finiture MG.



0,5 kg.
Inside chairs boxes
Nella scatola delle sedie.

Frame Finishing & Codes / Finiture Telai e Codici

cod.307.-- (K)
cod.307.-- (MG)

€ 118,00
€ 128,00



Available colors / Colori disponibili

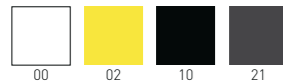

LINK



4-Legged metal chair, painted for outdoor.
Struttura 4 gambe in metallo verniciato per esterno.

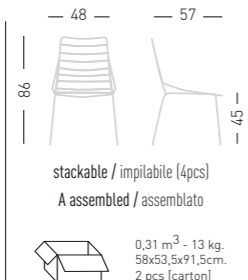

Frame Finishing & Codes / Finiture Telai e Codici

cod.86.--/A

€ 374,00

Min. order 4pcs
each code
Ordine min 4pz
per codice

LINK B



4-Legged metal chair with armrests, painted for outdoor.
Struttura 4 gambe con braccioli in metallo verniciato per esterno.

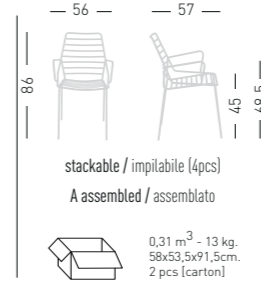

Frame Finishing & Codes / Finiture Telai e Codici

cod.88.--/A

€ 454,00

Min. order 4pcs
each code
Ordine min 4pz
per codice

LINK CUSHION / CUSCINO



Cushion for Link chairs and armchairs, with removable cover, suitable for outdoor purpose; high density bi-elastic rubber padding, stitching made with raised edge. The cushion is fixed to the chair by Velcro straps.

Cuscino sfoderabile per sedie e sedie con braccioli Link, adatto ad uso per esterni; imbottiture in gomma bielastica ad alta densità, cucitura realizzata con bordino in rilievo riportato. Il cuscino si fissa alla sedia per mezzo di fascette in Velcro.



0,51 kg.
Inside chairs boxes
Nella scatola delle sedie.

Frame Finishing & Codes / Finiture Telai e Codici

cod. 336.-- (MG)
cod. 336.-- (SX)

€ 150,00
€ 150,00

Min. order 4pcs
each code
Ordine min 4pz
per codice

Available fabric / Tessuti disponibili
Maglia fabric / Tessuto Maglia **MG**
Silvertex Fabric / Tessuto Silvertex **SX**

LINK SEAT & BACK CUSHION / CUSCINO SEDIE SCHIENALE



Cushion for Link chairs and armchairs, suitable for outdoor purpose. The cushion is fixed to the chair by clip buttons.

Cuscino per sedie e poltroncine Link, adatto ad uso per esterni. Il cuscino si fissa alla sedia per mezzo di bottoni a clip.



1 kg.
Inside chairs boxes
Nella scatola delle sedie.

Frame Finishing & Codes / Finiture Telai e Codici

cod.316.-- (MG)
cod.316.-- (SX)

€ 304,00
€ 304,00

Min. order 4pcs
each code
Ordine min 4pz
per codice

Available fabric / Tessuti disponibili
Maglia fabric / Tessuto Maglia **MG**
Silvertex Fabric / Tessuto Silvertex **SX**

LINK LOUNGE



4-Legged lounge metal chair with armrests, painted for outdoor.
Seduta 4 gambe lounge con braccioli in metallo, verniciato per esterno.

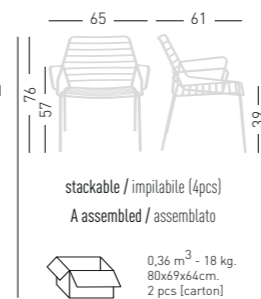

Frame Finishing & Codes / Finiture Telai e Codici

cod.84.--/A

€ 576,00

LINK LOUNGE CUSHION / CUSCINO



Cushion for Link lounge chair, with removable cover, suitable for outdoor purpose; high density bi-elastic rubber padding, stitching made with raised edge. The cushion is fixed to the chair by Velcro straps.

Cuscino sfoderabile per sedie lounge Link, adatto ad uso per esterni; imbottiture in gomma bielastica ad alta densità, cucitura realizzata con bordino in rilievo riportato. Il cuscino si fissa alla sedia per mezzo di fascette in Velcro.



0,67 kg.
Inside chairs boxes
Nella scatola delle sedie.

Frame Finishing & Codes / Finiture Telai e Codici

cod.340.-- (MG)
cod.340.-- (SX)

€ 172,00
€ 172,00

Min. order 4pcs
each code
Ordine min 4pz
per codice

Available fabric / Tessuti disponibili
Maglia fabric / Tessuto Maglia **MG**
Silvertex Fabric / Tessuto Silvertex **SX**

LINK CHAISE LONGUE

Metal chaise longue, painted for outdoor.
Chaise longue in metallo, verniciato per esterno.

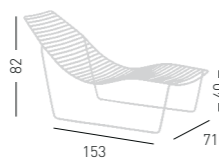

A assembled / assemblato



1,1 m³ - 17 kg.
90x165x73cm.
1 pcs (carton)

Frame Finishing & Codes / Finiture Telaie e Codici

cod.85.--/A

€ 2.004,00



Manaa

Products follows UNI 9175 -UNI 9175/FA, in terms of Fire Resistance, Fire Reation Class 1IM
Prodotto Omologato dal Ministero dell'Interno, secondo la UNI 9175 -UNI 9175/FA, con classe di Reazione al fuoco 1IM



Available coverings / Finiture disponibili
King fabric / Tessuto King **K** (4pcs min.)
Blazer fabric / Tessuto Blazer **B** (4pcs min.)
Superb Trevira Velvet / Velluto Superb Trevira **S** (4pcs min.)
Leather / Pelle **P** (4pcs min.)
Aurea eco-leather / Ecopelle Aurea **E** (4pcs min.)
Kvadrat fabrics / Tessuti Kvadrat **DK** (4pcs min.)
COM fabric / Tessuto cliente **TC** (10pcs min.)

Frame / Telaio



MANAA TP

Upholstered armchair, techno-polymer base.
Poltrona rivestita, telaio in tecnopolimero.



A assembled / assemblato

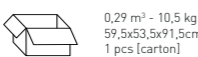

0,29 m³ - 10,5 kg.
59,5x53,5x91,5cm.
1 pcs (carton)

Frame Finishing & Codes / Finiture Telaie e Codici

cod.255.--/IKTP--
cod.255.--/IBTP--
cod.255.--/ISTP--
cod.255.--/IPTP--
cod.255.--/IETP--
cod.255.--/IDKTP--
cod.255.--/ITCTP--

€ 822,00
€ 936,00
€ 936,00
€ 1.040,00
€ 822,00
€ 1.040,00
€ 772,00

Twin color upholstery details available on request
Dettagli tappezzeria bi-colore disponibili su richiesta

Fabric required
Fabbisogno di tessuto
1 pcs: Lin Mtrs 1 [h1,40]

COM fabric min. order
10pcs each code
Tessuto cliente TC ordine
min. 10pz per codice

Min. order 4pcs
each code
Ordine min 4pz
per codice

MANAA BL

Upholstered armchair, 4-Legged wooden beech frame.
Poltrona rivestita, struttura in legno di faggio 4 gambe.



Price + € 20,00

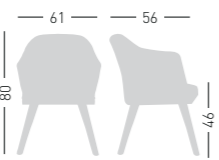

A assembled / assemblato



0,29 m³ - 11 kg.
59,5x53,5x91,5cm.
1 pcs (carton)

Frame Finishing & Codes / Finiture Telaie e Codici

cod.255.--/IBBL_
cod.255.--/ISBL_
cod.255.--/IKBL_
cod.255.--/IEBL_
cod.255.--/IDKBL_
cod.255.--/IPBL_
cod.255./ITCBL_

€ 1.164,00
€ 1.164,00
€ 1.054,00
€ 1.054,00
€ 1.272,00
€ 1.272,00
€ 1.002,00

Felt Glides / Tappi in feltro

Twin color upholstery details available on request
Dettagli tappezzeria bi-colore disponibili su richiesta

Fabric required
Fabbisogno di tessuto
1 pcs: Lin Mtrs 1 [h1,40]

COM fabric min. order
10pcs each code
Tessuto cliente TC ordine
min. 10pz per codice

Min. order 4pcs
each code
Ordine min 4pz
per codice

MANAA 05R

Upholstered armchair, swivel on 5-spur polished or black painted aluminum base, tilt mechanism, height adjustable.
Poltrona rivestita, girevole su basamento 5 razze in alluminio pulito o verniciato nero, meccanismo oscillante, regolabile in altezza.

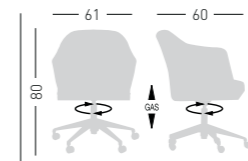

NA not assembled / non assemblato



0,26 m³ - 12 kg.
64x64x64cm.
1 pcs (carton)

Frame Finishing & Codes / Finiture Telaie e Codici

cod.255._/IB05RN black/nero
cod.255._/IB05R polished/lucido
cod.255._/IS05RN black/nero
cod.255._/IS05R polished/lucido
cod.255._/IK05RN black/nero
cod.255._/IK05R polished/lucido
cod.255._/IE05RN black/nero
cod.255._/IE05R polished/lucido
cod.255._/IDK05RN black/nero
cod.255._/IDK05R polished/lucido
cod.255._/IP05RN black/nero
cod.255._/IP05R polished/lucido
cod.255._/ITC05RN black/nero
cod.255._/ITC05R polished/lucido

€ 1.134,00
€ 1.144,00
€ 1.134,00
€ 1.144,00
€ 1.020,00
€ 1.034,00
€ 1.020,00
€ 1.034,00
€ 1.238,00
€ 1.252,00
€ 1.238,00
€ 1.252,00
€ 970,00
€ 984,00

Twin color upholstery details available on request
Dettagli tappezzeria bi-colore disponibili su richiesta

Fabric required
Fabbisogno di tessuto
1 pcs: Lin Mtrs 1 [h1,40]

COM fabric min. order
10pcs each code
Tessuto cliente TC ordine
min. 10pz per codice

Min. order 4pcs
each code
Ordine min 4pz
per codice

MANAA U

Upholstered armchair, swivel on 4-blade aluminum painted or polished base, tilt mechanism.
Poltrona rivestita, girevole su basamento verniciato o pulito in alluminio a 4 razze, meccanismo oscillante.

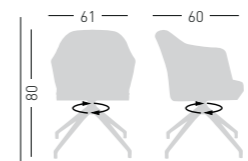

A assembled / assemblato



0,29 m³ - 12 kg.
59,5x53,5x91,5cm.
1 pcs (carton)

Frame Finishing & Codes / Finiture Telaie e Codici

cod.255._/IBUB white/bianco
cod.255._/IBUN black/nero
cod.255._/IBUL polished/lucido
cod.255._/ISUB white/bianco
cod.255._/ISUN black/nero
cod.255._/ISUL polished/lucido
cod.255._/IKUB white/bianco
cod.255._/IKUN black/nero
cod.255._/IKUL polished/lucido
cod.255._/IEUB white/bianco
cod.255._/IEUN black/nero
cod.255._/IEUL polished/lucido
cod.255._/IDKUB white/bianco
cod.255._/IDKUN black/nero
cod.255._/IDKUL polished/lucido
cod.255._/IPUB white/bianco
cod.255._/IPUN black/nero
cod.255._/IPUL polished/lucido
cod.255._/ITCUB white/bianco
cod.255._/ITCUN black/nero
cod.255._/ITCUL polished/lucido

€ 1.178,00
€ 1.178,00
€ 1.202,00
€ 1.178,00
€ 1.178,00
€ 1.202,00
€ 1.064,00
€ 1.064,00
€ 1.090,00
€ 1.064,00
€ 1.064,00
€ 1.090,00
€ 1.282,00
€ 1.282,00
€ 1.306,00
€ 1.282,00
€ 1.282,00
€ 1.306,00
€ 1.014,00
€ 1.014,00
€ 1.038,00

Felt Glides / Tappi in feltro

Twin color upholstery details available on request
Dettagli tappezzeria bi-colore disponibili su richiesta

Fabric required
Fabbisogno di tessuto
1 pcs: Lin Mtrs 1 [h1,40]

COM fabric min. order
10pcs each code
Tessuto cliente TC ordine
min. 10pz per codice

Min. order 4pcs
each code
Ordine min 4pz
per codice

Manaa Slim

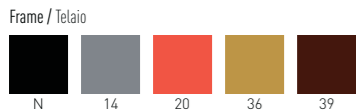

Products follows UNI 9175 -UNI 9175/FA, in terms of Fire Resistance, Fire Reation Class I1M
Prodotto Omologato dal Ministero dell'Interno, secondo la UNI 9175 -UNI 9175/FA, con classe di Reazione al fuoco I1M



Available coverings / Finiture disponibili
King fabric / Tessuto King **K** (4pcs min.)
Blazer fabric / Tessuto Blazer **B** (4pcs min.)
Superb Trevira Velvet / Velluto Superb Trevira **S** (4pcs min.)
Leather / Pelle **P** (4pcs min.)
Aurea eco-leather / Ecopelle Aurea **E** (4pcs min.)
Kvadrat fabrics / Tessuti Kvadrat **DK** (4pcs min.)
COM fabric / Tessuto cliente **TC** (10pcs min.)

MANAA SLIM TP



Upholstered chair, techno-polymer base. Poltroncina rivestita, telaio in tecnopolimero.

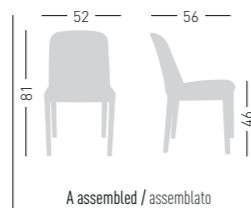

A assembled / assemblato

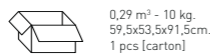

0,29 m³ - 10 kg.
59,5x53,5x91,5cm.
1 pcs (carton)

Frame Finishing & Codes / Finiture Telaie e Codici

cod.253.--/IKTP--	€ 750,00
cod.253.--/IETP--	€ 750,00
cod.253.--/IBTP--	€ 862,00
cod.253.--/ISTP--	€ 862,00
cod.253.--/IPTP--	€ 968,00
cod.253.--/IDKTP--	€ 968,00
cod.253./ITCTP--	€ 700,00

Twin color upholstery details available on request
Dettagli tappezzeria bi-colore disponibili su richiesta

Fabric required
Fabbisogno di tessuto
1 pcs: Lin Mtrs 1 (h1,40)

COM fabric min. order
10pcs each code
Tessuto cliente TC ordine
min. 10pz per codice

Min. order 4pcs
each code
Ordine min 4pz
per codice

MANAA SLIM BL



Upholstered chair, 4-Legged wooden beech frame. Poltroncina rivestita, struttura in legno di faggio 4 gambe.

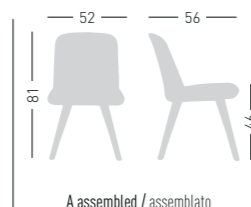

A assembled / assemblato

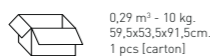

0,29 m³ - 10 kg.
59,5x53,5x91,5cm.
1 pcs (carton)

Frame Finishing & Codes / Finiture Telaie e Codici

cod.253.--/IKBL_	€ 980,00
cod.253.--/IEBL_	€ 980,00
cod.253.--/IBBL_	€ 1.092,00
cod.253.--/ISBL_	€ 1.092,00
cod.253.--/IPBL_	€ 1.196,00
cod.253.--/IDKBL_	€ 1.196,00
cod.253./ITCBL_	€ 928,00

Felt Glides / Tappi in feltro

Twin color upholstery details available on request
Dettagli tappezzeria bi-colore disponibili su richiesta

Fabric required
Fabbisogno di tessuto
1 pcs: Lin Mtrs 1 (h1,40)

COM fabric min. order
10pcs each code
Tessuto cliente TC ordine
min. 10pz per codice

Min. order 4pcs
each code
Ordine min 4pz
per codice

MANAA SLIM O5R



Upholstered chair, swivel on 5-spur polished or black painted aluminum base, tilt mechanism, height adjustable. Poltroncina rivestita, girevole su basamento 5 razze in alluminio lucido o verniciato nero, meccanismo oscillante, regolabile in altezza.

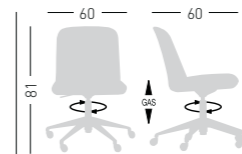

NA not assembled / non assemblato



0,26 m³ - 11,5 kg.
64x64x64cm.
1 pcs (carton)



0,29 m³
59,5x53,5x91,5cm.
1 pcs (carton)

Frame Finishing & Codes / Finiture Telaie e Codici

cod.253.--/IKO5RN black/nero	€ 948,00
cod.253.--/IKO5R polished/lucido	€ 962,00
cod.253.--/IEO5RN black/nero	€ 948,00
cod.253.--/IEO5R polished/lucido	€ 962,00
cod.253.--/IBO5RN black/nero	€ 1.060,00
cod.253.--/IBO5R polished/lucido	€ 1.072,00
cod.253.--/ISO5RN black/nero	€ 1.060,00
cod.253.--/ISO5R polished/lucido	€ 1.072,00
cod.253.--/IPO5RN black/nero	€ 1.166,00
cod.253.--/IPO5R polished/lucido	€ 1.180,00
cod.253.--/IDKO5RN black/nero	€ 1.166,00
cod.253.--/IDKO5R polished/lucido	€ 1.180,00
cod.253./ITCO5RN black/nero	€ 898,00
cod.253./ITCO5R polished/lucido	€ 910,00

Twin color upholstery details available on request
Dettagli tappezzeria bi-colore disponibili su richiesta

Fabric required
Fabbisogno di tessuto
1 pcs: Lin Mtrs 1 (h1,40)

COM fabric min. order
10pcs each code
Tessuto cliente TC ordine
min. 10pz per codice

Min. order 4pcs
each code
Ordine min 4pz
per codice

MANAA SLIM U



Upholstered chair, swivel on 4-blade aluminum painted or polished base, tilt mechanism. Poltroncina rivestita, girevole su basamento verniciato o lucido in alluminio a 4 razze, meccanismo oscillante.

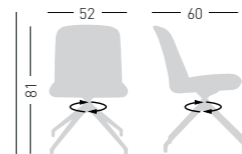

A assembled / assemblato



0,29 m³ - 11 kg.
59,5x53,5x91,5cm.
1 pcs (carton)

Frame Finishing & Codes / Finiture Telaie e Codici

cod. 253.--/IKUB white/bianco	€ 992,00
cod. 253.--/IKUN black/nero	€ 992,00
cod. 253.--/IKUL polished/lucido	€ 1.016,00
cod. 253.--/IEUB white/bianco	€ 992,00
cod. 253.--/IEUN black/nero	€ 992,00
cod. 253.--/IEUL polished/lucido	€ 1.016,00
cod. 253.--/IBUB white/bianco	€ 1.104,00
cod. 253.--/IBUN black/nero	€ 1.104,00
cod. 253.--/IBUL polished/lucido	€ 1.128,00
cod. 253.--/ISUB white/bianco	€ 1.104,00
cod. 253.--/ISUN black/nero	€ 1.104,00
cod. 253.--/ISUL polished/lucido	€ 1.128,00
cod. 253.--/IPUB white/bianco	€ 1.210,00
cod. 253.--/IPUN black/nero	€ 1.210,00
cod. 253.--/IPUL polished/lucido	€ 1.234,00
cod. 253.--/IDKUB white/bianco	€ 1.210,00
cod. 253.--/IDKUN black/nero	€ 1.210,00
cod. 253.--/IDKUL polished/lucido	€ 1.234,00
cod. 253./ITCUB white/bianco	€ 942,00
cod. 253./ITCUN black/nero	€ 942,00
cod. 253./ITCUL polished/lucido	€ 966,00

Felt Glides / Tappi in feltro

Twin color upholstery details available on request
Dettagli tappezzeria bi-colore disponibili su richiesta

Fabric required
Fabbisogno di tessuto
1 pcs: Lin Mtrs 1 (h1,40)

COM fabric min. order
10pcs each code
Tessuto cliente TC ordine
min. 10pz per codice

Min. order 4pcs
each code
Ordine min 4pz
per codice



Available colors / Colori disponibili

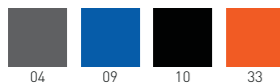

MAYA



Shell in techno polymer and anodized aluminum legs. Scocca in tecnopolimero e gambe in alluminio anodizzato.

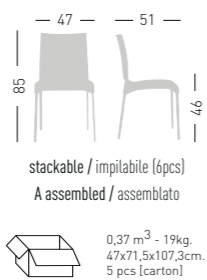

Frame Finishing & Codes / Finiture Tetai e Codici
cod.13.--/A
cod.13.--/IGN fire retardant / ignifuga
fire retardand minimum 300 pcs
ignifuga minimo 300 pz

€ **102,00**
€ **162,00**



Available colors / Colori disponibili

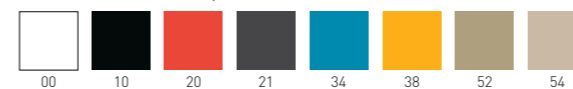

IGN Versions follows UNI 9177 certification in terms of Fire Resistance, Fire Reaction Class 1
Versioni IGN prodotto Omologato con Classe di Reazione al fuoco 1, UNI 9177



MINUSH



4-legged stackable techno-polymer chair. Seduta impilabile in tecnopolimero.

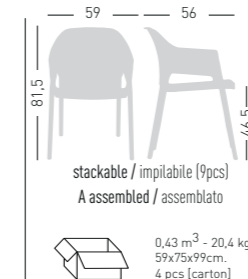

Frame Finishing & Codes / Finiture Tetai e Codici
cod.220.--/A
cod.220.--/IGN fire retardant / ignifuga
fire retardand minimum 300 pcs
ignifuga minimo 300 pz

€ **144,00**
€ **192,00**

MINUSH RELAX



4-legged stackable techno-polymer chair. Seduta impilabile in tecnopolimero.

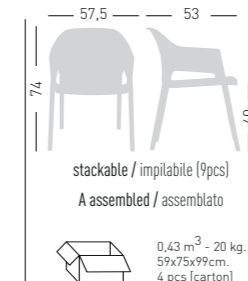

Frame Finishing & Codes / Finiture Tetai e Codici
cod.221.--/A

€ **194,00**

MINUSH CUSHION / CUSCINO



Removable cushion. Cuscino removibile.

Available fabric / Tessuti disponibili
Progarden fabric / Tessuto Progarden **GR**
Silvertex Fabric / Tessuto Silvertex **SX**
Maglia fabric / Tessuto Maglia **MG**



Frame Finishing & Codes / Finiture Tetai e Codici
cod.319.-- (GR)
cod.319.-- (SX)
cod.319.-- (MG)

€ **134,00**
€ **134,00**
€ **148,00**

Min. order 4pcs each code
Ordine min 4pz per codice



Available colors / Colori disponibili

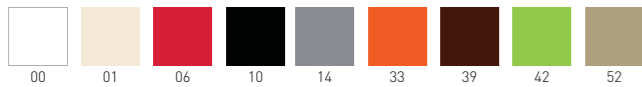

MOEMA 69



Chromed or painted 4-Legged metal frame; techno-polymer shell.
Struttura in metallo 4 gambe, cromata o verniciata; scocca in tecnopolimero.



only for painted frames
solo per telai verniciati

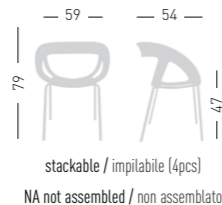

stackable / impilabile (4pcs)

NA not assembled / non assemblato



0,27 m³ - 22 kg.
64x64x64cm.
4 pcs [carton]

Frame Finishing & Codes / Finiture Telai e Codici

cod.69.--/NA chromed/cromata

cod.69.--/NAN black painted/verniciato nero

cod.69.--/NAB white painted/verniciato bianco

€ **172,00**

€ **206,00**

€ **206,00**

MOEMA BP



4 polymer-steel co-injected legs structure, techno-polymer shell.
Struttura 4 gambe in co-iniezione metallo-polimero, scocca in tecnopolimero.



NA not assembled / non assemblato



0,24 m³ - 24,2 kg.
66x55x63cm.
4 pcs [carton]

Frame Finishing & Codes / Finiture Telai e Codici

cod.69.--/BP-- technopolymer/tecnopolimero

Legs and shells colors can be combined
I colori delle gambe possono essere abbinati alla scocca

€ **300,00**

MOEMA BL



4-Legged wooden beech frame, techno-polymer shell.
Struttura in legno di faggio 4 gambe, scocca in tecnopolimero.



Price + € 20,00



NA not assembled / non assemblato



0,36 m³ - 25,0 kg.
60x56x51cm.



60x56x51cm.
4 pcs [carton]

Frame Finishing & Codes / Finiture Telai e Codici

cod.69.--/BL_

Felt Glides / Tappi in feltro

€ **336,00**

MOEMA 5R



Swivel on 5-spur polished aluminum base with castors, height adjustable, techno-polymer shell.

Girevole su basamento 5 razze con ruote in alluminio pulito, regolabile in altezza, scocca in tecnopolimero.



NA not assembled / non assemblato



0,24 m³ - 16,20 kg.
55x65,5x63cm.
2 pcs [carton]

Frame Finishing & Codes / Finiture Telai e Codici

cod.69.--/5R polished/lucida

€ **382,00**

MOEMA L



Swivel on 4-spur polished aluminum base, techno-polymer shell.

Girevole su basamento 4 razze in alluminio pulito, scocca in tecnopolimero.



NA not assembled / non assemblato



0,24 m³ - 14 kg.
55x65,5x63cm.
2 pcs [carton]

Frame Finishing & Codes / Finiture Telai e Codici

cod.69.--/L polished/lucida

€ **382,00**

Felt Glides / Tappi in feltro

MOEMA V



Swivel on chromed metal base, height adjustable, techno-polymer shell.

Girevole su basamento in metallo cromato, regolabile in altezza, scocca in tecnopolimero.



NA not assembled / non assemblato



0,18 m³ - 17,8 kg.
62x57x42cm.
2 pcs [carton]

Frame Finishing & Codes / Finiture Telai e Codici

cod.69.--/V chromed/cromata

€ **368,00**

MOEMA 05R



Swivel on 5-spur polished or painted aluminum base with castors, height adjustable, techno-polymer shell.

Girevole su basamento 5 razze in alluminio pulito o verniciato con ruote, regolabile in altezza, scocca in tecnopolimero.



NA not assembled / non assemblato



0,24 m³ - 16 kg.
55x65,5x63cm.
2 pcs [carton]

Frame Finishing & Codes / Finiture Telai e Codici

cod.69._/05R polished/lucido

cod.69._/05RN black/nero

€ **356,00**

€ **344,00**

MOEMA U



Swivel on 4-blade aluminum painted base, with glides.

Girevole su basamento verniciato in alluminio a 4 razze su piedini.

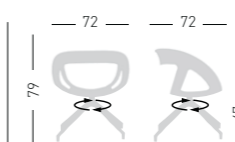

NA not assembled / non assemblato



0,33 m³ - 8,1 kg.
60x56x51cm.



62x57x42cm.
1 pcs [carton]

Frame Finishing & Codes / Finiture Telai e Codici

cod.69._/UB white/bianco

cod.69._/UN black/nero

€ **356,00**

€ **356,00**

Felt Glides / Tappi in feltro

MOEMA UR



Swivel on 4-blade aluminum painted base, with castors.
Girevole su basamento verniciato in alluminio a 4 razze su ruote.

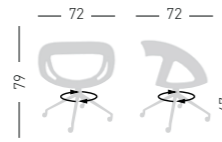

NA not assembled / non assemblato



Frame Finishing & Codes / Finiture Telai e Codici

cod.69._/URB white/bianco
cod.69._/URN black/nero

€ 368,00
€ 368,00

MOEMA CUSHION / CUSCINO



Upholstered cushion.
Cuscino tappezzato.



0,6 kg.
Inside chairs boxes
Inseriti nella
scatola delle sedie

Available fabric.
Tessuti disponibili.
B, E, K
COM fabric / Tessuto cliente **TC**

Frame Finishing & Codes / Finiture Telai e Codici

cod.310.--
cod.310.-- (B)
cod.310.TC COM fabric/tessuto cliente

€ 112,00
€ 128,00
€ 100,00

Fabric required
Fabbisogno di tessuto
4 pcs: Lin Mtrs 1,0 (h1,40)

COM fabric min. order
10pcs each code
Tessuto cliente TC ordine
min. 10pz per codice

Min. order 4pcs
each code
Ordine min 4pz
per codice

MOEMA UPHOLSTERED IMBOTTITE

Available coverings / Finiture disponibili
Leather / Pelle **P** (4pcs min.)
King fabric / Tessuto King **K** (4pcs min.)
Aurea eco-leather / Ecopelle aurea **E** (4pcs min.)
COM fabric / Tessuto cliente **TC** (10pcs min.)

MOEMA 75 UPHOLSTERED



4-Legged upholstered chair, chrome or painted, metal frame.
Sedia tappezzata 4 gambe, telaio in metallo cromato o verniciato.

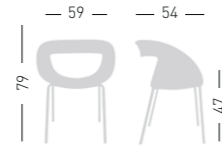

NA not assembled / non assemblato



Frame Finishing & Codes / Finiture Telai e Codici

cod.75.--/IPNA chromed/cromata
cod.75.--/IPNAN black painted/verniciato nero
cod.75.--/IPNAB white painted/verniciato bianco
cod.75.--/IKNA chromed/cromata
cod.75.--/IKNAN black painted/verniciato nero
cod.75.--/IKNAB white painted/verniciato bianco
cod.75.--/IENA chromed/cromata
cod.75.--/IENAN black painted/verniciato nero
cod.75.--/IENAB white painted/verniciato bianco
cod.75./ITCNA chromed/cromata
cod.75./ITCNAN black painted/verniciato nero
cod.75./ITCNAB white painted/verniciato bianco

€ 672,00
€ 698,00
€ 698,00
€ 618,00
€ 644,00
€ 644,00
€ 618,00
€ 644,00
€ 644,00
€ 586,00
€ 614,00
€ 614,00

Fabric required
Fabbisogno di tessuto
1 pcs: Lin Mtrs 1,5 (h1,40)

COM fabric min. order
10pcs each code
Tessuto cliente TC ordine
min. 10pz per codice

Min. order 4pcs
each code
Ordine min 4pz
per codice

MOEMA BP UPHOLSTERED



4-Legged upholstered chair, metal-polymer co-injected structure.
Sedia tappezzata 4 gambe, struttura in metallo-polimero co-iniettata.



NA not assembled / non assemblato



Frame Finishing & Codes / Finiture Telai e Codici

cod.75.--/IPBP-- technopolymer/tecnopolimero
cod.75.--/IKBP-- technopolymer/tecnopolimero
cod.75.--/IEBP-- technopolymer/tecnopolimero
cod.75./ITCBP-- technopolymer/tecnopolimero

€ 694,00
€ 638,00
€ 638,00
€ 608,00

Fabric required
Fabbisogno di tessuto
1 pcs: Lin Mtrs 1,5 (h1,40)

COM fabric min. order
10pcs each code
Tessuto cliente TC ordine
min. 10pz per codice

Min. order 4pcs
each code
Ordine min 4pz
per codice

MOEMA 75 BL UPHOLSTERED



4-Legged upholstered chair, wooden beech frame.
Sedia tappezzata 4 gambe, telaio in legno di faggio.



NA not assembled / non assemblato



Frame Finishing & Codes / Finiture Telai e Codici

cod.75.--/IPBL_
cod.75.--/IKBL_
cod.75.--/IEBL_
cod.75./ITCBL_

€ 726,00
€ 674,00
€ 674,00
€ 642,00

Felt Glides / Tappi in feltro

Fabric required
Fabbisogno di tessuto
1 pcs: Lin Mtrs 1,5 (h1,40)

COM fabric min. order
10pcs each code
Tessuto cliente TC ordine
min. 10pz per codice

Min. order 4pcs
each code
Ordine min 4pz
per codice

MOEMA 75 5R UPHOLSTERED



Swivel upholstered chair, height adjustment, aluminum polished base.
Sedia tappezzata girevole, regolabile in altezza, base in alluminio pulito.

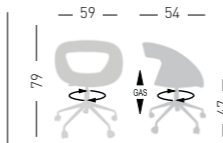

NA not assembled / non assemblato



Frame Finishing & Codes / Finiture Telai e Codici

cod.75.--/IP5R polished/lucida
cod.75.--/IK5R polished/lucida
cod.75.--/IE5R polished/lucida
cod.75./ITC5R polished/lucida

€ 896,00
€ 842,00
€ 842,00
€ 808,00

Fabric required
Fabbisogno di tessuto
1 pcs: Lin Mtrs 1,5 (h1,40)

COM fabric min. order
10pcs each code
Tessuto cliente TC ordine
min. 10pz per codice

Min. order 4pcs
each code
Ordine min 4pz
per codice

MOEMA 75 L UPHOLSTERED



Swivel upholstered chair, aluminum polished base.
Sedia tappezzata girevole, base in alluminio pulito.

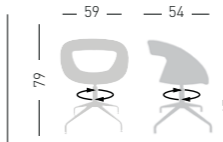

NA not assembled / non assemblato



Frame Finishing & Codes / Finiture Telai e Codici

cod.75.--/IPL polished/lucida
cod.75.--/IKL polished/lucida
cod.75.--/IEL polished/lucida
cod.75./ITCL polished/lucida

€ 896,00
€ 842,00
€ 842,00
€ 808,00

Felt Glides / Tappi in feltro

Fabric required
Fabbisogno di tessuto
1 pcs: Lin Mtrs 1,5 (h1,40)

COM fabric min. order
10pcs each code
Tessuto cliente TC ordine
min. 10pz per codice

Min. order 4pcs
each code
Ordine min 4pz
per codice

MOEMA 75 V UPHOLSTERED



Swivel upholstered chair, chromed base.
Sedia tappezzata girevole, base in metallo cromato.

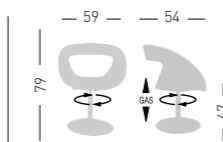

NA not assembled / non assemblato



Frame Finishing & Codes / Finiture Telai e Codici

cod.75.--/IPV chromed/cromata
cod.75.--/IKV chromed/cromata
cod.75.--/IEV chromed/cromata
cod.75./ITCV chromed/cromata

€ 878,00
€ 826,00
€ 826,00
€ 796,00

Fabric required
Fabbisogno di tessuto
1 pcs: Lin Mtrs 1,5 (h1,40)

COM fabric min. order
10pcs each code
Tessuto cliente TC ordine
min. 10pz per codice

Min. order 4pcs
each code
Ordine min 4pz
per codice

MOEMA 05R UPHOLSTERED



Swivel upholstered chair, height adjustment, aluminum polished or painted base.
Sedia tappezzata girevole, regolabile in altezza, base in alluminio pulita o verniciata.

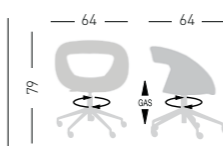

NA not assembled / non assemblato



Frame Finishing & Codes / Finiture Telai e Codici

cod.75._/IPO5R polished/lucida
cod.75._/IPO5RN black/nero
cod.75._/IKO5R polished/lucida
cod.75._/IKO5RN black/nero
cod.75._/IEO5R polished/lucida
cod.75._/IEO5RN black/nero
cod.75./ITCO5R polished/lucida
cod.75./ITCO5RN black/nero

€ 872,00
€ 856,00
€ 818,00
€ 804,00
€ 818,00
€ 804,00
€ 790,00
€ 772,00

Fabric required
Fabbisogno di tessuto
1 pcs: Lin Mtrs 1,5 (h1,40)

COM fabric min. order
10pcs each code
Tessuto cliente TC ordine
min. 10pz per codice

Min. order 4pcs
each code
Ordine min 4pz
per codice

MOEMA U UPHOLSTERED



Swivel upholstered chair, aluminum polished or painted base. Sedia tappezzata girevole, base in alluminio pulita o verniciata.

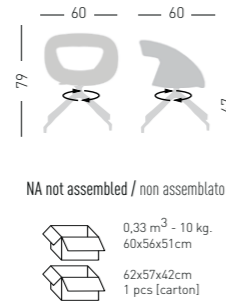

NA not assembled / non assemblato



Frame Finishing & Codes / Finiture Telai e Codici

cod.75.____/IPUB white/bianco	€ 872,00
cod.75.____/IPUN black/nero	€ 872,00
cod.75.____/IPUL polished/lucido	€ 900,00
cod.75.____/IKUB white/bianco	€ 818,00
cod.75.____/IKUN black/nero	€ 818,00
cod.75.____/IKUL polished/lucido	€ 848,00
cod.75.____/IEUB white/bianco	€ 818,00
cod.75.____/IEUN black/nero	€ 818,00
cod.75.____/IEUL polished/lucido	€ 848,00
cod.75./ITCUB white/bianco	€ 796,00
cod.75./ITCUN black/nero	€ 796,00
cod.75./ITCUL polished/lucido	€ 822,00

Felt Glides / Tappi in feltro
Fabric required
Fabbisogno di tessuto
1 pcs: Lin Mtrs 1,5 (h1,40)

COM fabric min. order
10pcs each code
Tessuto cliente TC ordine
min. 10pz per codice

Min. order 4pcs
each code
Ordine min 4pz
per codice

MOEMA UR UPHOLSTERED



Swivel upholstered chair, aluminum polished or painted base with castors. Sedia tappezzata girevole, base in alluminio pulita o verniciata con ruote.

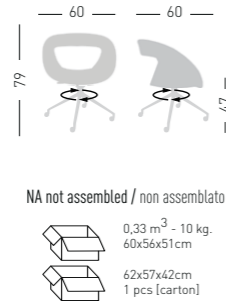

NA not assembled / non assemblato



Frame Finishing & Codes / Finiture Telai e Codici

cod.75.____/IPURB white/bianco	€ 884,00
cod.75.____/IPURN black/nero	€ 884,00
cod.75.____/IPURL polished/lucido	€ 914,00
cod.75.____/IKURB white/bianco	€ 830,00
cod.75.____/IKURN black/nero	€ 830,00
cod.75.____/IKURL polished/lucido	€ 860,00
cod.75.____/IEURB white/bianco	€ 830,00
cod.75.____/IEURN black/nero	€ 830,00
cod.75.____/IEURL polished/lucido	€ 860,00
cod.75./ITCURB white/bianco	€ 808,00
cod.75./ITCURN black/nero	€ 808,00
cod.75./ITCURL polished/lucido	€ 840,00

Fabric required
Fabbisogno di tessuto
1 pcs: Lin Mtrs 1,5 (h1,40)

COM fabric min. order
10pcs each code
Tessuto cliente TC ordine
min. 10pz per codice

Min. order 4pcs
each code
Ordine min 4pz
per codice



Available colors / Colori disponibili

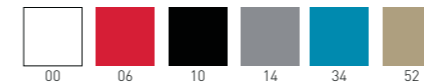

Available colors / Colori disponibili

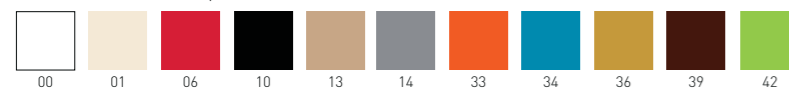

MOON



Techno-polymer chair with co-injected metal frame. Struttura integrale in tecnopolimero con telaio metallico co-iniettato.

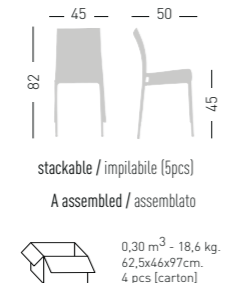

stackable / impilabile (5pcs)

A assembled / assemblato



Frame Finishing & Codes / Finiture Telai e Codici

cod.30.--/A	€ 172,00
cod.30.--/IGN fire retardant / ignifuga	€ 234,00

fire retardand minimum 300 pcs
ignifuga minimo 300 pz

MORE NA



Chromed, white or black painted 4-Legged metal frame; techno-polymer shell. Struttura in metallo 4 gambe, cromata, verniciata bianca o nera; scocca in tecnopolimero.



only for paintend frames
solo per telai verniciati

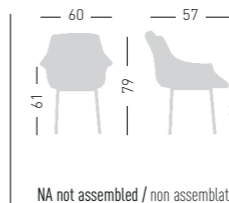

NA not assembled / non assemblato

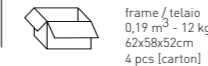

Frame Finishing & Codes / Finiture Telai e Codici

cod.170.--/NA chromed/cromata	€ 232,00
cod.170.--/NAN black painted/verniciato nero	€ 232,00
cod.170.--/NAB white painted/verniciato bianco	€ 232,00

Support and glides white for shells cod. 00-52
Supporto e tappi bianchi per scocche cod. 00-52
Supporto e tappi neri per scocche cod. 06-10-14-34

MORE TC



Chromed or white painted wire steel metal frame, techno-polymer shell. Struttura a traliccio in filo, cromata o verniciata bianca, scocca in tecnopolimero.

only for paintend frames
solo per telai verniciati

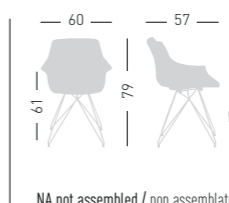

NA not assembled / non assemblato

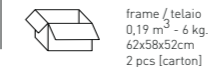

Frame Finishing & Codes / Finiture Telai e Codici

cod.170.--/TC chromed/cromata	€ 218,00
cod.170.--/TCB white painted/verniciato bianco	€ 246,00
cod.170.--/TCN black painted/verniciato nero	€ 246,00

MORE BL



4-Legged wooden beech frame, techno-polymer shell. Struttura in legno di faggio 4 gambe, scocca in tecnopolimero.

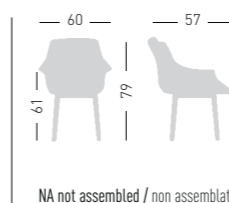

NA not assembled / non assemblato

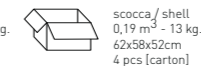

Frame Finishing & Codes / Finiture Telai e Codici

cod.170.--/BLF beech/faggio	€ 430,00
-----------------------------	----------

Felt Glides / Tappi in feltro

MORE ST



Chromed or painted sled steel frame, techno-polymer shell.
Struttura a slitta, cromata o verniciata, scocca in tecnopolimero.



only for painted frames
solo per telai verniciati

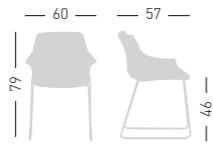

NA not assembled / non assemblato



0,24 m³ - 16 kg.
66x55x63cm
2 pcs [carton]

Frame Finishing & Codes / Finiture Telai e Codici

cod.170.--/ST chromed/cromata
cod.170.--/STB white painted/verniciato bianco
cod.170.--/STN black painted/verniciato nero

€ **202,00**
€ **232,00**
€ **232,00**

MORE 05R



Swivel on 5-spur polished or painted aluminum base, height adjustable, techno-polymer shell.
Girevole su basamento 5 razze in alluminio pulito o verniciato, regolabile in altezza, scocca in tecnopolimero.

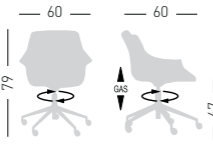

NA not assembled / non assemblato



0,24 m³ - 8,1 kg.
66x55x63cm
1 pcs [carton]

Frame Finishing & Codes / Finiture Telai e Codici

cod.170.--/05R polished/lucida
cod.170.--/05RN black painted/verniciata nera

€ **356,00**
€ **344,00**

MORE U



Swivel on 4-blade aluminum painted base, with glides.
Girevole su basamento verniciato in alluminio a 4 razze su piedini.

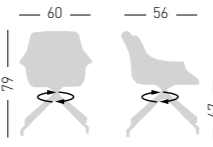

NA not assembled / non assemblato

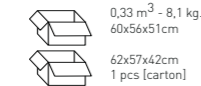

0,33 m³ - 8,1 kg.
60x56x51cm
62x57x42cm
1 pcs [carton]

Frame Finishing & Codes / Finiture Telai e Codici

cod.170.--/UB white/bianca
cod.170.--/UN black/nera

€ **386,00**
€ **386,00**

Felt Glides / Tappi in feltro

MORE UR



Swivel on 4-blade aluminum painted base, with castors.
Girevole su basamento verniciato in alluminio a 4 razze su ruote.

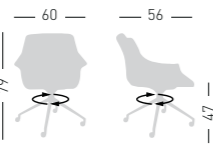

NA not assembled / non assemblato



0,33 m³ - 8,1 kg.
60x56x51cm
62x57x42cm
1 pcs [carton]

Frame Finishing & Codes / Finiture Telai e Codici

cod.170.--/URB white/bianca
cod.170.--/URN black/nera

€ **396,00**
€ **396,00**

MORE CUSHION / CUSCINO



King fabric cushion.
Cuscino in tessuto King.

Available fabric.
Tessuti disponibili.
K



0,060 m³ - 2 kg.
4 pcs [carton]

Frame Finishing & Codes / Finiture Telai e Codici

cod.302.--

€ **392,00**

Fixing clips are always black
I bottoni sono sempre neri

Min. order 4pcs
each code
Ordine min 4pz
per codice

MORE UPHOLSTERED IMBOTTITE

Products follows UNI 9175 -UNI 9175/FA, in terms of Fire Resistance, Fire Reation Class 11M
Prodotto Omologato dal Ministero dell'Interno, secondo la UNI 9175 -UNI 9175/FA, con classe di Reazione al fuoco 11M



Available coverings / Finiture disponibili
King fabric / Tessuto King **K** (4pcs min.)
Aurea eco-leather / Ecopelle aurea **E** (4pcs min.)
Kvadrat fabrics / Tessuti Kvadrat **DK** (4pcs min.)
COM fabric / Tessuto cliente **TC** (10pcs min.)

MORE NA UPHOLSTERED



Upholstered PU-FLEX shell, chromed or painted metal frame.
Scocca in PU-FLEX rivestita, telaio in metallo cromato o verniciato.

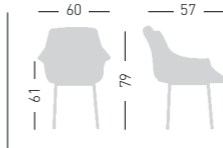

NA not assembled / non assemblato



0,19 m³ - 7 kg.
66x55x63cm
1 pcs [carton]

Frame Finishing & Codes / Finiture Telai e Codici

cod.172.--/IKNA chromed/cromata
cod.172.--/IKNAN black painted/verniciato nero
cod.172.--/IKNAB white painted/verniciato bianco
cod.172.--/IENA chromed/cromata
cod.172.--/IENAN black painted/verniciato nero
cod.172.--/IENAB white painted/verniciato bianco
cod.172.--/IDKNA chromed/cromata
cod.172.--/IDKNAN black painted/verniciato nero
cod.172.--/IDKNAB white painted/verniciato bianco
cod.172./ITCNA chromed/cromata
cod.172./ITCNAN black painted/verniciato nero
cod.172./ITCNAB white painted/verniciato bianco

€ **854,00**
€ **854,00**
€ **854,00**
€ **854,00**
€ **854,00**
€ **1.034,00**
€ **1.034,00**
€ **1.034,00**
€ **790,00**
€ **790,00**
€ **790,00**

Fabric required
Fabbisogno di tessuto
1 pcs: Lin Mtrs 1,3 (h1,40)

COM fabric min. order
10pcs each code
Tessuto cliente TC ordine
min. 10pz per codice

Min. order 4pcs
each code
Ordine min 4pz
per codice

MORE TC UPHOLSTERED



Upholstered PU-FLEX shell, chromed or painted metal frame.
Scocca in PU-FLEX rivestita, telaio in metallo cromato o verniciato.

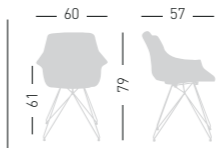

NA not assembled / non assemblato



0,19 m³ - 6 kg.
66x55x63cm
1 pcs [carton]

Frame Finishing & Codes / Finiture Telai e Codici

cod.172.--/IKTC chromed/cromata
cod.172.--/IKTCB white painted/verniciato bianco
cod.172.--/IKTCN black painted/verniciato nero
cod.172.--/IETC chromed/cromata
cod.172.--/IETCB white painted/verniciato bianco
cod.172.--/IETCN black painted/verniciato nero
cod.172.--/IDKTC chromed/cromata
cod.172.--/IDKTCB white painted/verniciato bianco
cod.172.--/IDKTCN black painted/verniciato nero
cod.172./ITCTC chromed/cromata
cod.172./ITCTCB white painted/verniciato bianco
cod.172./ITCTCN black painted/verniciato nero

€ **844,00**
€ **870,00**
€ **870,00**
€ **844,00**
€ **870,00**
€ **870,00**
€ **1.028,00**
€ **1.028,00**
€ **1.028,00**
€ **776,00**
€ **804,00**
€ **804,00**

Fabric required
Fabbisogno di tessuto
1 pcs: Lin Mtrs 1,3 (h1,40)

COM fabric min. order
10pcs each code
Tessuto cliente TC ordine
min. 10pz per codice

Min. order 4pcs
each code
Ordine min 4pz
per codice

MORE BL UPHOLSTERED



Upholstered PU-FLEX shell, wooden beech frame.
Scocca in PU-FLEX rivestita, base in legno faggio.

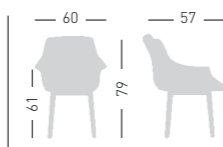

NA not assembled / non assemblato



0,27 m³ - 9 kg.
66x55x63cm
1 pcs [carton]

Frame Finishing & Codes / Finiture Telai e Codici

cod.172.--/IKBLF beech/faggio
cod.172.--/IEBLF beech/faggio
cod.172.--/IDKBLF beech/faggio
cod.172./ITCBLF beech/faggio

€ **1.056,00**
€ **1.056,00**
€ **1.234,00**
€ **988,00**

Felt Glides / Tappi in feltro
Fabric required
Fabbisogno di tessuto
1 pcs: Lin Mtrs 1,3 (h1,40)

COM fabric min. order
10pcs each code
Tessuto cliente TC ordine
min. 10pz per codice

Min. order 4pcs
each code
Ordine min 4pz
per codice

**MORE ST
UPHOLSTERED**



Upholstered PU-FLEX shell,
chromed or painted metal frame.
Scocca in PU-FLEX rivestita,
telai in metallo cromato o verniciato.

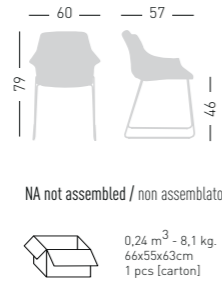

Frame Finishing & Codes / Finiture Telai e Codici

cod.172.--/IKST chromed/cromata	€ 828,00
cod.172.--/IKSTB white painted/verniciato bianco	€ 854,00
cod.172.--/IKSTN black painted/verniciato nero	€ 854,00
cod.172.--/IEST chromed/cromata	€ 828,00
cod.172.--/IESTB white painted/verniciato bianco	€ 854,00
cod.172.--/IESTN black painted/verniciato nero	€ 854,00
cod.172.--/IDKST chromed/cromata	€ 1.008,00
cod.172.--/IDKSTB white painted/verniciato bianco	€ 1.034,00
cod.172.--/IDKSTN black painted/verniciato nero	€ 1.034,00
cod.172./ITCST chromed/cromata	€ 764,00
cod.172./ITCSTB white painted/verniciato bianco	€ 790,00
cod.172./ITCSTN black painted/verniciato nero	€ 790,00

Fabric required

Fabbisogno di tessuto
1 pcs: Lin Mtrs 1,3 (h1,40)

COM fabric min. order
10pcs each code
Tessuto cliente TC ordine
min. 10pz per codice

Min. order 4pcs
each code
Ordine min 4pz
per codice

**MORE O5R
UPHOLSTERED**



Upholstered PU-FLEX shell,
polished or painted aluminum base.
Scocca in PU-FLEX rivestita,
base in alluminio pulito o verniciato.

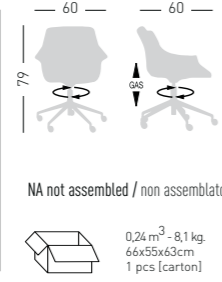

Frame Finishing & Codes / Finiture Telai e Codici

cod.172.--/IKO5R polished/lucida	€ 982,00
cod.172.--/IKO5RN black painted/verniciato nero	€ 968,00
cod.172.--/IEO5R polished/lucida	€ 982,00
cod.172.--/IEO5RN black painted/verniciato nero	€ 968,00
cod.172.--/IDKO5R polished/lucida	€ 1.160,00
cod.172.--/IDKO5RN black painted/verniciato nero	€ 1.146,00
cod.172./ITCO5R polished/lucida	€ 916,00
cod.172./ITCO5RN black painted/verniciato nero	€ 902,00

Fabric required

Fabbisogno di tessuto
1 pcs: Lin Mtrs 1,3 (h1,40)

COM fabric min. order
10pcs each code
Tessuto cliente TC ordine
min. 10pz per codice

Min. order 4pcs
each code
Ordine min 4pz
per codice

**MORE U
UPHOLSTERED**



Upholstered PU-FLEX shell,
polished or painted aluminum base.
Scocca in PU-FLEX rivestita,
base in alluminio pulito o verniciato.

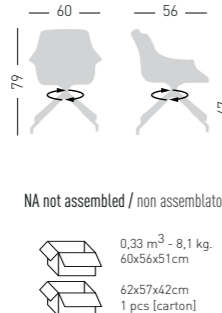

Frame Finishing & Codes / Finiture Telai e Codici

cod.172.--/IKUB white/bianca	€ 1.010,00
cod.172.--/IKUN black/nera	€ 1.010,00
cod.172.--/IKUL polished/lucida	€ 1.034,00
cod.172.--/IEUB white/bianca	€ 1.010,00
cod.172.--/IEUN black/nera	€ 1.010,00
cod.172.--/IEUL polished/lucida	€ 1.034,00
cod.172.--/IDKUB white/bianca	€ 1.188,00
cod.172.--/IDKUN black/nera	€ 1.188,00
cod.172.--/IDKUL polished/lucida	€ 1.212,00
cod.172./ITCUB white/bianca	€ 944,00
cod.172./ITCUN black/nera	€ 944,00
cod.172./ITCUL polished/lucida	€ 968,00

Felt Glides / Tappi in feltro

Fabric required
Fabbisogno di tessuto
1 pcs: Lin Mtrs 1,3 (h1,40)

COM fabric min. order
10pcs each code
Tessuto cliente TC ordine
min. 10pz per codice

Min. order 4pcs
each code
Ordine min 4pz
per codice

**MORE UR
UPHOLSTERED**



Upholstered PU-FLEX shell,
polished or painted aluminum base
with castors.
Scocca in PU-FLEX rivestita, base in
alluminio pulito o verniciato con ruote.

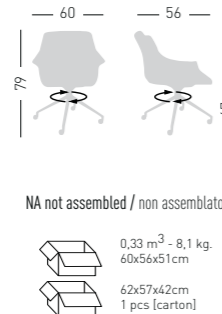

Frame Finishing & Codes / Finiture Telai e Codici

cod.172.--/IKURB white/bianca	€ 1.020,00
cod.172.--/IKURN black/nera	€ 1.020,00
cod.172.--/IKURL polished/lucida	€ 1.048,00
cod.172.--/IEURB white/bianca	€ 1.020,00
cod.172.--/IEURN black/nera	€ 1.020,00
cod.172.--/IEURL polished/lucida	€ 1.048,00
cod.172.--/IDKURB white/bianca	€ 1.202,00
cod.172.--/IDKURN black/nera	€ 1.202,00
cod.172.--/IDKURL polished/lucida	€ 1.228,00
cod.172./ITCURB white/bianca	€ 958,00
cod.172./ITCURN black/nera	€ 958,00
cod.172./ITCURL polished/lucida	€ 982,00

Fabric required

Fabbisogno di tessuto
1 pcs: Lin Mtrs 1,3 (h1,40)

COM fabric min. order
10pcs each code
Tessuto cliente TC ordine
min. 10pz per codice

Min. order 4pcs
each code
Ordine min 4pz
per codice

Ninja



Available colors / Colori disponibili



NINJA NA



Chromed or painted 4-Legged metal
frame, techno-polymer shell.
Struttura in metallo 4 gambe, cromata o
verniciata, scocca in tecnopolimero.



only for painted frames
solo per telai verniciati

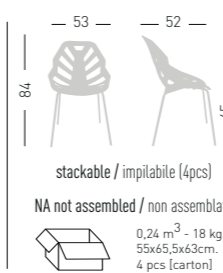

Frame Finishing & Codes / Finiture Telai e Codici

cod.65.--/NA chromed/cromata	€ 134,00
cod.65.--/NAN black painted/verniciato nero	€ 152,00
cod.65.--/NAB white painted/verniciato bianco	€ 152,00

NINJA TC



Chromed or painted wire steel metal
frame, techno-polymer shell.
Struttura a traliccio in filo, cromata o
verniciata, scocca in tecnopolimero.

only for painted frames
solo per telai verniciati

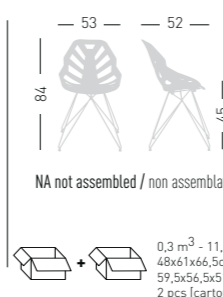

Frame Finishing & Codes / Finiture Telai e Codici

cod.65.--/TC chromed/cromata	€ 152,00
cod.65.--/TCB white painted/verniciato bianco	€ 178,00
cod.65.--/TCN black painted/verniciato nero	€ 178,00

NINJA L



Swivel on 4-spur polished aluminum base, techno-polymer shell.
Girevole su basamento 4 razze in alluminio pulito, scocca in tecnopolimero.



NA not assembled / non assemblato



0,24 m³ - 11 kg.
55x65,5x63cm.
2 pcs [carton]

Frame Finishing & Codes / Finiture Telai e Codici

cod.65.--/L polished/lucida

€ 316,00

Felt Glides / Tappi in feltro

NINJA 5R



Swivel on 5-spur polished aluminum base with castors, height adjustable, techno-polymer shell.
Girevole su basamento 5 razze con ruote in alluminio pulito, regolabile in altezza, scocca in tecnopolimero.

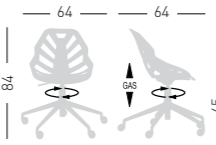

NA not assembled / non assemblato



0,24 m³ - 14 kg.
55x65,5x63cm.
2 pcs [carton]

Frame Finishing & Codes / Finiture Telai e Codici

cod.65.--/5R polished/lucida

€ 316,00



Available colors / Colori disponibili

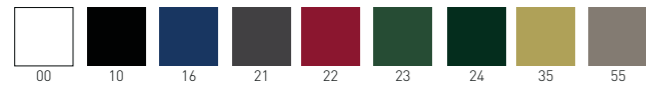

NUTA



4-legged stackable techno-polymer chair.
Sedia impilabile in tecnopolimero.

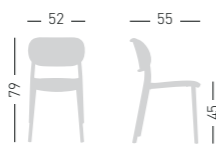

stackable / impilabile (6pcs)

A assembled / assemblato



0,38 m³ - 16 kg.
59x65x99cm
4 pcs [carton]

Frame Finishing & Codes / Finiture Telai e Codici

cod.354.--/A

€ 136,00

NUTA B



4-legged stackable techno-polymer chair with armrests.
Sedia impilabile in tecnopolimero con braccioli.

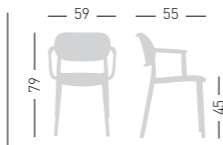

stackable / impilabile (6pcs)

A assembled / assemblato



0,38 m³ - 18 kg.
59x65x99cm
4 pcs [carton]

Frame Finishing & Codes / Finiture Telai e Codici

cod.355.--/A

€ 152,00

NUTA CUSHION / CUSCINO



Upholstered cushion.
Cuscino tappezzato.

Available fabric.
Tessuti disponibili.
K, B, E, DK, MG, TC



Suitable for outdoor purpose with E-MG finishes.
Adatto all'uso per esterni con finiture E-MG.



2 kg.
Inside chairs boxes
Nella scatola delle sedie.
4 pcs [carton]

Frame Finishing & Codes / Finiture Telai e Codici

cod. 327.-- (K)

€ 102,00

cod. 327.-- (E)

€ 102,00

cod. 327.-- (MG)

€ 106,00

cod. 327.-- (B)

€ 110,00

cod. 327.-- (DK)

€ 126,00

cod.327.TC COM fabric/tessuto cliente

€ 88,00

Minimum order 4pcs each code
Ordine minimo 4 pezzi per codice

COM fabric minimum order 10pcs each code
Tessuto cliente TC ordine minimo 10pz per codice

Fabric required / Fabbisogno di tessuto
4 pcs : Lin Mtrs 1 (h1,40)

NUTA BACKREST CUSHION CUSCINO SCHIENALE



Upholstered cushion.
Cuscino tappezzato.

Available fabric.
Tessuti disponibili.
K, B, E, DK, MG, TC



Suitable for outdoor purpose with E-MG finishes.
Adatto all'uso per esterni con finiture E-MG.



2 kg.
Inside chairs boxes
Nella scatola delle sedie.
4 pcs [carton]

Frame Finishing & Codes / Finiture Telai e Codici

cod. 328.-- (K)

€ 102,00

cod. 328.-- (E)

€ 102,00

cod. 328.-- (MG)

€ 106,00

cod. 328.-- (B)

€ 110,00

cod. 328.-- (DK)

€ 126,00

cod. 328.TC COM fabric/tessuto cliente

€ 88,00

Minimum order 4pcs each code
Ordine minimo 4 pezzi per codice

COM fabric minimum order 10pcs each code
Tessuto cliente TC ordine minimo 10pz per codice

Fabric required / Fabbisogno di tessuto
4 pcs : Lin Mtrs 0,5 (h1,40)

Nuta Light



Available frame colors / Colori disponibili telaio

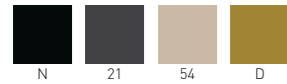

Available coverings / Finiture disponibili
 King fabric / Tessuto King **K** (4pcs min.)
 Maglia fabric / Tessuto Maglia **MG** (4pcs min.)
 Superb Trevira Velvet / Velluto Superb Trevira **S** (4pcs min.)

NUTA LIGHT



Metal frame, padded and upholstered seat and back. Stackable chair. Struttura in metallo a sostegno di sedile e schienale, imbottiti e rivestiti. Sedia impilabile.

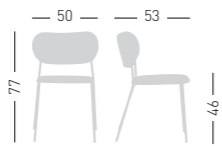

stackable / impilabile (2pcs)
 A assembled / assemblato



0,28 m³ - 10,2 kg.
 59x53x91cm
 2 pcs [carton]

Frame Finishing & Codes / Finiture Telai e Codici

cod. 357._/IKA_
 cod. 357._/IMGA_
 cod. 357._/ISA_

€ 540,00
 € 540,00
 € 540,00

Min. order 4pcs
 each code
 Ordine min 4pz
 per codice

NUTA LIGHT TB



Metal frame, padded and upholstered seat and back. Upholstered armrests. Struttura in metallo a sostegno di sedile e schienale, imbottiti e rivestiti. Braccioli imbottiti e rivestiti.

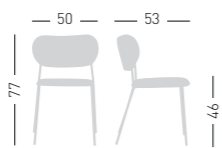

A assembled / assemblato



0,28 m³ - 7,2 kg.
 59x53x91cm
 1 pc [carton]

Frame Finishing & Codes / Finiture Telai e Codici

cod. 358._/IKTB_
 cod. 358._/IMGTB_
 cod. 358._/ISTB_

€ 672,00
 € 672,00
 € 672,00

Min. order 4pcs
 each code
 Ordine min 4pz
 per codice

Armrests and shell's upholstery colours are combined. Il colore del tessuto dei braccioli è abbinato alla scocca.

Open



Available colors / Colori disponibili



OPEN



4-Legged techno polymer chair. Sedia 4 gambe in tecnopolimero.

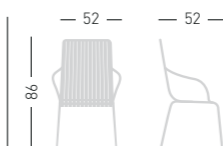

stackable / impilabile (4pcs)
 A assembled / assemblato



0,41 m³ - 20 kg.
 58x72,5x97cm.
 4 pcs [carton]

Frame Finishing & Codes / Finiture Telai e Codici

cod.82.--/A

€ 146,00



Over

Available colors / Colori disponibili

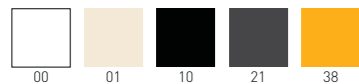

OVER



4-Legged techno-polymer twin-color chair.
Sedia 4 gambe in tecnopolimero bi-colore.

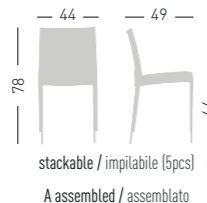

stackable / impilabile (5pcs)
A assembled / assemblato



0,30 m³ - 20,6 kg.
62,5x46x97cm.
4 pcs [carton]

Frame Finishing & Codes / Finiture Telai e Codici

cod.36.--/A

€ 170,00

OVER UPHOLSTERED IMBOTTITE

OVER PLUS



Full techno-polymer frame and seat upholstered in eco-leather.
Struttura integrale in tecnopolimero con seduta imbottita in ecopelle.

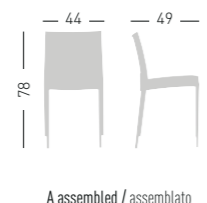

A assembled / assemblato

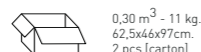

0,30 m³ - 11 kg.
62,5x46x97cm.
2 pcs [carton]

Frame Finishing & Codes / Finiture Telai e Codici

cod.36.--/IEA
cod.36/ITCA

Fabric required
Fabbisogno di tessuto
4 pcs: Lin Mtrs 1 (h1,40)

COM fabric min. order
10pcs each code
Tessuto cliente TC ordine
min. 10pz per codice

Min. order 4pcs
each code
Ordine min 4pz
per codice

€ 202,00
€ 190,00

Available coverings / Finiture disponibili
Eco-leather Aurea / Ecopelle Aurea **E** (4pcs min.)
COM fabric / Tessuto cliente **TC** (10pcs min.)



Panama

Available colors / Colori disponibili



PANAMA



4 legs polymer-steel co-injected structure, techno-polymer shell.
Struttura 4 gambe in co-iniezione metallo-polimero, scocca in tecnopolimero.

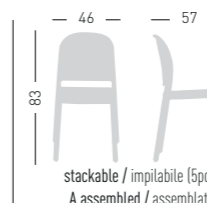

stackable / impilabile (5pcs)
A assembled / assemblato



0,38 m³ - 18 kg.
50x73x102cm.
4 pcs [carton]

Frame Finishing & Codes / Finiture Telai e Codici

cod.240.--/A

€ 190,00

Min. order 4pcs
each code
Ordine min 4pz
per codice

PANAMA ARMREST / BRACCIOLO



4 legs polymer-steel co-injected structure, techno-polymer shell with armrests.
Struttura 4 gambe in co-iniezione metallo-polimero, scocca in tecnopolimero con braccioli.

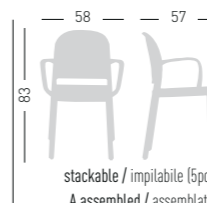

stackable / impilabile (5pcs)
A assembled / assemblato



0,45 m³ - 20 kg.
58x75x102cm.
4 pcs [carton]

Frame Finishing & Codes / Finiture Telai e Codici

cod.241.--/A

€ 272,00

Min. order 4pcs
each code
Ordine min 4pz
per codice

PANAMA BL

4-Legged wooden beech frame, techno-polymer shell.
Struttura in legno di faggio 4 gambe, scocca in tecnopolimero.

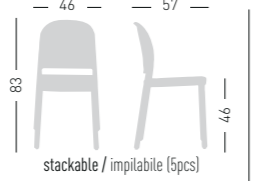
stackable / impilabile (5pcs)
A assembled / assemblato



0,38 m³ - 18 kg.
50x73x102cm.
4 pcs [carton]

Frame Finishing & Codes / Finiture Telai e Codici
cod.240.--/BL_

Felt Glides / Tappi in feltro

€ **256,00**

Min. order 4pcs each code
Ordine min 4pz per codice

Price + € 20,00

F RN

PANAMA BL ARMREST / BRACCIOLO

4-Legged wooden beech frame, techno-polymer shell with armrests.
Struttura in legno di faggio 4 gambe, scocca in tecnopolimero con braccioli.

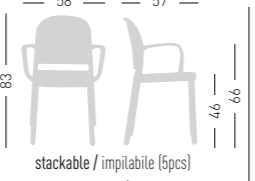
stackable / impilabile (5pcs)
A assembled / assemblato



0,45 m³ - 20,4 kg.
58x75x102cm.
4 pcs [carton]

Frame Finishing & Codes / Finiture Telai e Codici
cod.241.--/BL_

Felt Glides / Tappi in feltro

€ **324,00**



Min. order 4pcs each code
Ordine min 4pz per codice

Price + € 20,00

F RN

PANAMA CUSHION / CUSCINO

Eco-leather Aurea or King fabric cushion.
Cuscino in ecopelle Aurea o tessuto King.

0,060 m³ - 2 kg.
4 pcs [carton]

Frame Finishing & Codes / Finiture Telai e Codici
cod.303.-- seat/sedile
cod.304.-- back/schienale

It is possible to order the seat cushion only if coupled to the chair
Cuscino sedile ordinabile solo se accoppiato alla sedia

€ **126,00**
€ **126,00**

COM fabric min. order 10pcs each code
Tessuto cliente TC ordine min. 10pz per codice

Min. order 4pcs each code
Ordine min 4pz per codice

Available fabric.
Tessuti disponibili.
E, K



Panky is the modular and customisable seating system for furnishing waiting and reception areas, based on the 2027 trestle frame that allows it to be combined with operational office furnishings. The creation of a Panky configuration entails 3 simple steps, shown hereafter: choose the frame, available in 3 lengths; compose the sofa with cushions, cushions with back and/or armrest, tops; and finally join up the composition with 45° or 90° connections, whether composed of service tops or cushions.

Panky è il sistema di sedute modulare e personalizzabile per arredare gli spazi dedicati all'attesa e all'accoglienza, basato sulla struttura a cavalletto 2027 che consente l'abbinamento con gli arredi operativi dell'ufficio. La creazione di una configurazione si svolge in 3 semplici step, riportati di seguito: scegliere la struttura, disponibile in 3 lunghezze; comporre il divano con cuscini, cuscini con schienale e/o bracciolo, piani; ed infine collegare la composizione con connessioni a 45° o 90°, siano esse realizzate con piani di servizio o cuscini.

Finishings / Finiture

Frame colors / Colori struttura



Laminated Top Color / Colore Piano Laminato

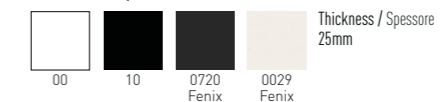

Available coverings / Finiture disponibili
King fabric / Tessuto King **K**
Aurea eco-leather / Ecopelle Aurea **E**
Blazer fabric / Tessuto Blazer **B**
Leather / Pelle **P**
Kvadrat fabrics / Tessuti Kvadrat **DK**
COM fabric / Tessuto cliente **TC**

PANKY TWO SEATER STRUCTURE
STRUTTURA A DUE UNITÀ PANKY



Frame colors / Colori struttura

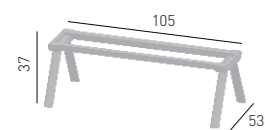

NA not assembled / non assemblato



Frame Finishing & Codes / Finiture Telai e Codici

cod. PK2P_

€ **602,00**

PANKY THREE SEATER STRUCTURE
STRUTTURA A TRE UNITÀ PANKY



Frame colors / Colori struttura

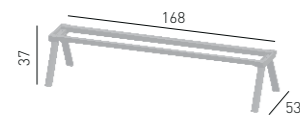

NA not assembled / non assemblato



Frame Finishing & Codes / Finiture Telai e Codici

cod. PK3P_

€ **732,00**

PANKY FOUR SEATER STRUCTURE
STRUTTURA A QUATTRO UNITÀ PANKY



Frame colors / Colori struttura

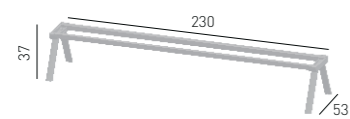

NA not assembled / non assemblato



Frame Finishing & Codes / Finiture Telai e Codici

cod. PK4P_

€ **828,00**

PANKY SEAT MODULE
MODULO SEDUTA PANKY

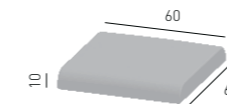

Available coverings / Finiture disponibili
King fabric / Tessuto King **K**
Aurea eco-leather / Ecopelle Aurea **E**
Blazer fabric / Tessuto Blazer **B**
Leather / Pelle **P**
Kvadrat fabrics / Tessuti Kvadrat **DK**
COM fabric / Tessuto cliente **TC**

Finishing & Codes / Finiture e Codici

cod. 401_/_IK
cod. 401_/_IE
cod. 401_/_IB
cod. 401_/_IP
cod. 401_/_IDK
cod. 401_/_ITC

€ **420,00**
€ **420,00**
€ **492,00**
€ **566,00**
€ **566,00**
€ **378,00**

Fabric required
Fabbisogno di tessuto
1 pcs: Lin Mtrs 0,85 (h1,40)

PANKY SEAT WITH BACK MODULE
MODULO SEDUTA CON SCHIENALE PANKY

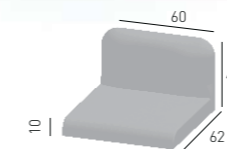

Available coverings / Finiture disponibili
King fabric / Tessuto King **K**
Aurea eco-leather / Ecopelle Aurea **E**
Blazer fabric / Tessuto Blazer **B**
Leather / Pelle **P**
Kvadrat fabrics / Tessuti Kvadrat **DK**
COM fabric / Tessuto cliente **TC**

Finishing & Codes / Finiture e Codici

cod. 402_/_IK
cod. 402_/_IE
cod. 402_/_IB
cod. 402_/_IP
cod. 402_/_IDK
cod. 402_/_ITC

€ **770,00**
€ **770,00**
€ **908,00**
€ **982,00**
€ **982,00**
€ **678,00**

Fabric required
Fabbisogno di tessuto
1 pcs: Lin Mtrs 1,5 (h1,40)

PANKY SEAT WITH BACK & LEFT ARMREST
MODULO SEDUTA CON SCHIENALE E BRACCIOLO SX PANKY

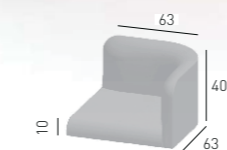

Available coverings / Finiture disponibili
King fabric / Tessuto King **K**
Aurea eco-leather / Ecopelle Aurea **E**
Blazer fabric / Tessuto Blazer **B**
Leather / Pelle **P**
Kvadrat fabrics / Tessuti Kvadrat **DK**
COM fabric / Tessuto cliente **TC**

Finishing & Codes / Finiture e Codici

cod. 403_/_IK
cod. 403_/_IE
cod. 403_/_IB
cod. 403_/_IP
cod. 403_/_IDK
cod. 403_/_ITC

€ **1.054,00**
€ **1.054,00**
€ **1.200,00**
€ **1.344,00**
€ **1.344,00**
€ **944,00**

Fabric required
Fabbisogno di tessuto
1 pcs: Lin Mtrs 2 (h1,40)

PANKY SEAT WITH BACK & RIGHT ARMREST
MODULO SEDUTA CON SCHIENALE E BRACCIOLO DX PANKY

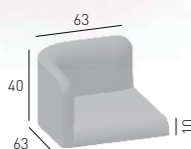

0,18 m³ - 13 kg.
1 pcs [carton]

Available coverings / Finiture disponibili
King fabric / Tessuto King **K**
Aurea eco-leather / Ecopelle Aurea **E**
Blazer fabric / Tessuto Blazer **B**
Leather / Pelle **P**
Kvadrat fabrics / Tessuti Kvadrat **DK**
COM fabric / Tessuto cliente **TC**

Finishing & Codes / Finiture e Codici

cod. 404.____/IK	€	1.054,00
cod. 404.____/IE	€	1.054,00
cod. 404.____/IB	€	1.200,00
cod. 404.____/IP	€	1.344,00
cod. 404.____/IDK	€	1.344,00
cod. 404/ITC	€	944,00

Fabric required
Fabbisogno di tessuto
1 pcs: Lin Mtrs 2 (h1,40)

PANKY SQUARE TABLE
MODULO TAVOLINO QUADRATO PANKY

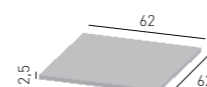
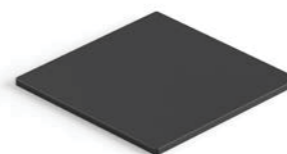

0,05 m³ - 4 kg.
1 pcs [carton]

Square Laminated table top.
Top Tavolino in Laminato quadrato.

Top Color / Colore Piano

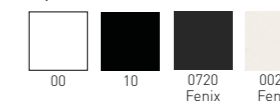

Finishing & Codes / Finiture e Codici

Cod. PTL154.____ laminated	€	174,00
Cod. PTL454.____ lam.fenix	€	218,00

PANKY 90° ANGULAR SEAT
MODULO SEDUTA ANGOLARE 90° PANKY

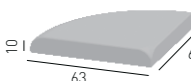

0,05 m³ - 6 kg.
1 pcs [carton]

Available coverings / Finiture disponibili
King fabric / Tessuto King **K**
Aurea eco-leather / Ecopelle Aurea **E**
Blazer fabric / Tessuto Blazer **B**
Leather / Pelle **P**
Kvadrat fabrics / Tessuti Kvadrat **DK**
COM fabric / Tessuto cliente **TC**

Finishing & Codes / Finiture e Codici

cod. 405.____/IK	€	414,00
cod. 405.____/IE	€	414,00
cod. 405.____/IB	€	486,00
cod. 405.____/IP	€	558,00
cod. 405.____/IDK	€	558,00
cod. 405/ITC	€	380,00

Fabric required
Fabbisogno di tessuto
1 pcs: Lin Mtrs 0,85 (h1,40)

PANKY 90° ANGULAR TABLE
MODULO TAVOLINO ANGOLARE 90° PANKY

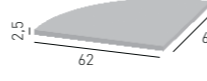

0,05 m³ - 3,5 kg.
1 pcs [carton]

90° angular Laminated table top.
Top Tavolino in Laminato angolare a 90°.

Top Color / Colore Piano

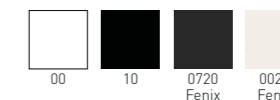

Finishing & Codes / Finiture e Codici

Cod. PTL158.____ laminated	€	256,00
Cod. PTL458.____ lam.fenix	€	328,00

PANKY 45° ANGULAR SEAT
MODULO SEDUTA ANGOLARE 45°

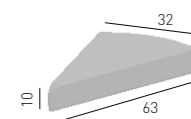

0,05 m³ - 4 kg.
1 pcs [carton]

Available coverings / Finiture disponibili
King fabric / Tessuto King **K**
Aurea eco-leather / Ecopelle Aurea **E**
Blazer fabric / Tessuto Blazer **B**
Leather / Pelle **P**
Kvadrat fabrics / Tessuti Kvadrat **DK**
COM fabric / Tessuto cliente **TC**

Finishing & Codes / Finiture e Codici

cod. 406.____/IK	€	370,00
cod. 406.____/IE	€	370,00
cod. 406.____/IB	€	442,00
cod. 406.____/IP	€	514,00
cod. 406.____/IDK	€	514,00
cod. 406/ITC	€	332,00

Fabric required
Fabbisogno di tessuto
1 pcs: Lin Mtrs 0,80 (h1,40)

PANKY 45° ANGULAR TABLE
MODULO TAVOLINO ANGOLARE 45° PANKY



0,05 m³ - 3 kg.
1 pcs [carton]

45° angular Laminated table top.
Top Tavolino in Laminato angolare a 45°.

Top Color / Colore Piano

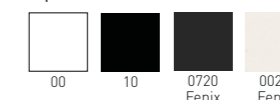

Finishing & Codes / Finiture e Codici

Cod. PTL159.____ laminated	€	256,00
Cod. PTL459.____ lam.fenix	€	328,00

PANKY 90° ANGULAR CONNECTION
MODULO CONNETTORE ANGOLARE 90° PANKY

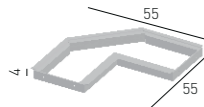

0,05 m³ - 3 kg.
1 pcs [carton]

Panky steel angular frame 90°.
Struttura in acciaio angolare a 90° Panky.

Frame colors / Colori struttura



Frame Finishing & Codes / Finiture Telai e Codici

Cod. PK90A. __

€ 436,00

PANKY 45° ANGULAR CONNECTION
MODULO CONNETTORE ANGOLARE 45° PANKY

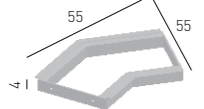

0,05 m³ - 2,8 kg.
1 pcs [carton]

Panky steel angular frame 45°.
Struttura in acciaio angolare a 45° Panky.

Frame colors / Colori struttura



Frame Finishing & Codes / Finiture Telai e Codici

Cod. PK45A. __

€ 364,00

Place



Products follows UNI 9175 -UNI 9175/FA, in terms of Fire Resistance, Fire Reation Class 1M
Prodotto Omologato dal Ministero dell'Interno, secondo la UNI 9175 -UNI 9175/FA, con classe di Reazione al fuoco 1M



Available coverings / Finiture disponibili
Aurea eco-leather / Ecopelle aurea **E**
King fabric / Tessuto King **K**
Kvadrat fabrics / Tessuti Kvadrat **DK**
COM fabric / Tessuto cliente **TC** (10pcs min.)

Grand Place Collection can be customized on demand.
La collezione Grand Place può essere personalizzata su richiesta.

PLACE

Eco-leather or fabric upholsterd armchair, painted frame.
Poltrona rivestita in eco-pelle o tessuto, struttura in metallo verniciato.

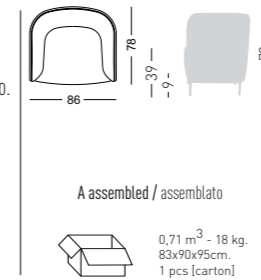

A assembled / assemblato



0,71 m³ - 18 kg.
83x90x95cm.
1 pcs [carton]

Frame Finishing & Codes / Finiture Telai e Codici

cod.280.--/IEAN black painted/verniciato nero	€ 1.846,00
cod.280.--/IEAB white painted/verniciato bianco	€ 1.846,00
cod.280.--/IKAN black painted/verniciato nero	€ 1.846,00
cod.280.--/IKAB white painted/verniciato bianco	€ 1.846,00
cod.280.--/IDKAN black painted/verniciato nero	€ 2.416,00
cod.280.--/IDKAB white painted/verniciato bianco	€ 2.416,00
cod.280/ITCAN black painted/verniciato nero	€ 1.714,00
cod.280/ITCAB white painted/verniciato bianco	€ 1.714,00

Fabric required
Fabbisogno di tessuto
1 pcs: Lin Mtrs 4 (h1,40)

COM fabric min. order
10pcs each code
Tessuto cliente TC ordine
min. 10pz per codice

PLACE SOFA

Eco-leather or fabric upholsterd sofa, painted frame.
Divano rivestito in eco-pelle o tessuto, struttura in metallo verniciato.

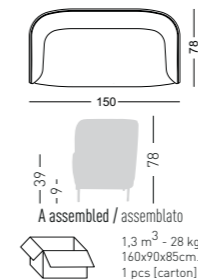

A assembled / assemblato



1,3 m³ - 28 kg.
160x90x85cm.
1 pcs [carton]

Frame Finishing & Codes / Finiture Telai e Codici

cod.281.--/IEAN black painted/verniciato nero	€ 2.448,00
cod.281.--/IEAB white painted/verniciato bianco	€ 2.448,00
cod.281.--/IKAN black painted/verniciato nero	€ 2.448,00
cod.281.--/IKAB white painted/verniciato bianco	€ 2.448,00
cod.281.--/IDKAN black painted/verniciato nero	€ 3.262,00
cod.281.--/IDKAB white painted/verniciato bianco	€ 3.262,00
cod.281/ITCAN black painted/verniciato nero	€ 2.266,00
cod.281/ITCAB white painted/verniciato bianco	€ 2.266,00

Fabric required
Fabbisogno di tessuto
1 pcs: Lin Mtrs 5 (h1,40)

COM fabric min. order
10pcs each code
Tessuto cliente TC ordine
min. 10pz per codice

SMALL PLACE

Eco-leather or fabric upholsterd mini tub, painted frame.
Poltroncina rivestita in eco-pelle o tessuto, struttura in metallo verniciato.

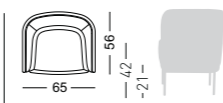

A assembled / assemblato



0,38 m³ - 12 kg.
69x69x80cm.
1 pcs [carton]

Frame Finishing & Codes / Finiture Telai e Codici

cod.282.--/IEAN black painted/verniciato nero	€ 1.256,00
cod.282.--/IEAB white painted/verniciato bianco	€ 1.256,00
cod.282.--/IKAN black painted/verniciato nero	€ 1.256,00
cod.282.--/IKAB white painted/verniciato bianco	€ 1.256,00
cod.282.--/IDKAN black painted/verniciato nero	€ 1.504,00
cod.282.--/IDKAB white painted/verniciato bianco	€ 1.504,00
cod.282/ITCAN black painted/verniciato nero	€ 1.140,00
cod.282/ITCAB white painted/verniciato bianco	€ 1.140,00

Fabric required
Fabbisogno di tessuto
1 pcs: Lin Mtrs 2 (h1,40)

COM fabric min. order
10pcs each code
Tessuto cliente TC ordine
min. 10pz per codice

SMALL PLACE WOOD



Eco-leather or fabric upholstered mini tub, wooden frame.
Poltroncina rivestita in eco-pelle o tessuto, struttura in legno.

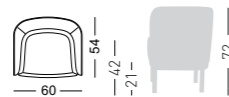

A assembled / assemblato



Frame Finishing & Codes / Finiture Telai e Codici

cod.282.--/IEBLF	€	1.404,00
cod.282.--/IKBLF	€	1.404,00
cod.282.--/IDKBLF	€	1.686,00
cod.282/ITCBLF	€	1.288,00

Fabric required
Fabbisogno di tessuto
1 pcs: Lin Mtrs 2 (h1,40)

COM fabric min. order
10pcs each code
Tessuto cliente TC ordine
min. 10pz per codice

GRAND PLACE KIT 1



Seating modular system KIT 1
Sistema di sedute modulare KIT 1

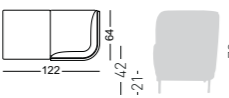

NA not assembled / non assemblato

Frame Finishing & Codes / Finiture Telai e Codici

cod.285.K01.--/IENAN black painted/verniciato nero	€	2.128,00
cod.285.K01.--/IENAB white painted/verniciato bianco	€	2.128,00
cod.285.K01.--/IKNAN black painted/verniciato nero	€	2.128,00
cod.285.K01.--/IKNAB white painted/verniciato bianco	€	2.128,00
cod.285.K01.--/IDKNAN black painted/verniciato nero	€	2.470,00
cod.285.K01.--/IDKNAB white painted/verniciato bianco	€	2.470,00
cod.285.K01/ITCNAN black painted/verniciato nero	€	1.990,00
cod.285.K01/ITCNAB white painted/verniciato bianco	€	1.990,00

Fabric required
Fabbisogno di tessuto
1 pcs: Lin Mtrs 2,1 (h1,40)

COM fabric min. order
10pcs each code
Tessuto cliente TC ordine
min. 10pz per codice

GRAND PLACE KIT 4



Seating modular system KIT 4
Sistema di sedute modulare KIT 4

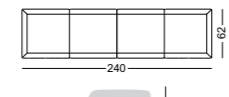

NA not assembled / non assemblato

Frame Finishing & Codes / Finiture Telai e Codici

cod.285.K04.--/IENAN black painted/verniciato nero	€	2.276,00
cod.285.K04.--/IENAB white painted/verniciato bianco	€	2.276,00
cod.285.K04.--/IKNAN black painted/verniciato nero	€	2.276,00
cod.285.K04.--/IKNAB white painted/verniciato bianco	€	2.276,00
cod.285.K04.--/IDKNAN black painted/verniciato nero	€	2.728,00
cod.285.K04.--/IDKNAB white painted/verniciato bianco	€	2.728,00
cod.285.K04/ITCNAN black painted/verniciato nero	€	2.032,00
cod.285.K04/ITCNAB white painted/verniciato bianco	€	2.032,00

Fabric required
Fabbisogno di tessuto
1 pcs: Lin Mtrs 3,6 (h1,40)

COM fabric min. order
10pcs each code
Tessuto cliente TC ordine
min. 10pz per codice

GRAND PLACE KIT 5



Seating modular system KIT 5
Sistema di sedute modulare KIT 5

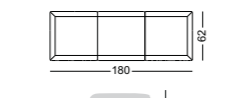

NA not assembled / non assemblato

Frame Finishing & Codes / Finiture Telai e Codici

cod.285.K05.--/IENAN black painted/verniciato nero	€	1.822,00
cod.285.K05.--/IENAB white painted/verniciato bianco	€	1.822,00
cod.285.K05.--/IKNAN black painted/verniciato nero	€	1.822,00
cod.285.K05.--/IKNAB white painted/verniciato bianco	€	1.822,00
cod.285.K05.--/IDKNAN black painted/verniciato nero	€	2.162,00
cod.285.K05.--/IDKNAB white painted/verniciato bianco	€	2.162,00
cod.285.K05/ITCNAN black painted/verniciato nero	€	1.636,00
cod.285.K05/ITCNAB white painted/verniciato bianco	€	1.636,00

Fabric required
Fabbisogno di tessuto
1 pcs: Lin Mtrs 2,8 (h1,40)

COM fabric min. order
10pcs each code
Tessuto cliente TC ordine
min. 10pz per codice

GRAND PLACE KIT 6



Seating modular system KIT 6
Sistema di sedute modulare KIT 6

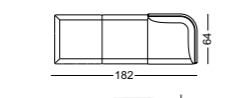

NA not assembled / non assemblato

Frame Finishing & Codes / Finiture Telai e Codici

cod.285.K06.--/IENAN black painted/verniciato nero	€	2.650,00
cod.285.K06.--/IENAB white painted/verniciato bianco	€	2.650,00
cod.285.K06.--/IKNAN black painted/verniciato nero	€	2.650,00
cod.285.K06.--/IKNAB white painted/verniciato bianco	€	2.650,00
cod.285.K06.--/IDKNAN black painted/verniciato nero	€	3.082,00
cod.285.K06.--/IDKNAB white painted/verniciato bianco	€	3.082,00
cod.285.K06/ITCNAN black painted/verniciato nero	€	2.390,00
cod.285.K06/ITCNAB white painted/verniciato bianco	€	2.390,00

Fabric required
Fabbisogno di tessuto
1 pcs: Lin Mtrs 4 (h1,40)

COM fabric min. order
10pcs each code
Tessuto cliente TC ordine
min. 10pz per codice

GRAND PLACE KIT 7



Seating modular system KIT 7
Sistema di sedute modulare KIT 7

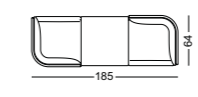

NA not assembled / non assemblato

Frame Finishing & Codes / Finiture Telai e Codici

cod.285.K07.--/IENAN black painted/verniciato nero	€	3.484,00
cod.285.K07.--/IENAB white painted/verniciato bianco	€	3.484,00
cod.285.K07.--/IKNAN black painted/verniciato nero	€	3.484,00
cod.285.K07.--/IKNAB white painted/verniciato bianco	€	3.484,00
cod.285.K07.--/IDKNAN black painted/verniciato nero	€	4.180,00
cod.285.K07.--/IDKNAB white painted/verniciato bianco	€	4.180,00
cod.285.K07/ITCNAN black painted/verniciato nero	€	3.194,00
cod.285.K07/ITCNAB white painted/verniciato bianco	€	3.194,00

Fabric required
Fabbisogno di tessuto
1 pcs: Lin Mtrs 4,5 (h1,40)

COM fabric min. order
10pcs each code
Tessuto cliente TC ordine
min. 10pz per codice

GRAND PLACE KIT 8



Seating modular system KIT 8
Sistema di sedute modulare KIT 8

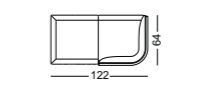

NA not assembled / non assemblato

Frame Finishing & Codes / Finiture Telai e Codici

cod.285.K08.--/IENAN black painted/verniciato nero	€	2.050,00
cod.285.K08.--/IENAB white painted/verniciato bianco	€	2.050,00
cod.285.K08.--/IKNAN black painted/verniciato nero	€	2.050,00
cod.285.K08.--/IKNAB white painted/verniciato bianco	€	2.050,00
cod.285.K08.--/IDKNAN black painted/verniciato nero	€	2.458,00
cod.285.K08.--/IDKNAB white painted/verniciato bianco	€	2.458,00
cod.285.K08/ITCNAN black painted/verniciato nero	€	1.850,00
cod.285.K08/ITCNAB white painted/verniciato bianco	€	1.850,00

Fabric required
Fabbisogno di tessuto
1 pcs: Lin Mtrs 3 (h1,40)

COM fabric min. order
10pcs each code
Tessuto cliente TC ordine
min. 10pz per codice

GRAND PLACE KIT 9



Seating modular system KIT 9
Sistema di sedute modulare KIT 9

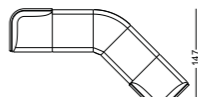

NA not assembled / non assemblato

Frame Finishing & Codes / Finiture Telai e Codici

cod.285.K09.--/IENAN black painted/verniciato nero	€	4.380,00
cod.285.K09.--/IENAB white painted/verniciato bianco	€	4.380,00
cod.285.K09.--/IKNAN black painted/verniciato nero	€	4.380,00
cod.285.K09.--/IKNAB white painted/verniciato bianco	€	4.380,00
cod.285.K09.--/IDKNAN black painted/verniciato nero	€	5.256,00
cod.285.K09.--/IDKNAB white painted/verniciato bianco	€	5.256,00
cod.285.K09/ITCNAN black painted/verniciato nero	€	3.926,00
cod.285.K09/ITCNAB white painted/verniciato bianco	€	3.926,00

Fabric required
Fabbisogno di tessuto
1 pcs: Lin Mtrs 6,9 (h1,40)

COM fabric min. order
10pcs each code
Tessuto cliente TC ordine
min. 10pz per codice

GRAND PLACE KIT 10



Seating modular system KIT 10
Sistema di sedute modulare KIT 10

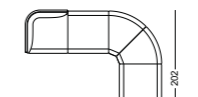

NA not assembled / non assemblato

Frame Finishing & Codes / Finiture Telai e Codici

cod.285.K10.--/IENAN black painted/verniciato nero	€	4.894,00
cod.285.K10.--/IENAB white painted/verniciato bianco	€	4.894,00
cod.285.K10.--/IKNAN black painted/verniciato nero	€	4.894,00
cod.285.K10.--/IKNAB white painted/verniciato bianco	€	4.894,00
cod.285.K10.--/IDKNAN black painted/verniciato nero	€	5.870,00
cod.285.K10.--/IDKNAB white painted/verniciato bianco	€	5.870,00
cod.285.K10/ITCNAN black painted/verniciato nero	€	4.388,00
cod.285.K10/ITCNAB white painted/verniciato bianco	€	4.388,00

Fabric required
Fabbisogno di tessuto
1 pcs: Lin Mtrs 7,7 (h1,40)

COM fabric min. order
10pcs each code
Tessuto cliente TC ordine
min. 10pz per codice

GRAND PLACE KIT 11

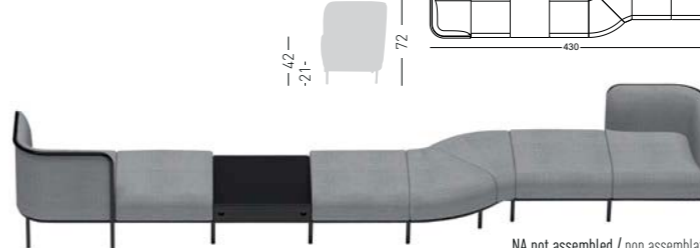

Seating modular system KIT 11
Sistema di sedute modulare KIT 11

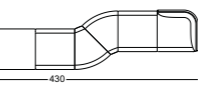

NA not assembled / non assemblato

Frame Finishing & Codes / Finiture Telai e Codici

cod.285.K11.--/IENAN black painted/verniciato nero	€	6.680,00
cod.285.K11.--/IENAB white painted/verniciato bianco	€	6.680,00
cod.285.K11.--/IKNAN black painted/verniciato nero	€	6.680,00
cod.285.K11.--/IKNAB white painted/verniciato bianco	€	6.680,00
cod.285.K11.--/IDKNAN black painted/verniciato nero	€	8.016,00
cod.285.K11.--/IDKNAB white painted/verniciato bianco	€	8.016,00
cod.285.K11/ITCNAN black painted/verniciato nero	€	6.098,00
cod.285.K11/ITCNAB white painted/verniciato bianco	€	6.098,00

Fabric required
Fabbisogno di tessuto
1 pcs: Lin Mtrs 8,5 (h1,40)

COM fabric min. order
10pcs each code
Tessuto cliente TC ordine
min. 10pz per codice

GRAND PLACE KIT 12

Seating modular system KIT 12
Sistema di sedute modulare KIT 12

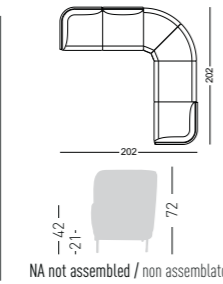

Frame Finishing & Codes / Finiture Telai e Codici

cod.285.K12.--/IENAN black painted/verniciato nero	€	5.320,00
cod.285.K12.--/IENAB white painted/verniciato bianco	€	5.320,00
cod.285.K12.--/IKNAN black painted/verniciato nero	€	5.320,00
cod.285.K12.--/IKNAB white painted/verniciato bianco	€	5.320,00
cod.285.K12.--/IDKNAN black painted/verniciato nero	€	6.292,00
cod.285.K12.--/IDKNAB white painted/verniciato bianco	€	6.292,00
cod.285.K12/ITCNAN black painted/verniciato nero	€	4.804,00
cod.285.K12/ITCNAB white painted/verniciato bianco	€	4.804,00

Fabric required
Fabbisogno di tessuto
1 pcs: Lin Mtrs 8 (h1,40)

COM fabric min. order
10pcs each code
Tessuto cliente TC ordine
min. 10pz per codice



Prisma

Available colors / Colori disponibili

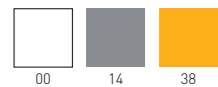

PRISMA

4-Legged techno-polymer chair.
Sedia 4 gambe in tecnopolimero.

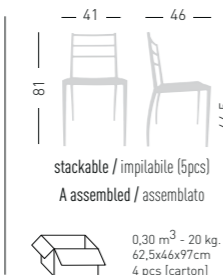

Frame Finishing & Codes / Finiture Telai e Codici

cod.40.--/A	€	162,00
--------------------	---	---------------



Prodige

Available colors / Colori disponibili

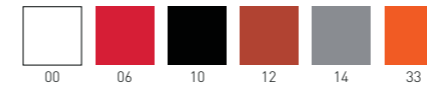

PRODIGE NA

Chromed or painted 4-Legged metal frame, techno-polymer shell.
Struttura in metallo 4 gambe, cromata o verniciata, scocca in tecnopolimero.

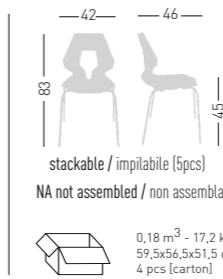

Frame Finishing & Codes / Finiture Telai e Codici

cod.55.--/NA chromed/cromata	€	148,00
cod.55.--/NAN black painted/verniciato nero	€	178,00
cod.55.--/NAB white painted/verniciato bianco	€	178,00

PRODIGE 5R

Swivel on 5-spur polished aluminum base with castors, height adjustable, techno-polymer shell.
Girevole su basamento 5 razze in alluminio pulito con ruote, regolabile in altezza, scocca in tecnopolimero.

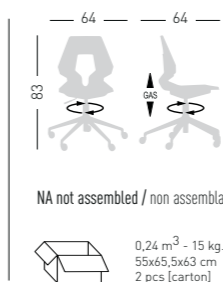

Frame Finishing & Codes / Finiture Telai e Codici

cod.55.--/5R polished/lucida	€	404,00
-------------------------------------	---	---------------

Sanela



Available rope color / Colori disponibili corda



Frame available colors / Colori disponibili struttura



SANELA

4-Legged metal frame, painted with special treatment for outdoor purpose, with wrapped rope.
Telaio 4 gambe in metallo verniciato con trattamento per esterno, con intreccio artigianale di corda.

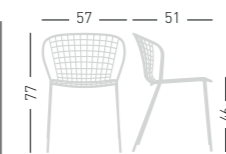

A assembled / assemblato



Frame Finishing & Codes / Finiture Telaio e Codici

cod. 270_(I)/A_

€ 726,00

Min. order 20pcs
each code
Ordine min 20pz
per codice

SANELA B

4-Legged metal frame with armrest, painted with treatment for outdoor purpose, with wrapped rope.
Telaio 4 gambe con braccioli in metallo verniciato con trattamento per esterno, con intreccio artigianale di corda.

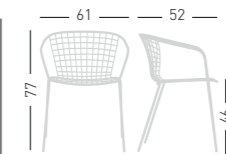

A assembled / assemblato

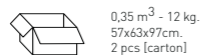

Frame Finishing & Codes / Finiture Telaio e Codici

cod. 271_(I)/A_

€ 858,00

Min. order 20pcs
each code
Ordine min 20pz
per codice

SANELA LOUNGE

4-Legged metal lounge armchair, painted with special treatment for outdoor purpose, with wrapped rope.
Poltrona lounge con struttura 4 gambe in metallo verniciato con trattamento per esterno, con intreccio artigianale di corda.

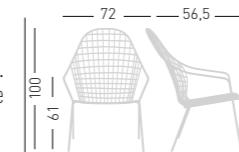

A assembled / assemblato



Frame Finishing & Codes / Finiture Telaio e Codici

cod. 277_(I)/A_

€ 1.574,00

Min. order 10pcs
each code
Ordine min 10pz
per codice

SANELA ROCKING LOUNGE

Relaxing rocking version, featuring rope, wrapped around an aerial metal structure provided with natural oak rockers.
Versione a dondolo, realizzata con una struttura aerea in metallo, dall'intreccio artigianale della corda e da pattini in legno di rovere naturale.

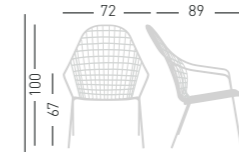

A assembled / assemblato



Frame Finishing & Codes / Finiture Telaio e Codici

cod. 277_(I)/A_DRN

€ 2.036,00

Min. order 10pcs
each code
Ordine min 10pz
per codice

SANELA POUF

Footrest pouf with painted metal structure with outdoor treatment, with wrapped rope.
Pouf poggiapiedi con struttura in metallo verniciato con trattamento per esterno, con intreccio artigianale di corda.

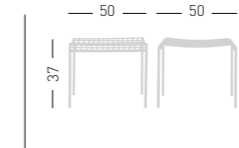

A assembled / assemblato



Frame Finishing & Codes / Finiture Telaio e Codici

cod. 278_(I)/A_

€ 540,00

Min. order 10pcs
each code
Ordine min 10pz
per codice

SANELA BENCH

Twin-seater metal bench, painted with special treatment for outdoor purpose, with wrapped rope.
Panca 2 posti con struttura in metallo verniciato con trattamento per esterno, con intreccio artigianale di corda.

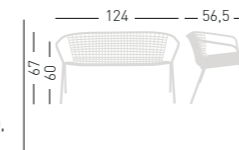

A assembled / assemblato



Frame Finishing & Codes / Finiture Telaio e Codici

cod. 279_(I)/A_

€ 2.420,00

Min. order 10pcs
each code
Ordine min 10pz
per codice



Serena

Available colors / Colori disponibili

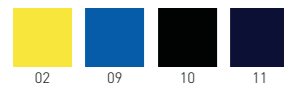

IGN Versions follows UNI 9177 certification in terms of Fire Resistance, Fire Reaction Class 1
Versioni IGN prodotto Omologato con Classe di Reazione al fuoco 1, UNI 9177



SERENA

Seat and back in techno-polymer, anodized aluminum legs.
Seduta e schienale in tecnopolimero e gambe in alluminio anodizzato.



stackable / impilabile (4pcs)
A assembled / assemblato



Frame Finishing & Codes / Finiture Telai e Codici

cod.10.--/A assembled/assemblata
cod.10.--/NA not assembled/non assemblata
cod.10.--/IGN fire retardant / ignifuga

fire retardant minimum 300 pcs
ignifuga minimo 300 pz

NA not assembled / non assemblato



€ 148,00
€ 134,00
€ 216,00



Slot Fill

Available colors / Colori disponibili

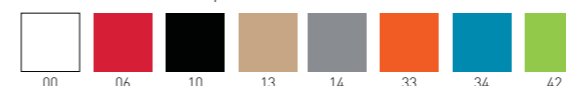

IGN Versions follows UNI 9177 certification in terms of Fire Resistance, Fire Reaction Class 1
Versioni IGN prodotto Omologato con Classe di Reazione al fuoco 1, UNI 9177



SLOT FILL NA

Chromed or painted 4-Legged metal frame, techno-polymer shell.
Struttura in metallo 4 gambe, cromata o verniciata, scocca in tecnopolimero.



only for painted frames
solo per telai verniciati

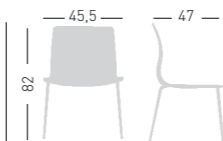

stackable / impilabile (4pcs)
NA not assembled / non assemblato



Frame Finishing & Codes / Finiture Telai e Codici

cod.174.--/NA chromed/cromata
cod.174.--/NAB white painted/verniciato bianco
cod.174.--/NAN black painted/verniciato nero

cod.174.--/IGN
fire retardant, chromed frame
ignifuga, telaio cromato
Minimum order 300pcs/ Ordine minimo 300pz

€ 166,00
€ 196,00
€ 196,00

€ 218,00

SLOT FILL TB

Chromed or painted 4-Legged metal frame with armrests, techno-polymer shell.
Struttura in metallo 4 gambe con braccioli, cromata o verniciata, scocca in tecnopolimero.



only for painted frames
solo per telai verniciati

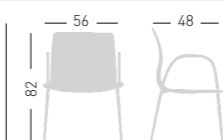

stackable / impilabile (4pcs)
NA not assembled / non assemblato



Frame Finishing & Codes / Finiture Telai e Codici

cod.174.--/TB chromed/cromata
cod.174.--/TBB white painted/verniciato bianco
cod.174.--/TBN black painted/verniciato nero

€ 190,00
€ 222,00
€ 222,00

SLOT FILL BL

4-Legged wooden beech frame, techno-polymer shell.
Struttura in legno di faggio 4 gambe, scocca in tecnopolimero.

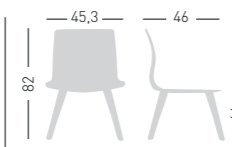

NA not assembled / non assemblato



Frame Finishing & Codes / Finiture Telai e Codici

cod.174.--/BL_

€ **316,00**

Felt Glides / Tappi in feltro

SLOT FILL TC

Chromed or painted wire steel metal frame, techno-polymer shell.
Struttura a traliccio in filo, cromata o verniciata, scocca in tecnopolimero.



only for painted frames
solo per telai verniciati

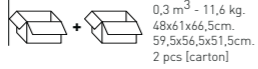
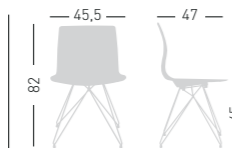

Frame Finishing & Codes / Finiture Telai e Codici

cod.174.--/TC chromed/cromata
cod.174.--/TCB white painted/verniciato bianco
cod.174.--/TCN black painted/verniciato nero

€ **190,00**
€ **222,00**
€ **222,00**

SLOT FILL S

Chromed or painted wire steel sled frame, techno-polymer shell.
Struttura a slitta in filo, cromata o verniciata, scocca in tecnopolimero.



only for painted frames
solo per telai verniciati

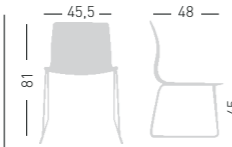

stackable / impilabile (8pcs)

NA not assembled / non assemblato



Frame Finishing & Codes / Finiture Telai e Codici

cod.174.--/S chromed/cromata
cod.174.--/SB white painted/verniciato bianco
cod.174.--/SN black painted/verniciato nero

€ **166,00**
€ **196,00**
€ **196,00**

SLOT FILL O5R

Swivel on 5-spur polished aluminum base, height adjustable, techno-polymer shell.
Girevole su basamento 5 razze in alluminio pulito, regolabile in altezza, scocca in tecnopolimero.

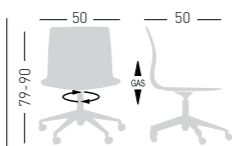

NA not assembled / non assemblato



Frame Finishing & Codes / Finiture Telai e Codici

cod.174.--/O5R polished/lucida
cod.174.--/O5RN black painted/verniciata nera

€ **356,00**
€ **342,00**

SLOT FILL U

Swivel on 4-blade aluminum painted base, with glides.
Girevole su basamento verniciato in alluminio a 4 razze su piedini.

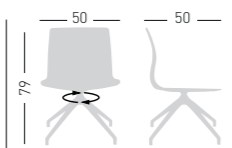

NA not assembled / non assemblato



Frame Finishing & Codes / Finiture Telai e Codici

cod.174.--/UB white/bianca
cod.174.--/UN black/nera

€ **370,00**
€ **370,00**

Felt Glides / Tappi in feltro

SLOT FILL UR

Swivel on 4-blade aluminum painted base, with castors.
Girevole su basamento verniciato in alluminio a 4 razze su ruote.

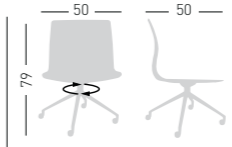

NA not assembled / non assemblato



Frame Finishing & Codes / Finiture Telai e Codici

cod.174.--/URB white/bianca
cod.174.--/URN black/nera

€ **380,00**
€ **380,00**

SLOT FILL PG

2-3-4-5 seat benches, metal-polymer co-injected legs, techno-polymer shell.
Panca a 2-3-4-5 posti, gambe co-iniettate in metallo-polimero, scocca in tecnopolimero.



NA not assembled / non assemblato



0,28 m³ - 18,5 kg,
1 pcs [carton]

0,29 m³ - 24 kg,
1 pcs [carton]

0,30 m³ - 28,5 kg,
1 pcs [carton]

0,31 m³ - 34 kg,
1 pcs [carton]

Frame Finishing & Codes / Finiture Telai e Codici

cod.174.--/PG2P-- (100 cm)
cod.174.--/PG3P-- (150 cm)
cod.174.--/PG4P-- (200 cm)
cod.174.--/PG5P-- (250 cm)

€ **584,00**
€ **658,00**
€ **732,00**
€ **808,00**

Legs and shells colors can be combined.
It is possible to change a seat with a grey metal top.
Outdoor version on request.
I colori delle gambe possono essere abbinati alla scocca.
È possibile sostituire la seduta con un tavolino in metallo grigio.
Versione per esterni su richiesta.

SLOT FILL CUSHION / CUSCINO

Upholstered cushion.
Cuscino tappezzato.



Available fabric.
Tessuti disponibili.
B, E, K, DK

Frame Finishing & Codes / Finiture Telai e Codici

cod.308.-- (B)
cod.308.-- (E)
cod.308.-- (K)
cod.308.-- (DK)
cod.308.TC COM fabric/tessuto cliente

€ **122,00**
€ **106,00**
€ **106,00**
€ **130,00**
€ **92,00**

Fabric required
Fabbisogno di tessuto
4 pcs: Lin Mtrs 1 (h,1,40)

COM fabric min. order
10pcs each code
Tessuto cliente TC ordine
min. 10pz per codice

Min. order 4pcs
each code
Ordine min 4pz
per codice

SLOT FILL CONNECTING SYSTEM GANCIO CONNESSIONE

Set linking glides for in-line disposal.
Set piedini con agganci per disporre le sedute in linea.



Assembled / assemblato

Frame Finishing & Codes / Finiture Telai e Codici

cod.1012

€ **20,00**

available for models: S
disponibile per versioni: S

SLOT FILL CHAIRS TROLLEY CARRELLO PER SEDIE

Trolley for chairs, chromed metal structure.
Carrello porta sedie, struttura in metallo cromato.

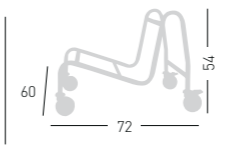

Frame Finishing & Codes / Finiture Telai e Codici

cod.2000/A

€ **242,00**

available for models: S
disponibile per versioni: S

stackable on trolley 18 pcs
impilabili su carrello 18 pcs

max height with 18 chairs 188 cm
altezza carrello con 18 sedie 188 cm

**SLOT FILL
CHAIRS TROLLEY
CARRELLO PER SEDIE**



Painted grey adjustable Dolly, for 4 legged chairs.
Carrello per sedie 4 gambe, regolabile, verniciato grigio.

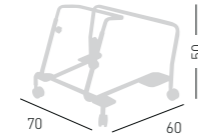

Frame Finishing & Codes / Finiture Telai e Codici

cod.2001/A

available for models: NA
disponibile per versioni: NA

€ **290,00**



0,3 m³ - 8kg
62x72x51cm.
1 pcs (carton)

SLOT UPHOLSTERED IMBOTTITE

Available coverings / Finiture disponibili
Aurea eco-leather / Ecopelle aurea **E** (4pcs min.)
King fabric / Tessuto King **K** (4pcs min.)
Blazer fabric / Tessuto blazer **B** (4pcs min.)
Kvadrat fabrics / Tessuti Kvadrat **DK** (4pcs min.)
COM fabric / Tessuto cliente **TC** (10pcs min.)

**SLOT M NA
UPHOLSTERED**



Fabric or leather upholstered chair,
chromed or painted frame.
Sedia imbottita in tessuto o pelle,
telaio in metallo cromato o verniciato.

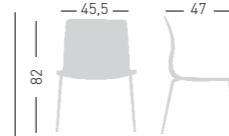

NA not assembled / non assemblato



0,24 m³ - 13 kg.
55x65,5x63cm.
2 pcs (carton)

Frame Finishing & Codes / Finiture Telai e Codici

cod.173.--/IENA chromed/cromata	€	448,00
cod.173.--/IENAB white/bianco	€	476,00
cod.173.--/IENAN black/nero	€	476,00
cod.173.--/IKNA chromed/cromata	€	448,00
cod.173.--/IKNAB white/bianco	€	476,00
cod.173.--/IKNAN black/nero	€	476,00
cod.173.--/IBNA chromed/cromata	€	500,00
cod.173.--/IBNAB white/bianco	€	530,00
cod.173.--/IBNAN black/nero	€	530,00
cod.173.--/IDKNA chromed/cromata	€	584,00
cod.173.--/IDKNAB white/bianco	€	610,00
cod.173.--/IDKNAN black/nero	€	610,00
cod.173/ITCNA chromed/cromata	€	396,00
cod.173/ITCNAB white/bianco	€	424,00
cod.173/ITCNAN black/nero	€	424,00

Fabric required
Fabbisogno di tessuto
1 pcs: Lin Mtrs 1,04 (h1,40)

COM fabric min. order
10pcs each code
Tessuto cliente TC ordine
min. 10pz per codice

Min. order 4pcs
each code
Ordine min 4pz
per codice

**SLOT M BL
UPHOLSTERED**



Fabric or leather upholstered chair,
wooden beech base.
Sedia imbottita in tessuto o pelle,
telaio in legno di faggio.



NA not assembled / non assemblato



0,24 m³ - 13 kg.
55x65,5x63cm.
2 pcs (carton)

Frame Finishing & Codes / Finiture Telai e Codici

cod.173.--/IEBL_	€	522,00
cod.173.--/IKBL_	€	522,00
cod.173.--/IBBL_	€	586,00
cod.173.--/IDKBL_	€	632,00
cod.173/ITCBL_	€	468,00

Felt Glides / Tappi in feltro
Fabric required
Fabbisogno di tessuto
1 pcs: Lin Mtrs 1,04 (h1,40)

COM fabric min. order
10pcs each code
Tessuto cliente TC ordine
min. 10pz per codice

Min. order 4pcs
each code
Ordine min 4pz
per codice



Price + € 20,00

**SLOT M TB
UPHOLSTERED**



Fabric or leather upholstered chair,
chromed or painted frame with arms.
Sedia imbottita in tessuto o pelle,
telaio in metallo cromato o verniciato
con braccioli.

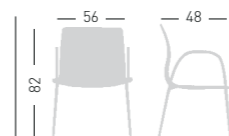

NA not assembled / non assemblato



0,24 m³ - 13,6 kg.
60x65x75cm.
2 pcs (carton)

Frame Finishing & Codes / Finiture Telai e Codici

cod.173.--/IETB chromed/cromata	€	478,00
cod.173.--/IETBB white/bianco	€	500,00
cod.173.--/IETBN black/nero	€	500,00
cod.173.--/IKTB chromed/cromata	€	478,00
cod.173.--/IKTBB white/bianco	€	500,00
cod.173.--/IKTBN black/nero	€	500,00
cod.173.--/IBTB chromed/cromata	€	530,00
cod.173.--/IBTBB white/bianco	€	554,00
cod.173.--/IBTBN black/nero	€	554,00
cod.173.--/IDKTB chromed/cromata	€	612,00
cod.173.--/IDKTBB white/bianco	€	634,00
cod.173.--/IDKTBN black/nero	€	634,00
cod.173/ITCTB chromed/cromata	€	426,00
cod.173/ITCTBB white/bianco	€	448,00
cod.173/ITCTBN black/nero	€	448,00

Fabric required
Fabbisogno di tessuto
1 pcs: Lin Mtrs 1,04 (h1,40)

COM fabric min. order
10pcs each code
Tessuto cliente TC ordine
min. 10pz per codice

Min. order 4pcs
each code
Ordine min 4pz
per codice

SLOT M TC UPHOLSTERED



Fabric or leather upholstered chair, chromed or painted frame.
Sedia imbottita in tessuto o pelle, telaio in metallo cromato o verniciato.

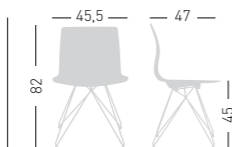

NA not assembled / non assemblato

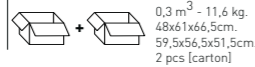

Frame Finishing & Codes / Finiture Telai e Codici

cod.173.--/IETC chromed/cromata	€ 438,00
cod.173.--/IETCB white/bianco	€ 500,00
cod.173.--/IETCN black/nero	€ 500,00
cod.173.--/IKTC chromed/cromata	€ 468,00
cod.173.--/IKTCB white/bianco	€ 500,00
cod.173.--/IKTCN black/nero	€ 500,00
cod.173.--/IBTC chromed/cromata	€ 524,00
cod.173.--/IBTCB white/bianco	€ 554,00
cod.173.--/IBTCN black/nero	€ 554,00
cod.173.--/IDKTC chromed/cromata	€ 606,00
cod.173.--/IDKTCB white/bianco	€ 634,00
cod.173.--/IDKTCN black/nero	€ 634,00
cod.173./ITCTC chromed/cromata	€ 418,00
cod.173./ITCTCB white/bianco	€ 448,00
cod.173./ITCTCN black/nero	€ 448,00

Fabric required
Fabbisogno di tessuto
1 pcs: Lin Mtrs 1,04 (h1,40)

COM fabric min. order
10pcs each code
Tessuto cliente TC ordine
min. 10pz per codice

Min. order 4pcs
each code
Ordine min 4pz
per codice

SLOT M S UPHOLSTERED



Fabric or leather upholstered chair, chromed or painted frame.
Sedia imbottita in tessuto o pelle, telaio in metallo cromato o verniciato.



NA not assembled / non assemblato



Frame Finishing & Codes / Finiture Telai e Codici

cod.173.--/IES chromed/cromata	€ 448,00
cod.173.--/IESB white/bianco	€ 476,00
cod.173.--/IESN black/nero	€ 476,00
cod.173.--/IKS chromed/cromata	€ 448,00
cod.173.--/IKSB white/bianco	€ 476,00
cod.173.--/IKSN black/nero	€ 476,00
cod.173.--/IBS chromed/cromata	€ 500,00
cod.173.--/IBSB white/bianco	€ 530,00
cod.173.--/IBSN black/nero	€ 530,00
cod.173.--/IDKS chromed/cromata	€ 584,00
cod.173.--/IDKSB white/bianco	€ 610,00
cod.173.--/IDKSN black/nero	€ 610,00
cod.173./ITCS chromed/cromata	€ 396,00
cod.173./ITCSB white/bianco	€ 424,00
cod.173./ITCSN black/nero	€ 424,00

Fabric required
Fabbisogno di tessuto
1 pcs: Lin Mtrs 1,04 (h1,40)

COM fabric min. order
10pcs each code
Tessuto cliente TC ordine
min. 10pz per codice

Min. order 4pcs
each code
Ordine min 4pz
per codice

SLOT 05R UPHOLSTERED



Fabric or leather upholstered chair, aluminum polished or painted base.
Sedia imbottita in tessuto o pelle, base in alluminio pulito o verniciato.

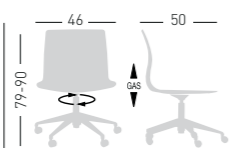

NA not assembled / non assemblato



Frame Finishing & Codes / Finiture Telai e Codici

cod.173.--/IEO5R polished/lucida	€ 622,00
cod.173.--/IEO5RN black painted/verniciata nera	€ 598,00
cod.173.--/IKO5R polished/lucida	€ 622,00
cod.173.--/IKO5RN black painted/verniciata nera	€ 598,00
cod.173.--/IBO5R polished/lucida	€ 676,00
cod.173.--/IBO5RN black painted/verniciata nera	€ 652,00
cod.173.--/IDK05R polished/lucida	€ 756,00
cod.173.--/IDK05RN black painted/verniciata nera	€ 732,00
cod.173./ITC05R polished/lucida	€ 572,00
cod.173./ITC05RN black painted/verniciata nera	€ 548,00

Fabric required
Fabbisogno di tessuto
1 pcs: Lin Mtrs 1,04 (h1,40)

COM fabric min. order
10pcs each code
Tessuto cliente TC ordine
min. 10pz per codice

Min. order 4pcs
each code
Ordine min 4pz
per codice

SLOT U UPHOLSTERED



Fabric or leather upholstered chair, aluminum polished or painted base.
Sedia imbottita in tessuto o pelle, base in alluminio pulito o verniciato.

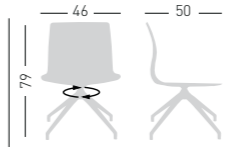

NA not assembled / non assemblato

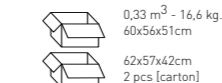

Frame Finishing & Codes / Finiture Telai e Codici

cod.173.--/IEUB white/bianco	€ 652,00
cod.173.--/IEUN black/nera	€ 652,00
cod.173.--/IEUL polished/lucida	€ 676,00
cod.173.--/IKUB white/bianco	€ 652,00
cod.173.--/IKUN black/nera	€ 652,00
cod.173.--/IKUL polished/lucida	€ 676,00
cod.173.--/IBUB white/bianco	€ 704,00
cod.173.--/IBUN black/nera	€ 704,00
cod.173.--/IBUL polished/lucida	€ 728,00
cod.173.--/IDKUB white/bianco	€ 788,00
cod.173.--/IDKUN black/nera	€ 788,00
cod.173.--/IDKUL polished/lucida	€ 812,00
cod.173./ITCUB white/bianco	€ 600,00
cod.173./ITCUN black/nera	€ 600,00
cod.173./ITCUL polished/lucida	€ 624,00

Felt Glides / Tappi in feltro
Fabric required
Fabbisogno di tessuto
1 pcs: Lin Mtrs 1,04 (h1,40)

COM fabric min. order
10pcs each code
Tessuto cliente TC ordine
min. 10pz per codice

Min. order 4pcs
each code
Ordine min 4pz
per codice

SLOT UR UPHOLSTERED



Fabric or leather upholstered chair, aluminum polished or painted base with castors.
Sedia imbottita in tessuto o pelle, base in alluminio pulito o verniciato con ruote.

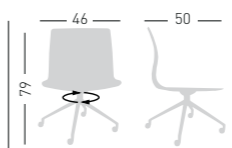

NA not assembled / non assemblato

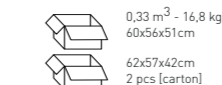

Frame Finishing & Codes / Finiture Telai e Codici

cod.173.--/IEURB white/bianco	€ 660,00
cod.173.--/IEURN black/nera	€ 660,00
cod.173.--/IEURL polished/lucida	€ 686,00
cod.173.--/IKURB white/bianco	€ 660,00
cod.173.--/IKURN black/nera	€ 660,00
cod.173.--/IKURL polished/lucida	€ 686,00
cod.173.--/IBURB white/bianco	€ 716,00
cod.173.--/IBURN black/nera	€ 716,00
cod.173.--/IBURL polished/lucida	€ 742,00
cod.173.--/IDKURB white/bianco	€ 796,00
cod.173.--/IDKURN black/nera	€ 796,00
cod.173.--/IDKURL polished/lucida	€ 822,00
cod.173./ITCURB white/bianco	€ 610,00
cod.173./ITCURN black/nera	€ 610,00
cod.173./ITCURL polished/lucida	€ 636,00

Fabric required
Fabbisogno di tessuto
1 pcs: Lin Mtrs 1,04 (h1,40)

COM fabric min. order
10pcs each code
Tessuto cliente TC ordine
min. 10pz per codice

Min. order 4pcs
each code
Ordine min 4pz
per codice

SLOT PG UPHOLSTERED



Upholstered shell and co-injected metal-polymer legs, painted bench frame.
Sedia con scocca tappezzata e struttura co-iniettata metallo-polimero, telaio panca verniciato.



NA not assembled / non assemblato

Frame Finishing & Codes / Finiture Telai e Codici

(100 cm) 0,28 m³ - 20 kg. 1 pcs (carton)	cod.173.--/IEPG2P.-- (100 cm)	€ 1.186,00
(150 cm) 0,29 m³ - 26 kg. 1 pcs (carton)	cod.173.--/IEPG3P.-- (150 cm)	€ 1.254,00
(200 cm) 0,30 m³ - 31 kg. 1 pcs (carton)	cod.173.--/IEPG4P.-- (200 cm)	€ 1.316,00
(250 cm) 0,31 m³ - 37 kg. 1 pcs (carton)	cod.173.--/IEPG5P.-- (250 cm)	€ 1.392,00
(100 cm)	cod.173.--/IKPG2P.-- (100 cm)	€ 1.186,00
(150 cm)	cod.173.--/IKPG3P.-- (150 cm)	€ 1.254,00
(200 cm)	cod.173.--/IKPG4P.-- (200 cm)	€ 1.316,00
(250 cm)	cod.173.--/IKPG5P.-- (250 cm)	€ 1.392,00
(100 cm)	cod.173.--/IBPG2P.-- (100 cm)	€ 1.254,00
(150 cm)	cod.173.--/IBPG3P.-- (150 cm)	€ 1.422,00
(200 cm)	cod.173.--/IBPG4P.-- (200 cm)	€ 1.588,00
(250 cm)	cod.173.--/IBPG5P.-- (250 cm)	€ 1.760,00
(100 cm)	cod.173.--/IDKPG2P.-- (100 cm)	€ 1.456,00
(150 cm)	cod.173.--/IDKPG3P.-- (150 cm)	€ 1.662,00
(200 cm)	cod.173.--/IDKPG4P.-- (200 cm)	€ 1.860,00
(250 cm)	cod.173.--/IDKPG5P.-- (250 cm)	€ 2.060,00
(100 cm)	cod.173./ITCPG2P.-- (100 cm)	€ 1.084,00
(150 cm)	cod.173./ITCPG3P.-- (150 cm)	€ 1.102,00
(200 cm)	cod.173./ITCPG4P.-- (200 cm)	€ 1.114,00
(250 cm)	cod.173./ITCPG5P.-- (250 cm)	€ 1.128,00

It is possible to change a seat with grey metal top.
È possibile sostituire la seduta con un tavolino grigio in metallo.

Bench legs available colors
Colori disponibili gambe panca
00-06-10-13-14-33-34-42

Fabric required
Fabbisogno di tessuto
1 pcs: Lin Mtrs 1,04 (h1,40)

**SLOT L GL
UPHOLSTERED**



Fabric or leather upholstered shell, wooden beech base.
Sedia imbottita in tessuto o pelle, telaio in legno di faggio.

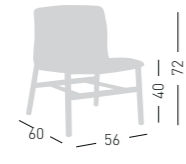

A assembled / assemblato



0,40 m³ - 8,5 kg.
100x66x60cm.
1 pcs (carton)

Frame Finishing & Codes / Finiture Telai e Codici

cod.251.--/IEGLF beech/faggio	€ 794,00
cod.251.--/IKGLF beech/faggio	€ 794,00
cod.251.--/IBGLF beech/faggio	€ 878,00
cod.251.--/DKGLF beech/faggio	€ 928,00
cod.251/ITCGLF beech/faggio	€ 778,00

Felt Glides / Tappi in feltro

Fabric required
Fabbisogno di tessuto
1 pcs: Lin Mtrs 1,1 (h1,40)

COM fabric min. order
10pcs each code
Tessuto cliente TC ordine
min. 10pz per codice

Min. order 4pcs
each code
Ordine min 4pz
per codice

**SLOT L S
UPHOLSTERED**



Fabric or leather upholstered shell, chromed or painted frame.
Sedia imbottita in tessuto o pelle, telaio in metallo cromato o verniciato.

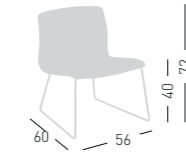

A assembled / assemblato



0,40 m³ - 9,5 kg.
100x66x60cm.
1 pcs (carton)

Frame Finishing & Codes / Finiture Telai e Codici

cod.251.--/IES chromed/cromata	€ 788,00
cod.251.--/IESB white/bianco	€ 788,00
cod.251.--/IKS chromed/cromata	€ 768,00
cod.251.--/IKSB white/bianco	€ 788,00
cod.251.--/IBS chromed/cromata	€ 854,00
cod.251.--/IBSB white/bianco	€ 878,00
cod.251.--/DKS chromed/cromata	€ 902,00
cod.251.--/DKSB white/bianco	€ 928,00
cod.251/ITCS chromed/cromata	€ 752,00
cod.251/ITCSB white/bianco	€ 778,00

Fabric required
Fabbisogno di tessuto
1 pcs: Lin Mtrs 1,1 (h1,40)

COM fabric min. order
10pcs each code
Tessuto cliente TC ordine
min. 10pz per codice

Min. order 4pcs
each code
Ordine min 4pz
per codice

**SLOT XL GL
UPHOLSTERED**



Fabric or leather upholstered shell, wooden beech base.
Sedia imbottita in tessuto o pelle, telaio in legno di faggio.

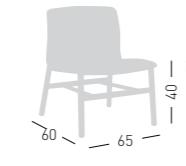

A assembled / assemblato



0,40 m³ - 9 kg.
100x66x60cm.
1 pcs (carton)

Frame Finishing & Codes / Finiture Telai e Codici

cod.252.--/IEGLF beech/faggio	€ 870,00
cod.252.--/IKGLF beech/faggio	€ 870,00
cod.252.--/IBGLF beech/faggio	€ 928,00
cod.252.--/DKGLF beech/faggio	€ 1.006,00
cod.252/ITCGLF beech/faggio	€ 854,00

Felt Glides / Tappi in feltro

Fabric required
Fabbisogno di tessuto
1 pcs: Lin Mtrs 1,1 (h1,40)

COM fabric min. order
10pcs each code
Tessuto cliente TC ordine
min. 10pz per codice

Min. order 4pcs
each code
Ordine min 4pz
per codice

**SLOT XL S
UPHOLSTERED**



Fabric or leather upholstered shell, chromed or painted frame.
Sedia imbottita in tessuto o pelle, telaio in metallo cromato o verniciato.

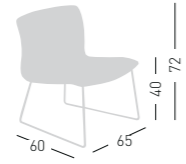

A assembled / assemblato



0,40 m³ - 10,5 kg.
100x66x60cm.
1 pcs (carton)

Frame Finishing & Codes / Finiture Telai e Codici

cod.252.--/IES chromed/cromata	€ 794,00
cod.252.--/IESB white/bianco	€ 870,00
cod.252.--/IKS chromed/cromata	€ 794,00
cod.252.--/IKSB white/bianco	€ 870,00
cod.252.--/IBS chromed/cromata	€ 878,00
cod.252.--/IBSB white/bianco	€ 928,00
cod.252.--/DKS chromed/cromata	€ 928,00
cod.252.--/DKSB white/bianco	€ 1.006,00
cod.252/ITCS chromed/cromata	€ 774,00
cod.252/ITCSB white/bianco	€ 854,00

Fabric required
Fabbisogno di tessuto
1 pcs: Lin Mtrs 1,1 (h1,40)

COM fabric min. order
10pcs each code
Tessuto cliente TC ordine
min. 10pz per codice

Min. order 4pcs
each code
Ordine min 4pz
per codice



Frame colors / Colori struttura



SOCIAL-IZE 2027



Modular upholstered seating unit, part of the "2027" system, painted aluminum-steel frame support, techno-polymer and metal co-injected joint.
Seduta imbottita modulare, parte del sistema "2027", telaio di supporto in alluminio e acciaio, giunti in acciaio co-iniettati in tecnopolimero.

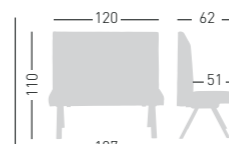

A assembled / assemblato



1,3 m³ - 48 kg.
140x90x85cm.
2 pcs (carton)

Frame Finishing & Codes / Finiture Telai e Codici

cod.264.--/IEPK	€ 2.052,00
cod.264.--/IKPK	€ 2.052,00
cod.264.--/IBPK	€ 2.352,00
cod.264.--/ISPK	€ 2.352,00
cod.264.--/IDKPK	€ 2.572,00
cod.264.--/IPPK	€ 2.572,00
cod.264.--/IMGPK	€ 2.178,00
cod.264./ITCPK COM fabric/tessuto cliente	€ 1.878,00

Fabric required
Fabbisogno di tessuto
1 pcs: Lin Mtrs 2,5 (h1,40)

COM fabric min. order
10pcs each code
Tessuto cliente TC ordine
min. 10pz per codice

Min. order 2pcs
each code
Ordine min 2pz
per codice

Available coverings / Finiture disponibili
Aurea eco-leather / Ecopelle aurea **E** (2pcs min.)
King fabric / Tessuto King **K** (2pcs min.)
Blazer fabric / Tessuto Blazer **B** (2pcs min.)
Superb Trevira Velvet / Velluto Superb Trevira **S** (2pcs min.)
Kvadrat fabrics / Tessuti Kvadrat **DK** (2pcs min.)
Leather / Pelle **P** (2pcs min.)
Maglia fabric / Tessuto Maglia **MG** (2pcs min.)
COM fabric / Tessuto cliente **TC** (10pcs min.)



Available colors / Colori disponibili

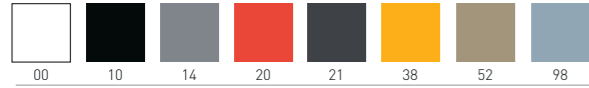

SPYKER

4-legged stackable techno-polymer chair.
Sedia impilabile in tecnopolimero.

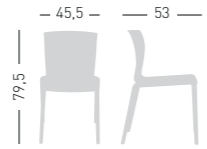

stackable / impilabile (6pcs)
A assembled / assemblato



0,38 m³ - 14,8 kg.
59x75x99cm.
4 pcs [carton]

Frame Finishing & Codes / Finiture Telai e Codici

cod. 225.-- /A

€ 126,00

SPYKER B

4-legged stackable techno-polymer chair with armrests.
Sedia impilabile in tecnopolimero con braccioli.

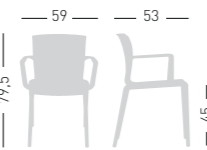

stackable / impilabile (6pcs)
A assembled / assemblato



0,43 m³ - 18,8 kg.
59x75x99cm.
4 pcs [carton]

Frame Finishing & Codes / Finiture Telai e Codici

cod. 226.-- /A

€ 140,00

SPYKER CHAIRS TROLLEY CARRELLO PER SEDIE

Trolley for chairs model Spyker, black painted.
Carrello porta sedie modello Spyker, verniciato nero.

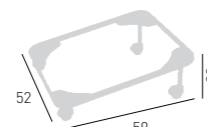

0,09 m³ - 5,5kg
61x54x25cm
1 pcs [carton]

Frame Finishing & Codes / Finiture Telai e Codici

cod.2002/A

€ 222,00

Sunlounger Doge



Available colors / Colori disponibili

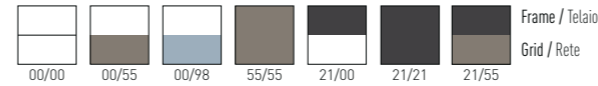

DOGE

Stackable sun lounger, with toughened, co-injected techno-polymer, steel and aluminum frame. High-resistance and flexible techno-polymer-injected slats, casters for ease of manoeuvrability, and back adjustable to five positions.

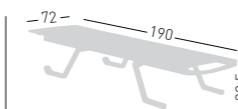

stackable / impilabile
A assembled / assemblato



0,80 m³ - 56 kg.
192x74x55cm.
4 pcs [carton]



3,2 m³ - 333 kg.
192x74x222cm.
24 pcs [pallet]



container 20° 212pcs
container 40° 424pcs

Frame Finishing & Codes / Finiture Telai e Codici

cod.200.-- /A

cod.200.-- /AI (pallet)

€ 580,00

€ 546,00

Minimum Order Quantity follows the packaging or multiply each code.
L'ordine minimo per ogni codice è pari all'imballo o multipli dello stesso.

Letto prendisole impilabile, con struttura ad alta resistenza in tecnopolimero, acciaio co-iniettato e traversi in alluminio. Maglia flessibile in tecnopolimero traspirante ad alta resistenza, rotelle per trasporto e schienale regolabile in 5 posizioni.

Sunlounger Podio



Available colors / Colori disponibili

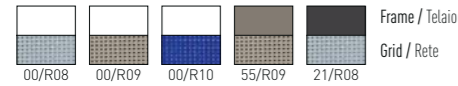

PODIO

Stackable sun lounger, with toughened, co-injected techno-polymer, steel and aluminum frame. High-resistance ventilated mesh, casters for ease of manoeuvrability, and back adjustable to five positions.



Letino prendisole impilabile, con struttura ad alta resistenza in tecnopolimero, acciaio co-iniettato e traversi in alluminio. Maglia in rete traspirante ad alta resistenza, rotelle per trasporto e schienale regolabile in 5 posizioni.

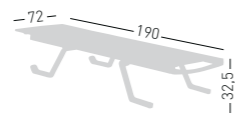

stackable / impilabile
A assembled / assemblato



0,80 m³ - 47 kg.
192x74x55cm.
4 pcs [carton]



3,2 m³ - 280 kg.
192x74x222cm.
24 pcs [pallet]



container 20' 212pcs
container 40' 424pcs

Frame Finishing & Codes / Finiture Telai e Codici

cod.201.__-R_/A
cod.201.__-R_/AI (pallet)

€ 654,00
€ 618,00

Minimum Order Quantity follows the packaging or multiply each code. L'ordine minimo per ogni codice è pari all'imballo o multipli dello stesso.

Teckel



Available colors for mesh back
Colori disponibili per schienale in rete

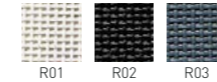

Products follows UNI 9175 -UNI 9175/FA, in terms of Fire Resistance, Fire Reation Class 1IM
Prodotto Omologato dal Ministero dell'Interno, secondo la UNI 9175 -UNI 9175/FA, con classe di Reazione al fuoco 1IM



Seat available fabric / Tessuti disponibili per sedile
King L fabric / Tessuto King L L (4pcs min.)
King fabric / Tessuto King K (4pcs min.)
Blazer fabric / Tessuto Blazer B (4pcs min.)
Kvadrat fabrics / Tessuti Kvadrat DK (4pcs min.)
COM fabric / Tessuto cliente TC (10pcs min.)

TECKEL

Black or white painted 4-legged frame, mesh back.
Telaio 4 gambe verniciato nero o bianco, schienale in rete.

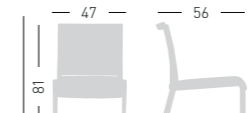

stackable / impilabile (4pcs)
NA not assembled / non assemblato



0,38 m³ - 22 kg.
59x65x99cm.
4 pcs [carton]

Frame Finishing & Codes / Finiture Telai e Codici

cod.800.__-_/ILNAN black painted/verniciato nero	€ 454,00
cod.800.__-_/ILNAB white painted/verniciato bianco	€ 454,00
cod.800.__-_/IKNAN black painted/verniciato nero	€ 454,00
cod.800.__-_/IKNAB white painted/verniciato bianco	€ 454,00
cod.800.__-_/IBNAN black painted/verniciato nero	€ 480,00
cod.800.__-_/IBNAB white painted/verniciato bianco	€ 480,00
cod.800.__-_/IDKNAN black painted/verniciato nero	€ 506,00
cod.800.__-_/IDKNAB white painted/verniciato bianco	€ 506,00
cod.800.__-_/ITCNAN black painted/verniciato nero	€ 426,00
cod.800.__-_/ITCNAB white painted/verniciato bianco	€ 426,00

Fabric required
Fabbisogno di tessuto
2 pcs: Lin Mtrs 1 (h1,40)

COM fabric min. order
10pcs each code
Tessuto cliente TC ordine
min. 10pz per codice

Min. order 4pcs
each code
Ordine min 4pz
per codice

TECKEL B

4-legged frame with armrests, mesh back.
Telaio 4 gambe con braccioli, schienale in rete.



stackable / impilabile (4pcs)
NA not assembled / non assemblato



0,38 m³ - 25 kg.
59x65x99cm.
4 pcs [carton]

Frame Finishing & Codes / Finiture Telai e Codici

cod.801.__-_/ILNAN black painted/verniciato nero	€ 532,00
cod.801.__-_/ILNAB white painted/verniciato bianco	€ 532,00
cod.801.__-_/IKNAN black painted/verniciato nero	€ 532,00
cod.801.__-_/IKNAB white painted/verniciato bianco	€ 532,00
cod.801.__-_/IBNAN black painted/verniciato nero	€ 558,00
cod.801.__-_/IBNAB white painted/verniciato bianco	€ 558,00
cod.801.__-_/IDKNAN black painted/verniciato nero	€ 586,00
cod.801.__-_/IDKNAB white painted/verniciato bianco	€ 586,00
cod.801.__-_/ITCNAN black painted/verniciato nero	€ 506,00
cod.801.__-_/ITCNAB white painted/verniciato bianco	€ 506,00

Fabric required
Fabbisogno di tessuto
2 pcs: Lin Mtrs 1 (h1,40)

COM fabric min. order
10pcs each code
Tessuto cliente TC ordine
min. 10pz per codice

Min. order 4pcs
each code
Ordine min 4pz
per codice

TECKEL R



4-legged frame with castors, mesh back.
Telaio 4 gambe con ruote, schienale in rete.

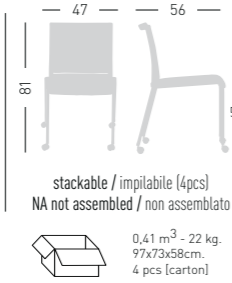

stackable / impilabile (4pcs)
NA not assembled / non assemblato
0,41 m³ - 22 kg.
97x73x58cm.
4 pcs (carton)

Frame Finishing & Codes / Finiture Telaie e Codici

cod.800.--/ILNANR black painted/verniciato nero	€ 480,00
cod.800.--/ILNABR white painted/verniciato bianco	€ 480,00
cod.800.--/IKNANR black painted/verniciato nero	€ 480,00
cod.800.--/IKNABR white painted/verniciato bianco	€ 480,00
cod.800.--/IBNANR black painted/verniciato nero	€ 506,00
cod.800.--/IBNABR white painted/verniciato bianco	€ 506,00
cod.800.--/IDKNANR black painted/verniciato nero	€ 532,00
cod.800.--/IDKNABR white painted/verniciato bianco	€ 532,00
cod.800.--/ITCNANR black painted/verniciato nero	€ 466,00
cod.800.--/ITCNABR white painted/verniciato bianco	€ 466,00

Fabric required
Fabbisogno di tessuto
2 pcs: Lin Mtrs 1 (h1,40)

COM fabric min. order
10pcs each code
Tessuto cliente TC ordine
min. 10pz per codice

Min. order 4pcs
each code
Ordine min 4pz
per codice

TECKEL B R



4-legged frame with castors and armrests, mesh back.
Telaio 4 gambe con ruote e braccioli, schienale in rete.

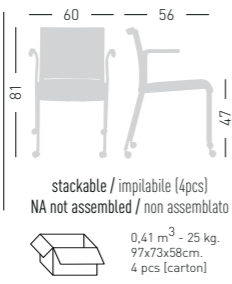

stackable / impilabile (4pcs)
NA not assembled / non assemblato
0,41 m³ - 25 kg.
97x73x58cm.
4 pcs (carton)

Frame Finishing & Codes / Finiture Telaie e Codici

cod.801.--/ILNANR black painted/verniciato nero	€ 558,00
cod.801.--/ILNABR white painted/verniciato bianco	€ 558,00
cod.801.--/IKNANR black painted/verniciato nero	€ 558,00
cod.801.--/IKNABR white painted/verniciato bianco	€ 558,00
cod.801.--/IBNANR black painted/verniciato nero	€ 586,00
cod.801.--/IBNABR white painted/verniciato bianco	€ 586,00
cod.801.--/IDKNANR black painted/verniciato nero	€ 612,00
cod.801.--/IDKNABR white painted/verniciato bianco	€ 612,00
cod.801.--/ITCNANR black painted/verniciato nero	€ 532,00
cod.801.--/ITCNABR white painted/verniciato bianco	€ 532,00

Fabric required
Fabbisogno di tessuto
2 pcs: Lin Mtrs 1 (h1,40)

COM fabric min. order
10pcs each code
Tessuto cliente TC ordine
min. 10pz per codice

Min. order 4pcs
each code
Ordine min 4pz
per codice

TECKEL CHAIRS TROLLEY CARRELLO PER SEDIE



Painted grey adjustable Dolly, for 4 legged chairs.
Carrello per sedie 4 gambe, regolabile, verniciato grigio.

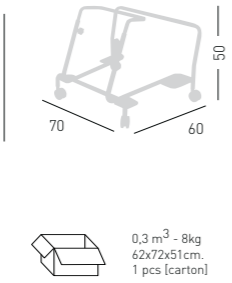

0,3 m³ - 8kg
62x72x51cm.
1 pcs (carton)

Frame Finishing & Codes / Finiture Telaie e Codici

cod.2001/A	€ 580,00
------------	----------

available for 4 Legged and 4 Legged with arms version
disponibile per versione 4 gambe e 4 gambe con braccioli

Together



Available colors / Colori disponibili

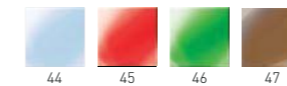

TOGETHER



Techno-polymer shell, oak frame.
Scocca in tecnopolimero, telaio in rovere.

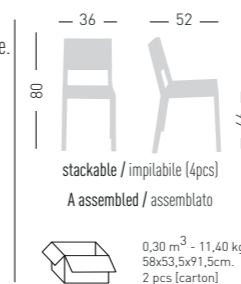

stackable / impilabile (4pcs)
A assembled / assemblato

0,30 m³ - 11,40 kg.
58x53,5x91,5cm.
2 pcs (carton)

Frame Finishing & Codes / Finiture Telaie e Codici

cod. 138.--/A oak/rovere

€ 630,00



Available colors / Colori disponibili

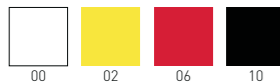

IGN Versions follows UNI 9177 certification in terms of Fire Resistance, Fire Reaction Class 2
Versioni IGN prodotto Omologato con Classe di Reazione al fuoco 2, UNI 9177



TULIP



Techno-polymer shell with anodized aluminum legs.
Scocca in tecnopolimero e gambe in alluminio anodizzato.



stackable / impilabile (6pcs)
A assembled / assemblato

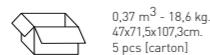

Frame Finishing & Codes / Finiture Telai e Codici

cod.48.--/A assembled/assemblata € **104,00**

cod.48.--/IGN fire retardant/ignifuga fire retardant minimum 300 pcs ignifuga minimo 300 pz € **162,00**

cod.53.--- dark legs/gamba antracite minimum 200 pcs/minimo 200 pz € **134,00**

TULIP B



Techno-polymer shell with integrated armrests, anodized aluminum legs.
Scocca in tecnopolimero con braccioli integrati, gambe in alluminio anodizzato.

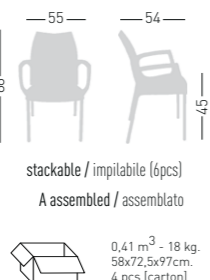

stackable / impilabile (6pcs)
A assembled / assemblato



Frame Finishing & Codes / Finiture Telai e Codici

cod.51.--/A assembled/assemblata € **112,00**

cod.51.--/IGN fire retardant/ignifuga fire retardant minimum 300 pcs ignifuga minimo 300 pz € **170,00**

cod.52.--- dark legs/gamba antracite minimum 200 pcs/minimo 200 pz € **138,00**

TULIP CHAIRS TROLLEY CARRELLO PER SEDIE



Trolley for chairs model Tulip, black painted.
Carrello porta sedie modello Tulip, verniciato nero.

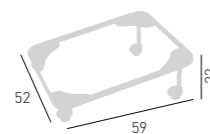

Frame Finishing & Codes / Finiture Telai e Codici

cod.2002/A € **222,00**



VENEZIA UPHOLSTERED



Techno-polymer upholstered chair in eco-leather.
Sedia in tecnopolimero imbottita in ecopelle.

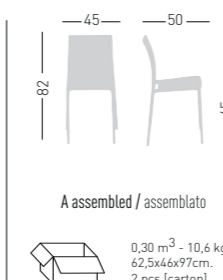

A assembled / assemblato



Frame Finishing & Codes / Finiture Telai e Codici

cod.30.--/IEA € **342,00**
cod.30/ITCA € **282,00**

Fabric required
Fabbisogno di tessuto
1 pcs: Lin Mtrs 1 (h1,40)

COM fabric min. order
10pcs each code
Tessuto cliente TC ordine
min. 10pz per codice

Min. order 4pcs
each code
Ordine min 4pz
per codice

Available coverings / Finiture disponibili
Aurea eco-leather / Ecopelle aurea **E** (4pcs min.)
COM fabric / Tessuto cliente **TC** (10pcs min.)

STOOLS Collection

Abuela Stool



Available colors / Colori disponibili

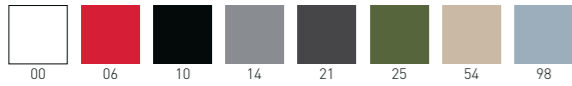

ABUELA STOOL 77 Stackable techno-polymer stool.
Sgabello impilabile in tecnopolimero.



Frame Finishing & Codes / Finiture Telai e Codici
cod.294._/77A

€ **194,00**

ABUELA STOOL 67 Stackable techno-polymer stool.
Sgabello impilabile in tecnopolimero.



Frame Finishing & Codes / Finiture Telai e Codici
cod.294._/67A

€ **194,00**

ABUELA UPHOLSTERED IMBOTTITI

Available fabric / Tessuti disponibili
King fabric / Tessuto King **K** (20pcs min.)
Kvadrat fabrics / Tessuti Kvadrat - Remix 3 **DK** (20pcs min.)

Steelcut 2 Fabric not available on this product
Tessuto Steelcut 2 non disponibile per questo prodotto

ABUELA LARGE STOOL

Upholstered stool, wooden beech frame.
Sgabello imbottito, telaio in legno di faggio.

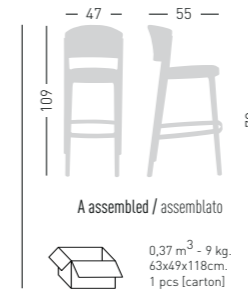

Frame Finishing & Codes / Finiture Telai e Codici

cod.298._/IK78BLF
cod.298._/IDK78BLF

€ **1.604,00**
€ **1.724,00**

Minimum order 20 pcs each code
Ordine minimo 20 pezzi per codice

Akami



Available colors / Colori disponibili

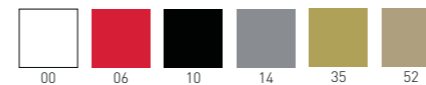

AKAMI ST 75

Techno-polymer seat and chromed or outdoor painted stackable frame.
Sgabello con seduta in tecnopolimero e telaio impilabile in metallo cromato o verniciato per esterno.



only for painted frames
solo per telai verniciati

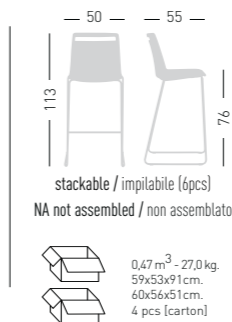

Frame Finishing & Codes / Finiture Telai e Codici

cod. 196.-- /76ST chromed/cromata
cod. 196.-- /76STB white painted/verniciato bianco
cod. 196.-- /76STN black painted/verniciato nero

€ **268,00**
€ **320,00**
€ **320,00**

AKAMI ST 65

Techno-polymer seat and chromed or outdoor painted stackable frame.
Sgabello con seduta in tecnopolimero e telaio impilabile in metallo cromato o verniciato per esterno.



only for paintend frames
solo per telai verniciati

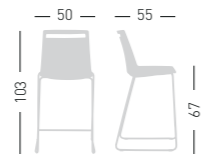

stackable / impilabile (6pcs)
NA not assembled / non assemblato



0,47 m³ - 25,5 kg.
59x53x91cm.
60x56x51cm.
4 pcs [carton]

Frame Finishing & Codes / Finiture Telai e Codici

cod. 196.--/66ST chromed/cromata
cod. 196.--/66STB white painted/verniciato bianco
cod. 196.--/66STN black painted/verniciato nero

€ 268,00
€ 320,00
€ 320,00

AKAMI CUSHION / CUSCINO

Upholstered cushion.
Cuscino tappezzato.



Available fabric.
Tessuti disponibili.
B, E, K, DK
COM fabric / Tessuto cliente **TC**



0,5 kg.
Inside stools
boxes
Nella scatola
degli sgabelli.

Frame Finishing & Codes / Finiture Telai e Codici

cod.305.-- (B)
cod.305.-- (E)
cod.305.-- (K)
cod.305.-- (DK)
cod.305.TC COM fabric/tessuto cliente

€ 124,00
€ 106,00
€ 106,00
€ 130,00
€ 92,00

Fabric required
Fabbisogno di tessuto
4 pcs : Lin Mtrs 1 (h1,40)

COM fabric min. order
10pcs each code
Tessuto cliente TC ordine
min. 10pz per codice

Min. order 4pcs
each code
Ordine min 4pz
per codice

AKAMI UPHOLSTERED IMBOTTITI

Available coverings / Finiture disponibili
King fabric / Tessuto King **K** (4pcs min.)
Blazer fabric / Tessuto Blazer **B** (4pcs min.)
Kvadrat fabrics / Tessuti Kvadrat **DK** (4pcs min.)
COM fabric / Tessuto cliente **TC** (10pcs min.)

AKAMI ST 75 UPHOLSTERED

PU-Flex padded and upholstered shell, chromed or painted frame.
Sgabello con scocca imbottita in PU-Flex e rivestita, telaio in metallo cromato o verniciato.



NA not assembled / non assemblato

0,53 m³ - 32,5 kg.
59x53x91cm
66x55x63cm
4 pcs [carton]

Frame Finishing & Codes / Finiture Telai e Codici

cod.196.--/IK76ST chromed/cromata
cod.196.--/IK76STB white/bianco
cod.196.--/IK76STN black/nero
cod.196.--/IB76ST chromed/cromata
cod.196.--/IB76STB white/bianco
cod.196.--/IB76STN black/nero
cod.196.--/DK76ST chromed/cromata
cod.196.--/DK76STB white/bianco
cod.196.--/DK76STN black/nero
cod.196./ITC76ST chromed/cromata
cod.196./ITC76STB white/bianco
cod.196./ITC76STN black/nero

€ 510,00
€ 566,00
€ 566,00
€ 536,00
€ 592,00
€ 592,00
€ 660,00
€ 718,00
€ 718,00
€ 456,00
€ 510,00
€ 510,00

Fabric required
Fabbisogno di tessuto
1 pcs: Lin Mtrs 1 (h1,40)

COM fabric min. order
10pcs each code
Tessuto cliente TC ordine
min. 10pz per codice

Min. order 4pcs
each code
Ordine min 4pz
per codice

AKAMI ST 65 UPHOLSTERED

PU-Flex padded and upholstered shell, chromed or painted frame.
Sgabello con scocca imbottita in PU-Flex e rivestita, telaio in metallo cromato o verniciato.

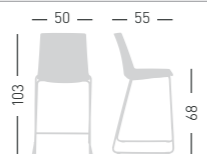

NA not assembled / non assemblato

0,53 m³ - 31,0 kg.
59x53x91cm
66x55x63cm
4 pcs [carton]

Frame Finishing & Codes / Finiture Telai e Codici

cod.196.--/IK66ST chromed/cromata
cod.196.--/IK66STB white/bianco
cod.196.--/IK66STN black/nero
cod.196.--/IB66ST chromed/cromata
cod.196.--/IB66STB white/bianco
cod.196.--/IB66STN black/nero
cod.196.--/DK66ST chromed/cromata
cod.196.--/DK66STB white/bianco
cod.196.--/DK66STN black/nero
cod.196./ITC66ST chromed/cromata
cod.196./ITC66STB white/bianco
cod.196./ITC66STN black/nero

€ 510,00
€ 566,00
€ 566,00
€ 536,00
€ 592,00
€ 592,00
€ 660,00
€ 718,00
€ 718,00
€ 456,00
€ 510,00
€ 510,00

Fabric required
Fabbisogno di tessuto
1 pcs: Lin Mtrs 1 (h1,40)

COM fabric min. order
10pcs each code
Tessuto cliente TC ordine
min. 10pz per codice

Min. order 4pcs
each code
Ordine min 4pz
per codice



Available colors / Colori disponibili

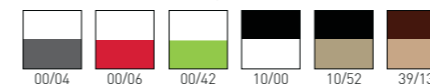

Shell / Scocca
Exagon design / Disegno esagonale

ALHAMBRA 77

Techno-polymer seat, chromed or outdoor painted frame.
Seduta in tecnopolimero, telaio cromato o verniciato per esterno.



only for paintend frames
solo per telai verniciati

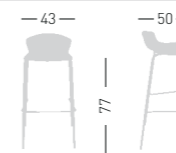

NA not assembled / non assemblato



0,24 m³ - 21,6 kg.
91x59x43cm.
4 pcs [carton]

Frame Finishing & Codes / Finiture Telai e Codici

cod. 98.-- / 77 NA chromed/cromata
cod. 98.-- / 77 NAN black painted/verniciato nero
cod. 98.-- / 77 NAB white painted/verniciato bianco

€ 194,00
€ 218,00
€ 218,00

ALHAMBRA 67

Techno-polymer seat, chromed or outdoor painted frame.
Seduta in tecnopolimero, telaio cromato o verniciato per esterno.



only for paintend frames
solo per telai verniciati



NA not assembled / non assemblato



0,24m³ - 20,4 kg.
91x59x43cm.
4 pcs [carton]

Frame Finishing & Codes / Finiture Telai e Codici

cod. 98.-- / 67 NA chromed/cromata
cod. 98.-- / 67 NAN black painted/verniciato nero
cod. 98.-- / 67 NAB white painted/verniciato bianco

€ 194,00
€ 218,00
€ 218,00

ALHAMBRA 97A

Techno-polymer seat, chromed frame combined base.
Seduta in tecnopolimero, telaio cromato e base abbinata.

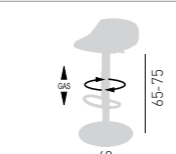

A assembled / assemblato



0,19 m³ - 12 kg.
46x46x89cm.
1 pcs [carton]

Frame Finishing & Codes / Finiture Telai e Codici

cod. 97.-- / A

€ 352,00

The base is in the same colour of the seat's back
La base ha lo stesso colore del fondo della seduta

ALHAMBRA 97AV

Techno-polymer seat, chromed frame and chromed base.
Seduta in tecnopolimero, telaio cromato e base cromata.

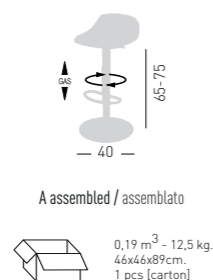

Frame Finishing & Codes / Finiture Telai e Codici

cod. 97.-- /AV chromed base/base cromata

€ 402,00

0,19 m³ - 12,5 kg.
46x46x89cm.
1 pcs [carton]

ALHAMBRA ST 76

Techno-polymer seat and chromed or outdoor painted stackable frame.
Sgabello con seduta in tecnopolimero e telaio impilabile in metallo cromato o verniciato per esterno.



only for paintend frames
solo per telai verniciati

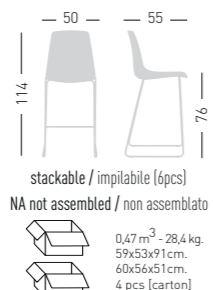

Frame Finishing & Codes / Finiture Telai e Codici

cod.192.--/76ST chromed/cromata

cod.192.--/76STB white painted/verniciato bianco

cod.192.--/76STN black painted/verniciato nero

€ 256,00

€ 306,00

€ 306,00

0,47 m³ - 28,4 kg.
59x53x91cm.
60x56x51cm.
4 pcs [carton]

ALHAMBRA ST 66

Techno-polymer seat and chromed or outdoor painted stackable frame.
Sgabello con seduta in tecnopolimero e telaio impilabile in metallo cromato o verniciato per esterno.



only for paintend frames
solo per telai verniciati

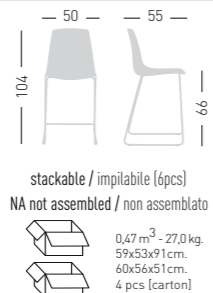

Frame Finishing & Codes / Finiture Telai e Codici

cod.192.--/66ST chromed/cromata

cod.192.--/66STB white painted/verniciato bianco

cod.192.--/66STN black painted/verniciato nero

€ 256,00

€ 306,00

€ 306,00

0,47 m³ - 27,0 kg.
59x53x91cm.
60x56x51cm.
4 pcs [carton]

ALHAMBRA UPHOLSTERED IMBOTTITI

Available coverings / Finiture disponibili
Aurea eco-leather / Ecopelle aurea **E** (4pcs min.)
King fabric / Tessuto King **K** (4pcs min.)
Blazer fabric / Tessuto Blazer **B** (4pcs min.)
COM fabric / Tessuto cliente **TC** (10pcs min.)

DRESS ALHAMBRA 77

Upholstered techno-polymer shell, chromed or paintend frame.
Scocca in tecnopolimero rivestito, telaio cromato o verniciato

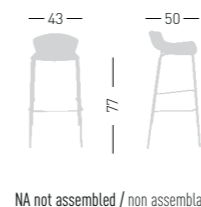

NA not assembled / non assemblato

0,24 m³ - 13,5 kg.
91x59x43cm.
2 pcs [carton]

Frame Finishing & Codes / Finiture Telai e Codici

cod.98.--/IE77NA chromed/cromato

cod.98.--/IE77NAB white/bianco

cod.98.--/IE77NAN black/nero

€ 426,00

€ 460,00

€ 460,00

cod.98.--/IK77NA chromed/cromato

cod.98.--/IK77NAB white/bianco

cod.98.--/IK77NAN black/nero

€ 426,00

€ 460,00

€ 460,00

cod.98.--/IB77NA chromed/cromato

cod.98.--/IB77NAB white/bianco

cod.98.--/IB77NAN black/nero

€ 448,00

€ 482,00

€ 482,00

cod.98/ITC77NA chromed/cromato

cod.98/ITC77NAB white/bianco

cod.98/ITC77NAN black/nero

€ 396,00

€ 434,00

€ 434,00

Fabric required
Fabbisogno di tessuto
1 pcs: Lin Mtrs 0,5 (h1,40)

COM fabric min. order
10pcs each code
Tessuto cliente TC ordine
min. 10pz per codice

Min. order 4pcs
each code
Ordine min 4pz
per codice

DRESS ALHAMBRA 67

Upholstered techno-polymer shell, chromed or paintend frame.
Scocca in tecnopolimero rivestito, telaio cromato o verniciato

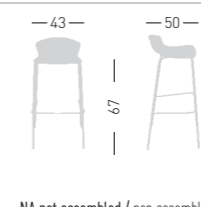

NA not assembled / non assemblato

0,24 m³ - 13 kg.
91x59x43cm.
2 pcs [carton]

Frame Finishing & Codes / Finiture Telai e Codici

cod.98.--/IE67NA chromed/cromato

cod.98.--/IE67NAB white/bianco

cod.98.--/IE67NAN black/nero

€ 426,00

€ 460,00

€ 460,00

cod.98.--/IK67NA chromed/cromato

cod.98.--/IK67NAB white/bianco

cod.98.--/IK67NAN black/nero

€ 426,00

€ 460,00

€ 460,00

cod.98.--/IB67NA chromed/cromato

cod.98.--/IB67NAB white/bianco

cod.98.--/IB67NAN black/nero

€ 448,00

€ 482,00

€ 482,00

cod.98/ITC67NA chromed/cromato

cod.98/ITC67NAB white/bianco

cod.98/ITC67NAN black/nero

€ 396,00

€ 434,00

€ 434,00

Fabric required
Fabbisogno di tessuto
1 pcs: Lin Mtrs 0,5 (h1,40)

COM fabric min. order
10pcs each code
Tessuto cliente TC ordine
min. 10pz per codice

Min. order 4pcs
each code
Ordine min 4pz
per codice

DRESS ALHAMBRA 97 A



Upholstered techno-polymer seat and chromed frame.
Sgabello con seduta in tecnopolimero rivestito e telaio in metallo cromato

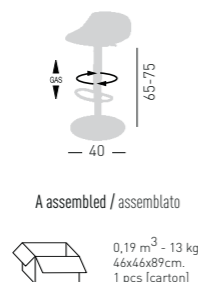

A assembled / assemblato

0,19 m³ - 13 kg.
46x46x89cm.
1 pcs (carton)

Frame Finishing & Codes / Finiture Telai e Codici

cod.97.--/IEA
cod.97.--/IKA
cod.97./ITCA
cod.97.--/IBA

€ 616,00
€ 594,00
€ 594,00
€ 564,00

Fabric required
Fabbisogno di tessuto
1 pcs: Lin Mtrs 0,5 (h1,40)

COM fabric min. order
10pcs each code
Tessuto cliente TC ordine
min. 10pz per codice

Min. order 4pcs
each code
Ordine min 4pz
per codice

DRESS ALHAMBRA 97 AV



Upholstered techno-polymer seat and chromed frame.
Sgabello con seduta in tecnopolimero rivestito e telaio in metallo cromato

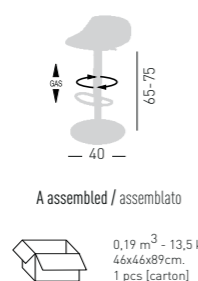

A assembled / assemblato

0,19 m³ - 13,5 kg.
46x46x89cm.
1 pcs (carton)

Frame Finishing & Codes / Finiture Telai e Codici

cod.97.--/IEAV
cod.97.--/IKAV
cod.97./ITCAV
cod.97.--/IBAV

€ 672,00
€ 650,00
€ 650,00
€ 620,00

Fabric required
Fabbisogno di tessuto
1 pcs: Lin Mtrs 0,5 (h1,40)

COM fabric min. order
10pcs each code
Tessuto cliente TC ordine
min. 10pz per codice

Min. order 4pcs
each code
Ordine min 4pz
per codice

DRESS ALHAMBRA ST 76



Upholstered techno-polymer seat, chromed or painted frame.
Sgabello con seduta in tecnopolimero rivestito e telaio in metallo cromato o verniciato.

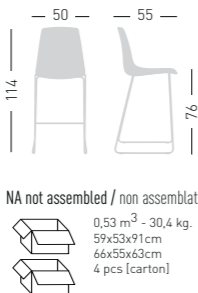

NA not assembled / non assemblato

0,53 m³ - 30,4 kg.
59x53x91cm
66x55x63cm
4 pcs (carton)

Frame Finishing & Codes / Finiture Telai e Codici

cod.192.--/IE76ST chromed/cromata
cod.192.--/IE76STB white/bianco
cod.192.--/IE76STN black/nero
cod.192.--/IK76ST chromed/cromata
cod.192.--/IK76STB white/bianco
cod.192.--/IK76STN black/nero
cod.192.--/IB76ST chromed/cromata
cod.192.--/IB76STB white/bianco
cod.192.--/IB76STN black/nero
cod.192./ITC76ST chromed/cromata
cod.192./ITC76STB white/bianco
cod.192./ITC76STN black/nero

€ 454,00
€ 508,00
€ 508,00
€ 454,00
€ 508,00
€ 508,00
€ 480,00
€ 534,00
€ 534,00
€ 426,00
€ 482,00
€ 482,00

Fabric required
Fabbisogno di tessuto
1 pcs: Lin Mtrs 1 (h1,40)

COM fabric min. order
10pcs each code
Tessuto cliente TC ordine
min. 10pz per codice

Min. order 4pcs
each code
Ordine min 4pz
per codice

DRESS ALHAMBRA ST 66



Upholstered techno-polymer seat, chromed or painted frame.
Sgabello con seduta in tecnopolimero rivestito e telaio in metallo cromato o verniciato.

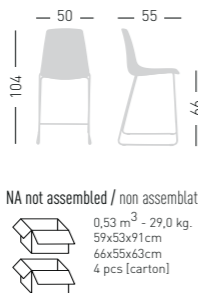

NA not assembled / non assemblato

0,53 m³ - 29,0 kg.
59x53x91cm
66x55x63cm
4 pcs (carton)

Frame Finishing & Codes / Finiture Telai e Codici

cod.192.--/IE66ST chromed/cromata
cod.192.--/IE66STB white/bianco
cod.192.--/IE66STN black/nero
cod.192.--/IK66ST chromed/cromata
cod.192.--/IK66STB white/bianco
cod.192.--/IK66STN black/nero
cod.192.--/IB66ST chromed/cromata
cod.192.--/IB66STB white/bianco
cod.192.--/IB66STN black/nero
cod.192./ITC66ST chromed/cromata
cod.192./ITC66STB white/bianco
cod.192./ITC66STN black/nero

€ 454,00
€ 508,00
€ 508,00
€ 454,00
€ 508,00
€ 508,00
€ 480,00
€ 534,00
€ 534,00
€ 426,00
€ 482,00
€ 482,00

Fabric required
Fabbisogno di tessuto
1 pcs: Lin Mtrs 1 (h1,40)

COM fabric min. order
10pcs each code
Tessuto cliente TC ordine
min. 10pz per codice

Min. order 4pcs
each code
Ordine min 4pz
per codice



Available colors / Colori disponibili

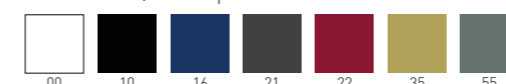

AMITHA STOOL



4-Legged metal stool, painted with special treatment for outdoor purpose.
Sgabello con struttura 4 gambe in metallo verniciato con trattamento per esterno.

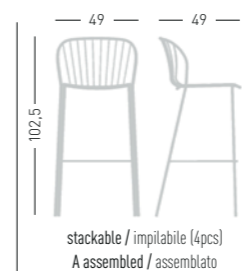

stackable / impilabile (4pcs)
A assembled / assemblato

0,43 m³ - 22 kg.
60x59x118cm.
2 pcs (carton)

Frame Finishing & Codes / Finiture Telai e Codici

cod. 80._/A

€ 322,00

Min. order 4pcs
each code
Ordine min 4pz
per codice

AMITHA STOOL CUSHION / CUSCINO



Cushion with removable cover, suitable for outdoor purpose; high density bielastic rubber padding, stitching made with raised edge. The cushion is fixed to the stool by Velcro straps.
Cuscino sfoderabile, adatto ad uso per esterni; imbottiture in gomma bielastic ad alta densità, cucitura realizzata con bordino in rilievo riportato. Il cuscino si fissa allo sgabello per mezzo di fascette in Velcro.



0,6 kg
Inside chairs boxes
Inseriti nella scatola delle sedie

Frame Finishing & Codes / Finiture Telai e Codici

cod. 339.-- (MG)
cod. 339.-- (SX)

€ 136,00
€ 136,00

Min. order 4pcs
each code
Ordine min 4pz
per codice

Available fabric.
Tessuti disponibili.
MG, SX

Artesia Stool



ARTESIA STOOL NARROW CUSHION / CUSCINO STRETTO



Narrow upholstered cushion, suitable for stool stackability. Cuscino tappezzato stretto, adatto a sgabelli che devono essere impilati.

Available fabric. Tessuti disponibili.
B, E, K, DK
COM fabric / Tessuto cliente **TC** (10 pcs min)



0,450kg/pz
Inside chairs boxes
Inseriti nella
scatola delle sedie

Frame Finishing & Codes / Finiture Telai e Codici

cod.330.-- (B)	€	124,00
cod.330.-- (E)	€	106,00
cod.330.-- (K)	€	106,00
cod.330.-- (DK)	€	130,00
cod.330.TC COM fabric/tessuto cliente	€	92,00

Fabric required
Fabbisogno di tessuto
4 pcs: Lin Mtrs 1,0 (h1,40)

COM fabric min. order
10pcs each code
Tessuto cliente TC ordine
min. 10pz per codice

Min. order 4pcs
each code
Ordine min 4pz
per codice

ARTESIA STOOL WIDE CUSHION / CUSCINO LARGO



Large upholstered cushion. Cuscino tappezzato largo.

Available fabric. Tessuti disponibili.
B, E, K, DK
COM fabric / Tessuto cliente **TC**
(10 pcs min)



0,500kg/pz
Inside chairs boxes
Inseriti nella
scatola delle sedie

Frame Finishing & Codes / Finiture Telai e Codici

cod.331.-- (B)	€	130,00
cod.331.-- (E)	€	112,00
cod.331.-- (K)	€	112,00
cod.331.-- (DK)	€	136,00
cod.331.TC COM fabric/tessuto cliente	€	96,00

Fabric required
Fabbisogno di tessuto
4 pcs: Lin Mtrs 1,2 (h1,40)

COM fabric min. order
10pcs each code
Tessuto cliente TC ordine
min. 10pz per codice

Min. order 4pcs
each code
Ordine min 4pz
per codice

IGN Versions follows UNI 9177 certification in terms of Fire Resistance, Fire Reaction Class 1
Versioni IGN prodotto Omologato con Classe di Reazione al fuoco 1. UNI 9177



Available Shell Color / Colori disponibili Scocca

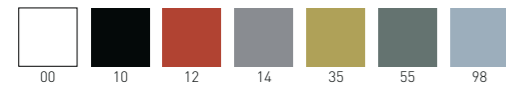

Frame Finishes / Finiture telaio

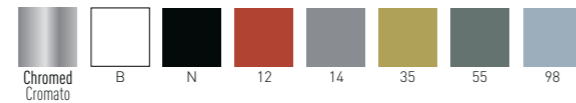

ARTESIA STOOL 75 Stool made with a techno-polymer seat and a wire steel stackable frame. Sgabellito con seduta in tecnopolimero e telaio impilabile in tondino metallico.

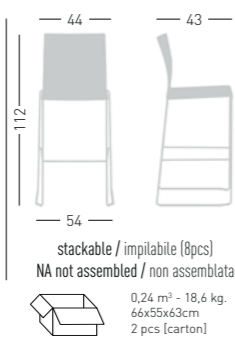

stackable / impilabile (8pcs)
NA not assembled / non assemblata
0,24 m³ - 18,6 kg.
66x55x63cm
2 pcs [carton]

Frame Finishing & Codes / Finiture Telai e Codici

cod. 112.__/755 chromed/cromata	€	250,00
cod. 112.__/755B white painted/verniciato bianco	€	250,00
cod. 112.__/755N black painted/verniciato nero	€	250,00
cod. 112.__/75555 mineral grey painted/verniciato grigio minerale	€	280,00
cod. 112.__/75514 pearl grey painted/verniciato grigio perla	€	280,00
cod. 112.__/75512 brick painted/verniciato mattone	€	280,00
cod. 112.__/75535 lime painted/verniciato lime	€	280,00
cod. 112.__/75598 pale blue painted/verniciato avio	€	280,00
cod. 112.00/IGN755-- Fire Retardant/Ignifuga Classe 1	€	308,00
cod. 112.55/IGN755-- Fire Retardant/Ignifuga Classe 1	€	308,00
cod. 112.14/IGN755-- Fire Retardant/Ignifuga Classe 1	€	308,00
cod. 112.98/IGN755-- Fire Retardant/Ignifuga Classe 1	€	308,00

Minimum order 4pcs each code
Ordine minimo 4 pezzi per codice

Fire Retardant minimum Order 20pcs
Ignifuga ordine Minimo 20pz

Black glides on black frames.
Neutral glides on other frame finishes.
Piedini neri su telai neri.
Piedini neutri nelle altre finiture telai.



Asole

Available coverings / Finiture disponibili
Leather / Cuoio C (4pcs min.)

ASOLO
UPHOLSTERED



Techno-polymer seat upholstered in leather, chromed frame and base. Seduta in tecnopolimero rivestito cuoio, telaio e base cromati.

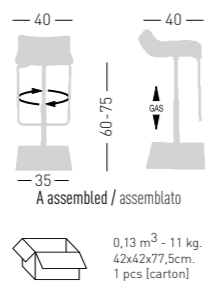

Frame Finishing & Codes / Finiture Telai e Codici

cod.59.--/ICA

€ 540,00

Min. order 4pcs each code
Ordine min 4pz per codice



Bakhita

Available colors / Colori disponibili

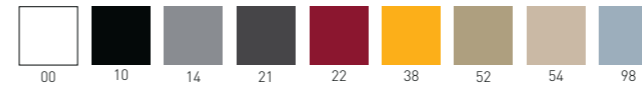

IGN Versions follows UNI 9177 certification in terms of Fire Resistance, Fire Reaction Class 1
Versioni IGN prodotto Omologato con Classe di Reazione al fuoco 1, UNI 9177



BAKHITA 76



Co-injected metal-polymer stackable stool. Sgabello impilabile in co-iniezione polimero-metallo.

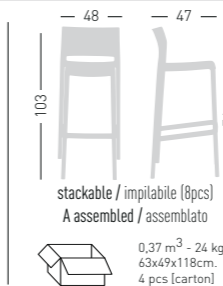

Frame Finishing & Codes / Finiture Telai e Codici

cod.372.--/76A

€ 210,00

cod.372.--/76IGN fire retardant/ignifugo

€ 282,00

Minimum order 300pcs/ Ordine minimo 300pcs

BAKHITA 66



Co-injected metal-polymer stackable stool. Sgabello impilabile in co-iniezione polimero-metallo.

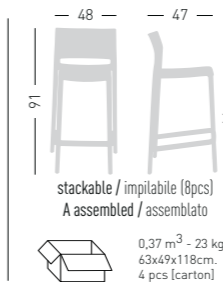

Frame Finishing & Codes / Finiture Telai e Codici

cod.372.--/66A

€ 210,00

cod.372.--/66IGN fire retardant/ignifugo

€ 282,00

Minimum order 300pcs/ Ordine minimo 300pcs

BAKHITA CUSHION / CUSCINO



Upholstered cushion. Cuscino tappezzato.

Available fabric. Tessuti disponibili. B, E, K, DK, TC



0,4 kg
Inside stools boxes
Nella scatola degli sgabelli

Frame Finishing & Codes / Finiture Telai e Codici

cod. 314.-- (B)

€ 122,00

cod. 314.-- (E)

€ 106,00

cod. 314.-- (K)

€ 106,00

cod. 314.--(DK)

€ 130,00

cod.314.TC COM fabric/tessuto cliente

€ 92,00

Fabric required
Fabbisogno di tessuto
4 pcs : Lin Mtrs 1 (h1,40)

COM fabric min. order
10pcs each code
Tessuto cliente TC ordine
min. 10pz per codice

Min. order 4pcs
each code
Ordine min 4pz
per codice



Available colors / Colori disponibili

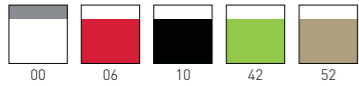

BLOG 78

Techno-polymer seat, chromed or outdoor painted frame. Seduta in tecnopolimero, telaio cromato o verniciato per esterno.



only for paintend frames solo per telai verniciati

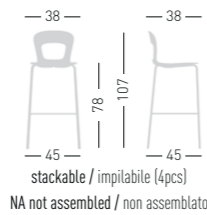

stackable / impilabile (4pcs)
NA not assembled / non assemblato



Frame Finishing & Codes / Finiture Telai e Codici

- cod. 145.-- / 78 NA chromed/cromata
- cod. 145.-- / 78 NAB white painted/verniciato bianco
- cod. 145.-- / 78 NAN black painted/verniciato nero

€ 268,00
€ 294,00
€ 294,00

BLOG 68

Techno-polymer seat, chromed or outdoor painted frame. Seduta in tecnopolimero, telaio cromato o verniciato per esterno.



only for paintend frames solo per telai verniciati

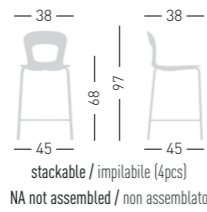

stackable / impilabile (4pcs)
NA not assembled / non assemblato



Frame Finishing & Codes / Finiture Telai e Codici

- cod. 145.-- / 68 NA chromed/cromata
- cod. 145.-- / 68 NAB white painted/verniciato bianco
- cod. 145.-- / 68 NAN black painted/verniciato nero

€ 268,00
€ 294,00
€ 294,00

BLOG 145A

Techno-polymer seat, chromed frame and combined base. Seduta in tecnopolimero, telaio cromato e base abbinata.

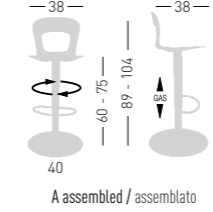

A assembled / assemblato



Frame Finishing & Codes / Finiture Telai e Codici

cod. 145.-- / A

€ 478,00

Base color combined with the seat
Colore base abbinato alla seduta

BLOG 145AV

Techno-polymer seat, chromed frame and chromed base. Seduta in tecnopolimero, telaio cromato e base cromata.

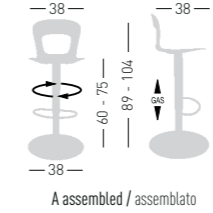

A assembled / assemblato



Frame Finishing & Codes / Finiture Telai e Codici

cod.145.--/AV chromed base/base cromata

€ 536,00

BLOG UPHOLSTERED IMBOTTITI

Available coverings / Finiture disponibili
Leather / Pelle **P** (4pcs min.)
King fabric / Tessuto King **K** (4pcs min.)

BLOG 78 UPHOLSTERED

Upholstered fabric or leather seat and chromed or painted metal frame. Seduta in tessuto o pelle, telaio in metallo cromato o verniciato.

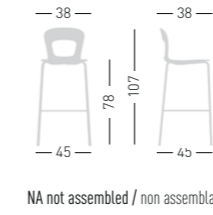

NA not assembled / non assemblato



Frame Finishing & Codes / Finiture Telai e Codici

- cod.145.--/IP78NA chromed/cromata
- cod.145.--/IP78NAB white/bianco
- cod.145.--/IP78NAN black/nero
- cod.145.--/IK78NA chromed/cromata
- cod.145.--/IK78NAB white/bianco
- cod.145.--/IK78NAN black/nero

€ 700,00
€ 726,00
€ 726,00
€ 588,00
€ 614,00
€ 614,00

Min. order 4pcs each code
Ordine min 4pz per codice

BLOG 68 UPHOLSTERED

Upholstered fabric or leather seat and chromed or painted metal frame. Seduta in tessuto o pelle, telaio in metallo cromato o verniciato.

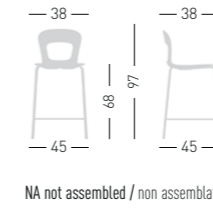

NA not assembled / non assemblato



Frame Finishing & Codes / Finiture Telai e Codici

- cod.145.--/IP68NA chromed/cromata
- cod.145.--/IP68NAB white/bianco
- cod.145.--/IP68NAN black/nero
- cod.145.--/IK68NA chromed/cromata
- cod.145.--/IK68NAB white/bianco
- cod.145.--/IK68NAN black/nero

€ 700,00
€ 726,00
€ 726,00
€ 588,00
€ 614,00
€ 614,00

Min. order 4pcs each code
Ordine min 4pz per codice

BLOG 145A
UPHOLSTERED



Upholstered fabric or leather seat, chromed metal frame and combined base.
Seduta in tessuto o pelle. Telaio metallo cromato e base abbinata.

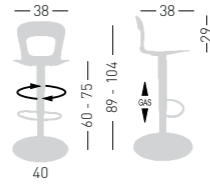

A assembled / assemblato



0,19 m³ - 12 kg.
46x46x89cm.
1 pcs [carton]

Frame Finishing & Codes / Finiture Telai e Codici

cod.145.--/IPA
cod.145.--/IKA

€ **840,00**
€ **726,00**

Min. order 4pcs
each code
Ordine min 4pz
per codice

BLOG 145A
UPHOLSTERED



Fabric or leather seat, chromed metal frame and base.
Seduta in tessuto o pelle.
Telaio e base in metallo cromato.

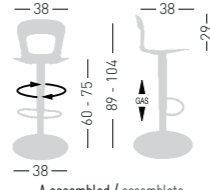

A assembled / assemblato



0,19 m³ - 12,5 kg.
46x46x89cm.
1 pcs [carton]

Frame Finishing & Codes / Finiture Telai e Codici

cod.145.--/IPAV chromed base/base cromata
cod.145.--/IKAV chromed base/base cromata

€ **896,00**
€ **782,00**

Min. order 4pcs
each code
Ordine min 4pz
per codice

Citro



Available colors / Colori disponibili

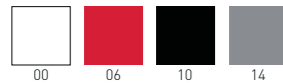

CITRO



Techno-polymer seat, chromed frame and combined base.
Seduta in tecnopolimero, telaio cromato e base abbinata.

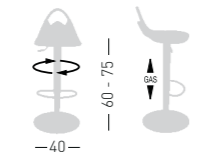

A assembled / assemblato



0,19 m³ - 11 kg.
46x46x89cm.
1 pcs [carton]

Frame Finishing & Codes / Finiture Telai e Codici

cod. 33.--/A

Base color combined with the seat
Colore base abbinato alla seduta

€ **314,00**

CITRO AV



Techno-polymer seat, chromed frame and chromed base.
Seduta in tecnopolimero, telaio cromato e base cromata.

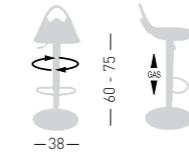

A assembled / assemblato



0,19 m³ - 11,5 kg.
46x46x89cm.
1 pcs [carton]

Frame Finishing & Codes / Finiture Telai e Codici

cod.33.--/AV chromed base/base cromata

€ **368,00**

Colorfive



Available colors / Colori disponibili

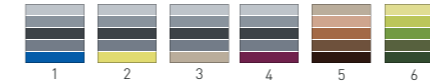

COLORFIVE ST 76



Techno-polymer seat and chromed or outdoor painted stackable frame.
Sgabellone con seduta in tecnopolimero e telaio impilabile in metallo cromato o verniciato per esterno.



stackable / impilabile (6pcs)
NA not assembled / non assemblato



0,47 m³ - 28,4 kg.
59x53x91cm.
60x56x51cm.
4 pcs [carton]

Frame Finishing & Codes / Finiture Telai e Codici

cod.235.--/76ST chromed/cromata
cod.235.--/76STB white/bianco
cod.235.--/76STN black/nero

€ **430,00**
€ **480,00**
€ **480,00**

only for painted frames
solo per telai verniciati

COLORFIVE ST 66



Techno-polymer seat and chromed or outdoor painted stackable frame.
Sgabello con seduta in tecnopolimero e telaio impilabile in metallo cromato o verniciato per esterno.



only for painted frames
solo per telai verniciati

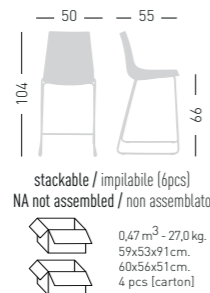

stackable / impilabile (6pcs)
NA not assembled / non assemblato

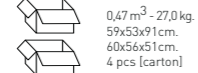

0,47 m³ - 27,0 kg.
59x53x91 cm.
60x56x51 cm.
4 pcs [carton]

Frame Finishing & Codes / Finiture Telai e Codici

cod.235.--/66ST chromed/cromata
cod.235.--/66STB white/bianco
cod.235.--/66STN black/nero

€ 430,00
€ 480,00
€ 480,00

COLORFIVE UPHOLSTERED IMBOTTITI

COLORFIVE WRAP ST 76



Upholstered Techno-polymer seat and chromed or painted frame.
Sgabello con seduta in tecnopolimero rivestito e telaio in metallo cromato o verniciato.

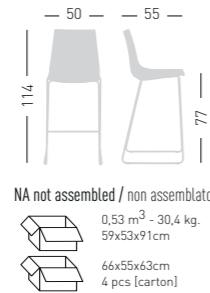

NA not assembled / non assemblato

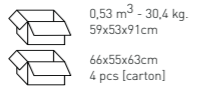

0,53 m³ - 30,4 kg.
59x53x91 cm.
66x55x63 cm.
4 pcs [carton]

Frame Finishing & Codes / Finiture Telai e Codici

cod.235.--/IE76ST chromed/cromata
cod.235.--/IE76STB white/bianco
cod.235.--/IE76STN black/nero
cod.235.--/IK76ST chromed/cromata
cod.235.--/IK76STB white/bianco
cod.235.--/IK76STN black/nero
cod.235.--/IB76ST chromed/cromata
cod.235.--/IB76STB white/bianco
cod.235.--/IB76STN black/nero
cod.235/ITC76ST chromed/cromata
cod.235/ITC76STB white/bianco
cod.235/ITC76STN black/nero

€ 512,00
€ 564,00
€ 564,00
€ 512,00
€ 564,00
€ 564,00
€ 536,00
€ 588,00
€ 588,00
€ 488,00
€ 312,00
€ 312,00

Fabric required
Fabbisogno di tessuto
1 pcs : Lin Mtrs 1 (h1,40)

COM fabric min. order
10pcs each code
Tessuto cliente TC ordine
min. 10pz per codice

Min. order 4pcs
each code
Ordine min 4pz
per codice

COLORFIVE WRAP ST 66



Upholstered Techno-polymer seat and chromed or painted frame.
Sgabello con seduta in tecnopolimero rivestito e telaio in metallo cromato o verniciato.

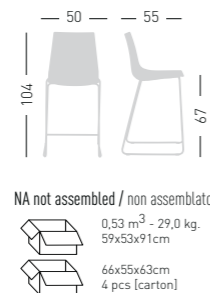

NA not assembled / non assemblato

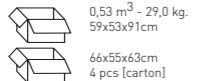

0,53 m³ - 29,0 kg.
59x53x91 cm.
66x55x63 cm.
4 pcs [carton]

Frame Finishing & Codes / Finiture Telai e Codici

cod.235.--/IE66ST chromed/cromata
cod.235.--/IE66STB white/bianco
cod.235.--/IE66STN black/nero
cod.235.--/IK66ST chromed/cromata
cod.235.--/IK66STB white/bianco
cod.235.--/IK66STN black/nero
cod.235.--/IB66ST chromed/cromata
cod.235.--/IB66STB white/bianco
cod.235.--/IB66STN black/nero
cod.235/ITC66ST chromed/cromata
cod.235/ITC66STB white/bianco
cod.235/ITC66STN black/nero

€ 512,00
€ 564,00
€ 564,00
€ 512,00
€ 564,00
€ 564,00
€ 536,00
€ 588,00
€ 588,00
€ 488,00
€ 312,00
€ 312,00

Fabric required
Fabbisogno di tessuto
1 pcs : Lin Mtrs 1 (h1,40)

COM fabric min. order
10pcs each code
Tessuto cliente TC ordine
min. 10pz per codice

Min. order 4pcs
each code
Ordine min 4pz
per codice



CROSS UPHOLSTERED



Leather seat and chromed metal frame.
Seduta in pelle.
Telaio in metallo cromato.

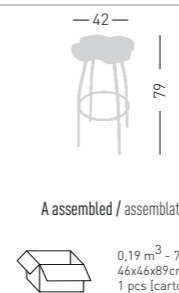

A assembled / assemblato



0,19 m³ - 7 kg.
46x46x89 cm.
1 pcs [carton]

Frame Finishing & Codes / Finiture Telai e Codici

cod.91.--/IEA chromed/cromato
cod.91.--/ITCA chromed/cromato

€ 246,00
€ 220,00

Fabric required
Fabbisogno di tessuto
1 pcs: Lin Mtrs 0,7 (h1,40)

COM fabric min. order
10pcs each code
Tessuto cliente TC ordine
min. 10pz per codice

Min. order 4pcs
each code
Ordine min 4pz
per codice

Dame Stool



Available coverings / Finiture disponibili
 King fabric / Tessuto King **K** (4pcs min.)
 Blazer fabric / Tessuto Blazer **B** (4pcs min.)
 Superb Trevira Velvet / Velluto Superb Trevira **S** (4pcs min.)
 Kvadrat fabrics / Tessuti Kvadrat **DK** (4pcs min.)
 Silvertex Fabric / Tessuto Silvertex **SX** (4pcs min.)
 Aurea eco-leather / Ecopelle Aurea **E** (4pcs min.)
 Maglia fabric / Tessuto Maglia **MG** (4pcs min.)
 COM fabric / Tessuto Cliente **TC** (10pcs min.)

Available Shell Color / Colori disponibili Scocca

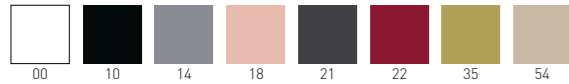

DAME S 68



Chromed wire steel frame, techno-polymer shell and upholstered cushion.
 Struttura a slitta in filo cromata, scocca in tecnopolimero e cuscino tappezzato.

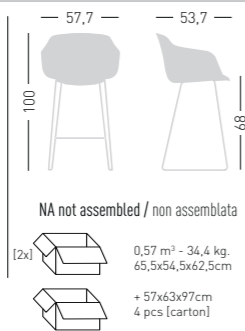

Frame Finishing & Codes / Finiture Telaie e Codici

cod. 267.__(K)_/ 68S chromed/cromata	€ 564,00
cod. 267.__(B)_/ 68S chromed/cromata	€ 576,00
cod. 267.__(S)_/ 68S chromed/cromata	€ 576,00
cod. 267.__(DK)_/ 68S chromed/cromata	€ 588,00
cod. 267.__(SX)_/ 68S chromed/cromata	€ 568,00
cod. 267.__(E)_/ 68S chromed/cromata	€ 542,00
cod. 267.__(MG)_/ 68S chromed/cromata	€ 568,00
cod. 267.__(TC)/ 68S chromed/cromata	€ 548,00

Fabric required
 Fabbisogno di tessuto
 4 pcs: Lin Mtrs 1,0 (h1,40)

COM fabric min. order
 10pcs each code
 Tessuto cliente TC ordine
 min. 10pz per codice

Min. order 4pcs
 each code
 Ordine min 4pz
 per codice

Available Frame Colors / Colori disponibili Telaio



DAME UPHOLSTERED IMBOTTITI

Available coverings / Finiture disponibili
 King fabric / Tessuto King **K** (4pcs min.)
 Blazer fabric / Tessuto Blazer **B** (4pcs min.)
 Superb Trevira Velvet / Velluto Superb Trevira **S** (4pcs min.)
 Kvadrat fabrics / Tessuti Kvadrat **DK** (4pcs min.)
 Aurea eco-leather / Ecopelle Aurea **E** (4pcs min.)
 Leather / Pelle **P** (4pcs min.)
 COM fabric / Tessuto Cliente **TC** (10pcs min.)

DRESS DAME S 68 Chromed wire steel frame, padded and upholstered shell.
 Struttura a slitta in filo cromata, scocca imbottita e rivestita.

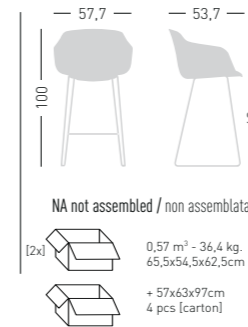

Frame Finishing & Codes / Finiture Telaie e Codici

cod. 267.__(IK68S) chromed/cromata	€ 858,00
cod. 267.__(IB68S) chromed/cromata	€ 922,00
cod. 267.__(IS68S) chromed/cromata	€ 922,00
cod. 267.__(IDK68S) chromed/cromata	€ 1.018,00
cod. 267.__(IE68S) chromed/cromata	€ 858,00
cod. 267.__(IP68S) chromed/cromata	€ 1.018,00
cod. 267.__(ITC68S) chromed/cromata	€ 818,00

Fabric required
 Fabbisogno di tessuto
 1 pc: Lin Mtrs 1,8 (h1,40)

COM fabric min. order
 10pcs each code
 Tessuto cliente TC ordine
 min. 10pz per codice

Min. order 4pcs
 each code
 Ordine min 4pz
 per codice

Available Frame Colors / Colori disponibili Telaio





Easy

Available colors / Colori disponibili

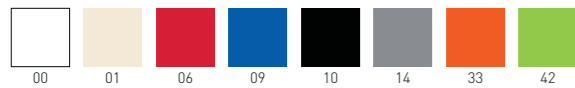

EASY 77



Techno-polymer seat, stackable chromed or painted for outdoor frame.

Seduta in tecnopolimero, telaio impilabile cromato o verniciato per esterno.



only for painted frames
solo per telai verniciati

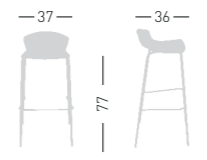

stackable / impilabile (5pcs)
NA not assembled / non assemblato



0,240 m³ - 19,8 kg.
91x59x43cm.
4 pcs [carton]

Frame Finishing & Codes / Finiture Telai e Codici

cod. 58.-- / 77 NA chromed/cromata

cod. 58.-- / 77 NAN black painted/verniciato nero

cod. 58.-- / 77 NAB white painted/verniciato bianco

€ 182,00

€ 218,00

€ 218,00

EASY 67



Techno-polymer seat, stackable chromed or painted for outdoor frame.

Seduta in tecnopolimero, telaio impilabile cromato o verniciato per esterno.



only for painted frames
solo per telai verniciati

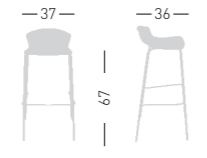

stackable / impilabile (5pcs)
NA not assembled / non assemblato



0,240 m³ - 19 kg.
91x59x43cm.
4 pcs [carton]

Frame Finishing & Codes / Finiture Telai e Codici

cod. 58.-- / 67 NA chromed/cromata

cod. 58.-- / 67 NAN black painted/verniciato nero

cod. 58.-- / 67 NAB white painted/verniciato bianco

€ 182,00

€ 218,00

€ 218,00



Fix

Available colors / Colori disponibili



FIX



Techno-polymer seat, chromed frame and combined base.
Seduta in tecnopolimero, telaio cromato e base abbinata.

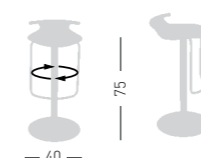

A assembled / assemblato



0,19 m³ - 11,2 kg.
46x46x89cm
1 pcs [carton]

Frame Finishing & Codes / Finiture Telai e Codici

cod. 32.-- /AF

Base color combined with the seat
Colore base abbinata alla seduta

€ 266,00

FIX AV



Techno-polymer seat, chromed frame and base.
Seduta in tecnopolimero, telaio cromato e base cromata.

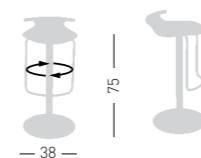

A assembled / assemblato



0,19 m³ - 11,2 kg.
46x46x89cm
1 pcs [carton]

Frame Finishing & Codes / Finiture Telai e Codici

cod.32.--/AFV chromed base/base cromata

€ 314,00

Format



Available colors / Colori disponibili

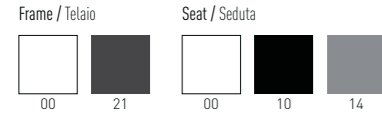

FORMAT

Bench with compact seat and outdoor painted metal frame.
Panca con seduta in compact e telaio in metallo verniciato per esterno.

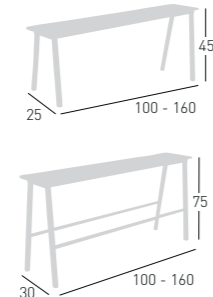

NA not assembled / non assemblato



0,47 m³ - 20kg.
1 pcs [carton]

0,47 m³ - 22 kg.
1 pcs [carton]

0,60 m³ - 27 kg.
1 pcs [carton]

0,60 m³ - 29 kg.
1 pcs [carton]

Frame Finishing & Codes / Finiture Telai e Codici

cod.BFORC848._._/H45 100x30 € **550,00**

cod.BFORC848._._/H75 100x30 € **580,00**

H75cm Bench with footrail
Panca Altezza 75cm con poggiaiedi € **610,00**

cod.BFORC849._._/H75 160x30 € **670,00**

H75cm Bench with footrail
Panca Altezza 75cm con poggiaiedi

FORMAT UPHOLSTERED IMBOTTITE

Available coverings / Finiture disponibili
Aurea eco-leather / Ecopelle aurea **E** (4pcs min.)
King fabric / Tessuto King **K** (4pcs min.)
COM fabric / Tessuto cliente **TC** (10pcs min.)

FORMAT UPH

Upholstered bench, painted metal frame.
Panca con seduta tappezzata e telaio in metallo verniciato.

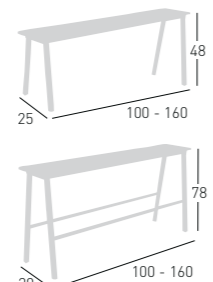

NA not assembled / non assemblato



0,38 m³ - 15 kg.
160x80x30cm.
1 pcs [carton]

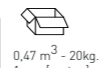

0,47 m³ - 20kg.
1 pcs [carton]

0,47 m³ - 22 kg.
1 pcs [carton]

0,60 m³ - 27 kg.
1 pcs [carton]

0,60 m³ - 29 kg.
1 pcs [carton]

Frame Finishing & Codes / Finiture Telai e Codici

cod.BFORC848._._/IEH48 100x30 € **670,00**

cod.BFORC848._._/IKH48 100x30 € **670,00**

cod.BFORC848/ITCH48 100x30 € **610,00**

cod.BFORC848._._/IEH78 100x30 € **704,00**

cod.BFORC848._._/IKH78 100x30 € **704,00**

cod.BFORC848/ITCH78 100x30 € **640,00**

H78cm Bench with footrail
Panca Altezza 78cm con poggiaiedi

cod.BFORC849._._/IEH48 160x30 € **732,00**

cod.BFORC849._._/IKH48 160x30 € **732,00**

cod.BFORC849/ITCH48 160x30 € **670,00**

cod.BFORC849._._/IEH78 160x30 € **792,00**

cod.BFORC849._._/IKH78 160x30 € **792,00**

cod.BFORC849/ITCH78 160x30 € **732,00**

Fabric required
Fabbisogno di tessuto COM fabric min. order Min. order 4pcs
1 pcs: Lin Mtrs 1 [h1,40] 10pcs each code each code
2 pcs: Lin Mtrs 2 [h1,40] Tessuto cliente TC ordine Ordine min 4pz
min. 10pz per codice per codice

Free



Available colors / Colori disponibili

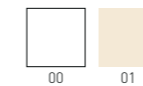

FREE

Techno-polymer seat, chromed frame and combined base.
Seduta in tecnopolimero, telaio cromato e base abbinata.

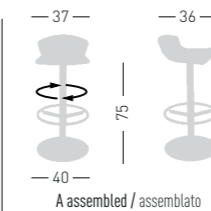

A assembled / assemblato



0,19 m³ - 11 kg.
46x46x89cm
1 pcs [carton]

Frame Finishing & Codes / Finiture Telai e Codici

cod. 57.-- /A

Base color combined with the seat
Colore base abbinata alla seduta

€ **240,00**

FREE AV

Techno-polymer seat, chromed frame and base.
Seduta in tecnopolimero, telaio cromato e base cromata.

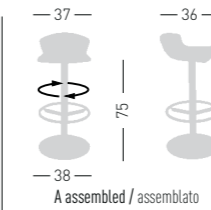

A assembled / assemblato



0,19 m³ - 12 kg.
46x46x89cm
1 pcs [carton]

Frame Finishing & Codes / Finiture Telai e Codici

cod.57.--/AV chromed base/base cromata

€ **290,00**



Freedom

Available colors / Colori disponibili

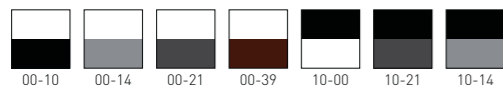

Frame / Telaio
Seat / Seduta

FREEDOM



Techno-polymer seat and frame, chromed or satin base.
Seduta e telaio in tecnopolimero, base cromata o satinata.

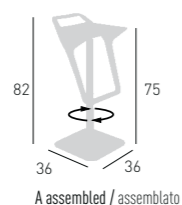

A assembled / assemblato



0,19 m³ - 16 kg.
46x46x89cm.
1 pcs [carton]

Frame Finishing & Codes / Finiture Telaio e Codici

cod.136.--/A chromed base/base cromata
cod.136.--/AS satin base/base satinata

€ 558,00
€ 672,00

FREEDOM



Techno-polymer seat and frame, chromed or satin base height adjustment.
Seduta e telaio in tecnopolimero, base cromata o satinata, regolabile in altezza.

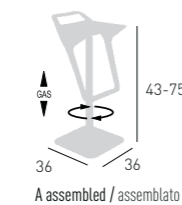

A assembled / assemblato



0,12 m³ - 16,2 kg.
42,5x45x60cm.
1 pcs [carton]

Frame Finishing & Codes / Finiture Telaio e Codici

cod.99.--/A chromed base/base cromata
cod.99.--/AS satin base/base satinata

€ 558,00
€ 672,00

Fuller



Available colors / Colori disponibili



FULLER 75



Stackable techno-polymer stool, outdoor painted frame.
Sgabello impilabile con seduta in tecnopolimero e telaio in metallo verniciato per esterno.



Legs and shell colors can be combined.
I colori della struttura e della scocca possono essere abbinati.

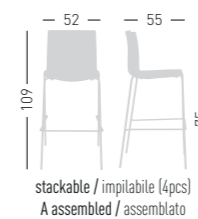

stackable / impilabile (4pcs)
A assembled / assemblato



0,43 m³ - 15 kg.
60x61x118cm.
2 pcs [carton]

Frame Finishing & Codes / Finiture Telaio e Codici

cod.379.__/75AB
cod.379.__/75AN
cod.379.__/75AG
cod.379.__/75A06
cod.379.__/75A02
cod.379.__/75A16

€ 304,00
€ 304,00
€ 304,00
€ 304,00
€ 304,00
€ 304,00

FULLER 65



Stackable techno-polymer stool, outdoor painted frame.
Sgabello impilabile con seduta in tecnopolimero e telaio in metallo verniciato per esterno.



Legs and shell colors can be combined.
I colori della struttura e della scocca possono essere abbinati.

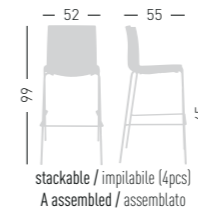

stackable / impilabile (4pcs)
A assembled / assemblato



0,43 m³ - 14,5 kg.
60x61x118cm.
2 pcs [carton]

Frame Finishing & Codes / Finiture Telaio e Codici

cod.379.__/65AB
cod.379.__/65AN
cod.379.__/65AG
cod.379.__/65A06
cod.379.__/65A02
cod.379.__/65A16

€ 304,00
€ 304,00
€ 304,00
€ 304,00
€ 304,00
€ 304,00



Available colors / Colori disponibili

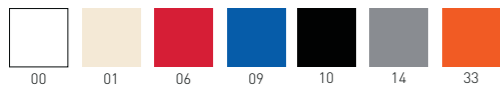

GULIVER

Techno-polymer seat, chromed frame and combined base. Seduta in tecnopolimero, telaio cromato e base abbinata.

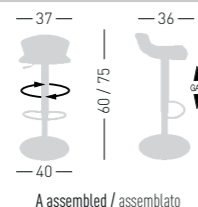

Frame Finishing & Codes / Finiture Telai e Codici

cod. 56.-- /A

Base color combined with the seat
Colore base abbinata alla seduta

€ **314,00**

GULIVER AV

Techno-polymer seat, chromed frame and base. Seduta in tecnopolimero, telaio cromato e base cromata.

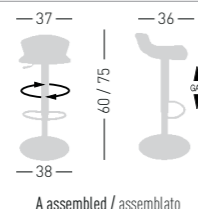

Frame Finishing & Codes / Finiture Telai e Codici

cod.56.--/AV chromed base/base cromata

€ **368,00**



Available colors / Colori disponibili

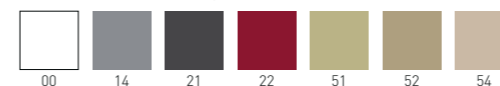

ISIDORO 76

Co-injected metal-polymer stackable stool. Sgabello impilabile in co-iniezione polimero-metallo.

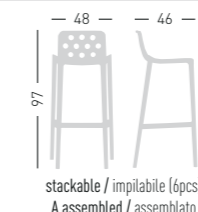

Frame Finishing & Codes / Finiture Telai e Codici

cod.382.--/76A

€ **218,00**

ISIDORO 66

Co-injected metal-polymer stackable stool. Sgabello impilabile in co-iniezione polimero-metallo.

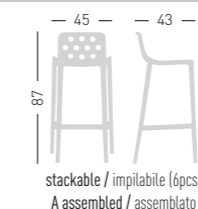

Frame Finishing & Codes / Finiture Telai e Codici

cod.382.--/66A

€ **218,00**

ISIDORO CUSHION / CUSCINO

Upholstered cushion. Cuscino tappezzato.



Available fabric. Tessuti disponibili. **E, K** (4 psc min) COM fabric / Tessuto cliente **TC** (10 psc min)



Frame Finishing & Codes / Finiture Telai e Codici

cod.313.--
cod.312.TC COM fabric/tessuto cliente

€ **106,00**
€ **92,00**

Fabric required
Fabbisogno di tessuto
4 pcs: Lin Mtrs 1,0 (h1,40)

COM fabric min. order
10pcs each code
Tessuto cliente TC ordine
min. 10pz per codice

Min. order 4pcs
each code
Ordine min 4pz
per codice

ISIDORO UPHOLSTERED IMBOTTITI

ISIDORO 76 UPHOLSTERED



Upholstered co-injected metal-polymer stool.
Sgabello in co-iniezione polimero-metallo rivestito.

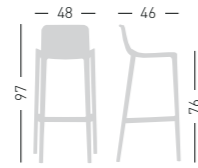

NA seat panel not assembled /
cuscino non assemblato
0,36 m³ - 23,2 kg.
62,5x49x116cm.
4 pcs [carton]

Frame Finishing & Codes / Finiture Telai e Codici

cod.382.--.--/IE76A	€	452,00
cod.382.--.--/IK76A	€	452,00
cod.382.--.--/ITC76A COM fabric/tessuto cliente	€	416,00

Fabric required
Fabbisogno di tessuto
2 pcs: Lin Mtrs 1 (h1,40)

COM fabric min. order
10pcs each code
Tessuto cliente TC ordine
min. 10pz per codice

Min. order 4pcs
each code
Ordine min 4pz
per codice

Glossy back coverings colors can be combined with the stool frame.
I colori dei retro-schienali lucidi possono essere abbinati al telaio sgabello.

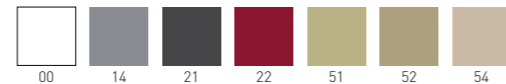

ISIDORO 66 UPHOLSTERED



Upholstered co-injected metal-polymer stool.
Sgabello in co-iniezione polimero-metallo rivestito.

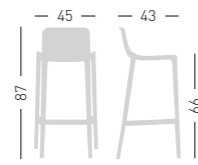

NA seat panel not assembled /
cuscino non assemblato
0,36 m³ - 22,4 kg.
62,5x49x116cm.
4 pcs [carton]

Frame Finishing & Codes / Finiture Telai e Codici

cod.382.--.--/IE66A	€	452,00
cod.382.--.--/IK66A	€	452,00
cod.382.--.--/ITC+6A COM fabric/tessuto cliente	€	416,00

Fabric required
Fabbisogno di tessuto
2 pcs: Lin Mtrs 1 (h1,40)

COM fabric min. order
10pcs each code
Tessuto cliente TC ordine
min. 10pz per codice

Min. order 4pcs
each code
Ordine min 4pz
per codice

Glossy back coverings colors can be combined with the stool frame.
I colori dei retro-schienali lucidi possono essere abbinati al telaio sgabello.



Available coverings / Finiture disponibili
Aurea eco-leather / Ecopelle Aurea **E** (4pcs min.)
King fabric / Tessuto King **K** (4pcs min.)
COM fabric / Tessuto cliente **TC** (10pcs min.)

Joy



Available colors / Colori disponibili

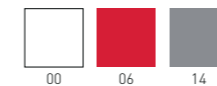

JOY



Techno-polymer seat,
chromed frame and combined base.
Seduta in tecnopolimero,
telaio cromato e base abbinata.

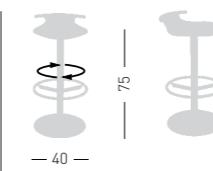

A assembled / assemblato

0,19 m³ - 11 kg.
46x46x89cm
1 pcs [carton]

Frame Finishing & Codes / Finiture Telai e Codici

cod. 43.-- /A

Base color combined with the seat
Colore base abbinata alla seduta

€ **240,00**

JOY AV



Techno-polymer seat,
chromed frame and base.
Seduta in tecnopolimero, telaio
cromato e base cromata.

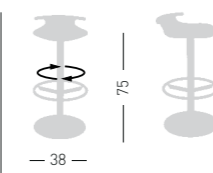

A assembled / assemblato

0,19 m³ - 11,5 kg.
46x46x89cm
1 pcs [carton]

Frame Finishing & Codes / Finiture Telai e Codici

cod.43.--/AV chromed base/base cromata

€ **290,00**

Jubel Stool



Available colors / Colori disponibili

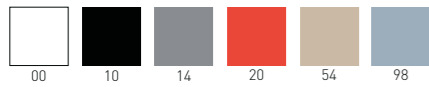

JUBEL ST 76



Techno-polymer seat and chromed or outdoor painted stackable frame.
Sgabello con seduta in tecnopolimero e telaio impilabile in metallo cromato o verniciato per esterno.



only for paintend frames
solo per telai verniciati

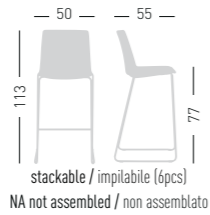

stackable / impilabile (6pcs)
NA not assembled / non assemblato

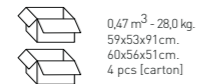

Frame Finishing & Codes / Finiture Telai e Codici

cod. 199. / 76ST chromed/cromata
cod. 199. / 76STB white painted/verniciato bianco
cod. 199. / 76STN black painted/verniciato nero

€ 268,00
€ 320,00
€ 320,00

JUBEL ST 66



Techno-polymer seat and chromed or outdoor painted stackable frame.
Sgabello con seduta in tecnopolimero e telaio impilabile in metallo cromato o verniciato per esterno.



only for paintend frames
solo per telai verniciati

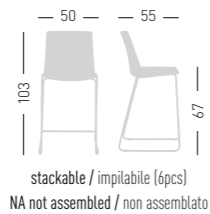

stackable / impilabile (6pcs)
NA not assembled / non assemblato

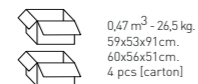

Frame Finishing & Codes / Finiture Telai e Codici

cod. 199. / 66ST chromed/cromata
cod. 199. / 66STB white painted/verniciato bianco
cod. 199. / 66STN black painted/verniciato nero

€ 268,00
€ 320,00
€ 320,00

JUBEL HS 05R



Swivel on 5-blade painted aluminum base with castors, height adjustable, adjustable footring, technopolymer shell.
Girevole su basamento 5 razze in alluminio verniciato con ruote, regolabile in altezza, poggiatesta regolabile, scocca in tecnopolimero.

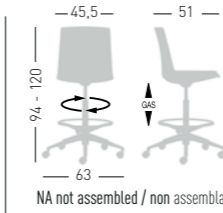

NA not assembled / non assemblato



Frame Finishing & Codes / Finiture Telai e Codici

cod. 199. / HS05RN black painted/verniciata nera
cod. 199. / HS05R polished/pulita

€ 442,00
€ 456,00

JUBEL CUSHION / CUSCINO



Upholstered cushion.
Cuscino tappezzato.

Available fabric.
Tessuti disponibili.
B, E, K, DK
COM fabric / Tessuto cliente **TC**



0,5 kg.
Inside stools
boxes
Nella scatola
degli sgabelli.

Frame Finishing & Codes / Finiture Telai e Codici

cod. 315. (B)
cod. 315. (E)
cod. 315. (K)
cod. 315. (DK)
cod. 315.TC COM fabric/tessuto cliente

€ 122,00
€ 106,00
€ 106,00
€ 130,00
€ 92,00

Fabric required
Fabbisogno di tessuto
4 pcs : Lin Mtrs 1 (h1,40)

COM fabric min. order
10pcs each code
Tessuto cliente TC ordine
min. 10pz per codice

Min. order 4pcs
each code
Ordine min 4pz
per codice

JUBEL UPHOLSTERED IMBOTTITI

Available coverings / Rivestimenti disponibili
Aurea eco-leather / Ecopelle Aurea **E** (4pcs min.)
King fabric / Tessuto King **K** (4pcs min.)
Kvadrat fabrics / Tessuti Kvadrat **DK** (4pcs min.)
COM fabric / Tessuto cliente **TC** (10pcs min.)

JUBEL ST 76 UPHOLSTERED



Upholstered Techno-polymer seat, chromed or painted frame.
Sgabello con seduta in tecnopolimero rivestito e telaio in metallo cromato o verniciato.

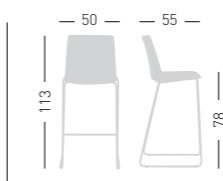

NA not assembled / non assemblato

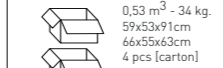

Frame Finishing & Codes / Finiture Telai e Codici

cod. 199. / IE76ST chromed/cromata
cod. 199. / IE76TB white/bianco
cod. 199. / IE76STN black/nero
cod. 199. / IK76ST chromed/cromata
cod. 199. / IK76TB white/bianco
cod. 199. / IK76STN black/nero
cod. 199. / IDK76ST chromed/cromata
cod. 199. / IDK76TB white/bianco
cod. 199. / IDK76STN black/nero
cod. 199. / ITC76ST chromed/cromata
cod. 199. / ITC76TB white/bianco
cod. 199. / ITC76STN black/nero

€ 464,00
€ 514,00
€ 514,00
€ 464,00
€ 514,00
€ 514,00
€ 652,00
€ 652,00
€ 414,00
€ 464,00
€ 464,00

Fabric required
Fabbisogno di tessuto
1 pcs: Lin Mtrs 1 (h1,40)

COM fabric min. order
10pcs each code
Tessuto cliente TC ordine
min. 10pz per codice

Min. order 4pcs
each code
Ordine min 4pz
per codice

JUBEL ST 66 UPHOLSTERED



Upholstered Techno-polymer seat, chromed or painted frame.
Sgabello con seduta in tecnopolimero rivestito e telaio in metallo cromato o verniciato.

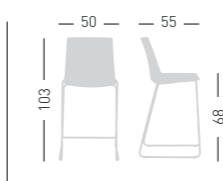

NA not assembled / non assemblato

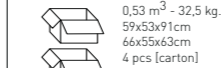

Frame Finishing & Codes / Finiture Telai e Codici

cod. 199. / IE66ST chromed/cromata
cod. 199. / IE66TB white/bianco
cod. 199. / IE66STN black/nero
cod. 199. / IK66ST chromed/cromata
cod. 199. / IK66TB white/bianco
cod. 199. / IK66STN black/nero
cod. 199. / IDK66ST chromed/cromata
cod. 199. / IDK66TB white/bianco
cod. 199. / IDK66STN black/nero
cod. 199. / ITC66ST chromed/cromata
cod. 199. / ITC66TB white/bianco
cod. 199. / ITC66STN black/nero

€ 464,00
€ 514,00
€ 514,00
€ 464,00
€ 514,00
€ 514,00
€ 600,00
€ 652,00
€ 652,00
€ 414,00
€ 464,00
€ 464,00

Fabric required
Fabbisogno di tessuto
1 pcs: Lin Mtrs 1 (h1,40)

COM fabric min. order
10pcs each code
Tessuto cliente TC ordine
min. 10pz per codice

Min. order 4pcs
each code
Ordine min 4pz
per codice

JUBEL BST 76
UPHOLSTERED



Upholstered Techno-polymer seat, chromed or painted frame.
Sgabello con seduta in tecnopolimero rivestito e telaio in metallo cromato o verniciato.

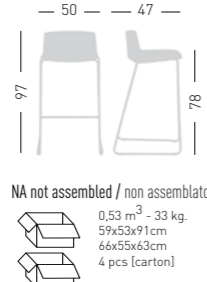

NA not assembled / non assemblato
0,53 m³ - 33 kg.
59x53x91cm
66x55x63cm
4 pcs (carton)

Frame Finishing & Codes / Finiture Telaie e Codici

cod. 198. /IE76ST chromed/cromata	€ 464,00
cod. 198. /IE76STB white/bianco	€ 514,00
cod. 198. /IE76STN black/nero	€ 514,00
cod. 198. /IK76ST chromed/cromata	€ 464,00
cod. 198. /IK76STB white/bianco	€ 514,00
cod. 198. /IK76STN black/nero	€ 514,00
cod. 198. /IDK76ST chromed/cromata	€ 600,00
cod. 198. /IDK76STB white/bianco	€ 652,00
cod. 198. /IDK76STN black/nero	€ 652,00
cod. 198. /ITC76ST chromed/cromata	€ 414,00
cod. 198. /ITC76STB white/bianco	€ 464,00
cod. 198. /ITC76STN black/nero	€ 464,00

Fabric required
Fabbisogno di tessuto
1 pcs: Lin Mtrs 0,8 (h1,40)

COM fabric min. order
10pcs each code
Tessuto cliente TC ordine
min. 10pz per codice

Min. order 4pcs
each code
Ordine min 4pz
per codice

JUBEL BST 66
UPHOLSTERED



Upholstered Techno-polymer seat, chromed or painted frame.
Sgabello con seduta in tecnopolimero rivestito e telaio in metallo cromato o verniciato.

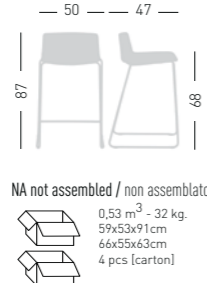

NA not assembled / non assemblato
0,53 m³ - 32 kg.
59x53x91cm
66x55x63cm
4 pcs (carton)

Frame Finishing & Codes / Finiture Telaie e Codici

cod. 198. /IE66ST chromed/cromata	€ 464,00
cod. 198. /IE66STB white/bianco	€ 514,00
cod. 198. /IE66STN black/nero	€ 514,00
cod. 198. /IK66ST chromed/cromata	€ 464,00
cod. 198. /IK66STB white/bianco	€ 514,00
cod. 198. /IK66STN black/nero	€ 514,00
cod. 198. /IDK66ST chromed/cromata	€ 600,00
cod. 198. /IDK66STB white/bianco	€ 652,00
cod. 198. /IDK66STN black/nero	€ 652,00
cod. 198. /ITC66ST chromed/cromata	€ 414,00
cod. 198. /ITC66STB white/bianco	€ 464,00
cod. 198. /ITC66STN black/nero	€ 464,00

Fabric required
Fabbisogno di tessuto
1 pcs: Lin Mtrs 0,8 (h1,40)

COM fabric min. order
10pcs each code
Tessuto cliente TC ordine
min. 10pz per codice

Min. order 4pcs
each code
Ordine min 4pz
per codice

JUBEL HS 05R
UPHOLSTERED



Upholstered Techno-polymer seat, swivel on 5-blade painted aluminum base with castors, height adjustable, adjustable footring.
Sgabello con seduta in tecnopolimero rivestito, girevole su basamento 5 razze in alluminio verniciato con ruote, regolabile in altezza, poggiatesta regolabile.

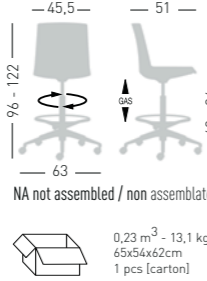

NA not assembled / non assemblato
0,23 m³ - 13,1 kg.
65x54x62cm
1 pcs (carton)

Frame Finishing & Codes / Finiture Telaie e Codici

cod. 199. /IEHS05RN black painted/verniciato nero	€ 662,00
cod. 199. /IEHS05R polished/pulita	€ 676,00
cod. 199. /IKHS05RN black painted/verniciata nera	€ 662,00
cod. 199. /IKHS05R polished/pulita	€ 676,00
cod. 199. /IDKHS05RN black painted/verniciata nera	€ 798,00
cod. 199. /IDKHS05R polished/pulita	€ 810,00
cod. 199. /ITCHS05RN black painted/verniciata nera	€ 612,00
cod. 199. /ITCHS05R polished/pulita	€ 624,00



Available colors / Colori disponibili

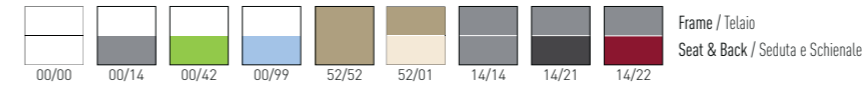

KALIPA



Techno-polymer twin material stool.
Sgabello realizzato in tecnopolimero bi-materiale.

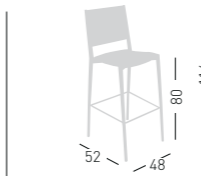

NA not assembled / non assemblato
0,43 m³ - 33 kg.
61x54x20cm
54x54x125cm
4 pcs (carton)

Frame Finishing & Codes / Finiture Telaie e Codici

cod.275.-- --/NA	€ 310,00
------------------	----------

KALIPA B



Techno-polymer twin material stool with integrated armrest.
Sgabello realizzato in tecnopolimero bi-materiale con braccioli.

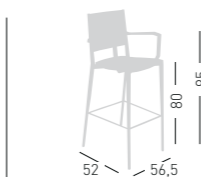

NA not assembled / non assemblato
0,48 m³ - 35,2 kg.
61x54x20cm
54x64x120cm
4 pcs (carton)

Frame Finishing & Codes / Finiture Telaie e Codici

cod.276.-- --/NA	€ 382,00
------------------	----------

KALIPA CUSHION / CUSCINO

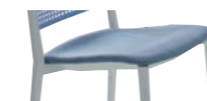

Upholstered cushion.
Cuscino tappezzato.

Available fabric.
Tessuti disponibili.

E, K
COM fabric / Tessuto cliente TC (10pcs min.)

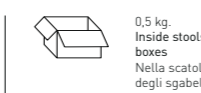

0,5 kg.
Inside stools boxes
Nella scatola degli sgabelli

Frame Finishing & Codes / Finiture Telaie e Codici

cod.306.--	€ 96,00
cod.306.TC COM fabric/tessuto cliente	€ 88,00

Fabric required
Fabbisogno di tessuto
4 pcs: Lin Mtrs 1,0 (h1,40)

COM fabric min. order
10pcs each code
Tessuto cliente TC ordine
min. 10pz per codice

Min. order 4pcs
each code
Ordine min 4pz
per codice

Kanvas



Available colors / Colori disponibili

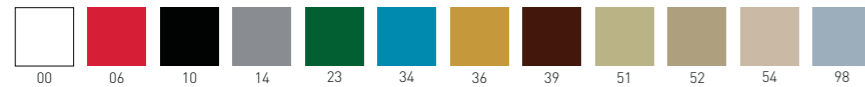

KANVAS ST 76



Techno-polymer seat and chromed or outdoor painted stackable frame. Sgabello impilabile con seduta in tecnopolimero e telaio in metallo cromato o verniciato per esterno.



only for paintend frames
solo per telai verniciati

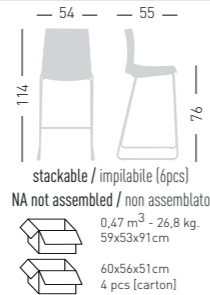

stackable / impilabile (6pcs)
NA not assembled / non assemblato
0,47 m³ - 26,8 kg.
59x53x91 cm
60x56x51 cm
4 pcs [carton]

Frame Finishing & Codes / Finiture Telai e Codici

cod.362.--/76ST chromed/cromata
cod.362.--/76STB white painted/verniciato bianco
cod.362.--/76STN black painted/verniciato nero

€ 256,00
€ 310,00
€ 310,00

KANVAS ST 66



Techno-polymer seat and chromed or outdoor painted stackable frame. Sgabello impilabile con seduta in tecnopolimero e telaio in metallo cromato o verniciato per esterno.



only for paintend frames
solo per telai verniciati

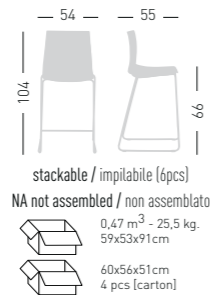

stackable / impilabile (6pcs)
NA not assembled / non assemblato
0,47 m³ - 25,5 kg.
59x53x91 cm
60x56x51 cm
4 pcs [carton]

Frame Finishing & Codes / Finiture Telai e Codici

cod.362.--/66ST chromed/cromata
cod.362.--/66STB white painted/verniciato bianco
cod.362.--/66STN black painted/verniciato nero

€ 256,00
€ 310,00
€ 310,00

KANVAS CUSHION / CUSCINO



Kanvas Upholstered cushion. Cuscino tappezzato Kanvas.

Available fabric. Tessuti disponibili. E, K, DK (4pcs min.) COM fabric / Tessuto cliente TC (10pcs min.)



0,5 kg
Inside stools boxes
Nella scatola degli sgabelli

Frame Finishing & Codes / Finiture Telai e Codici

cod.317.--
cod.317.--/DK
cod.317.TC COM fabric/tessuto cliente

€ 116,00
€ 144,00
€ 102,00

Fabric required
Fabbisogno di tessuto
4 pcs: Lin Mtrs 1,0 (h1,40)

COM fabric min. order
10pcs each code
Tessuto cliente TC ordine
min. 10pz per codice

Min. order 4pcs
each code
Ordine min 4pz
per codice

KANVAS UPHOLSTERED IMBOTTITI

KANVAS ST 76 FRONT UPHOLSTERED



Upholstered Techno-polymer seat, chromed or painted frame. Sgabello con seduta in tecnopolimero rivestito, telaio in metallo cromato o verniciato.

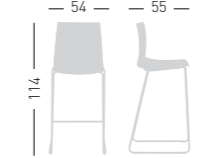

NA not assembled / non assemblato
0,53 m³ - 31,6 kg.
59x53x91 cm
66x55x63 cm
4 pcs [carton]

Colours shell / Colori scocca



Frame Finishing & Codes / Finiture Telai e Codici

cod.363.--/IE76ST chromed/cromata
cod.363.--/IE76STB white/bianco
cod.363.--/IE76STN black/nero
cod.363.--/IK76ST chromed/cromata
cod.363.--/IK76STB white/bianco
cod.363.--/IK76STN black/nero
cod.363.--/IB76ST chromed/cromata
cod.363.--/IB76STB white/bianco
cod.363.--/IB76STN black/nero
cod.363.--/IDK76ST chromed/cromata
cod.363.--/IDK76STB white/bianco
cod.363.--/IDK76STN black/nero
cod.363/ITC76ST chromed/cromata
cod.363/ITC76STB white/bianco
cod.363/ITC76STN black/nero

€ 426,00
€ 482,00
€ 482,00
€ 426,00
€ 482,00
€ 482,00
€ 466,00
€ 524,00
€ 524,00
€ 576,00
€ 632,00
€ 632,00
€ 370,00
€ 426,00
€ 426,00

Fabric required
Fabbisogno di tessuto
1 pcs: Lin Mtrs 0,8 (h1,40)

COM fabric min. order
10pcs each code
Tessuto cliente TC ordine
min. 10pz per codice

Min. order 4pcs
each code
Ordine min 4pz
per codice

KANVAS ST 66 FRONT UPHOLSTERED



Upholstered Techno-polymer seat, chromed or painted frame. Sgabello con seduta in tecnopolimero rivestito, telaio in metallo cromato o verniciato.

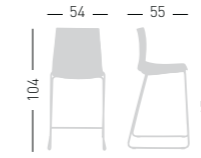

NA not assembled / non assemblato
0,53 m³ - 30,5 kg.
59x53x91 cm
66x55x63 cm
4 pcs [carton]

Colours shell / Colori scocca



Frame Finishing & Codes / Finiture Telai e Codici

cod.363.--/IE66ST chromed/cromata
cod.363.--/IE66STB white/bianco
cod.363.--/IE66STN black/nero
cod.363.--/IK66ST chromed/cromata
cod.363.--/IK66STB white/bianco
cod.363.--/IK66STN black/nero
cod.363.--/IB66ST chromed/cromata
cod.363.--/IB66STB white/bianco
cod.363.--/IB66STN black/nero
cod.363.--/IDK66ST chromed/cromata
cod.363.--/IDK66STB white/bianco
cod.363.--/IDK66STN black/nero
cod.363/ITC66ST chromed/cromata
cod.363/ITC66STB white/bianco
cod.363/ITC66STN black/nero

€ 426,00
€ 482,00
€ 482,00
€ 426,00
€ 482,00
€ 482,00
€ 466,00
€ 524,00
€ 524,00
€ 576,00
€ 632,00
€ 632,00
€ 370,00
€ 426,00
€ 426,00

Fabric required
Fabbisogno di tessuto
1 pcs: Lin Mtrs 0,8 (h1,40)

COM fabric min. order
10pcs each code
Tessuto cliente TC ordine
min. 10pz per codice

Min. order 4pcs
each code
Ordine min 4pz
per codice

KANVAS ST 76
FULL UPHOLSTERED



Upholstered Techno-polymer seat, chromed or painted frame.
Sgabello con seduta in tecnopolimero rivestito, telaio in metallo cromato o verniciato.

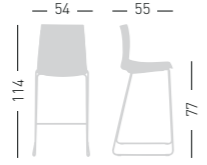

NA not assembled / non assemblato
0,53 m³ - 29,6 kg.
59x53x91cm
66x55x63cm
4 pcs [carton]

Frame Finishing & Codes / Finiture Telaie e Codici

cod.362.--/IE76ST chromed/cromata	€ 584,00
cod.362.--/IE76STB white/bianco	€ 638,00
cod.362.--/IE76STN black/nero	€ 638,00
cod.362.--/IK76ST chromed/cromata	€ 584,00
cod.362.--/IK76STB white/bianco	€ 638,00
cod.362.--/IK76STN black/nero	€ 638,00
cod.362.--/IB76ST chromed/cromata	€ 622,00
cod.362.--/IB76STB white/bianco	€ 680,00
cod.362.--/IB76STN black/nero	€ 680,00
cod.362.--/IDK76ST chromed/cromata	€ 732,00
cod.362.--/IDK76STB white/bianco	€ 790,00
cod.362.--/IDK76STN black/nero	€ 790,00
cod.362/ITC76ST chromed/cromata	€ 528,00
cod.362/ITC76STB white/bianco	€ 584,00
cod.362/ITC76STN black/nero	€ 584,00

Fabric required
Fabbisogno di tessuto
1 pcs : Lin Mtrs 1 (h1,40)

COM fabric min. order
10pcs each code
Tessuto cliente TC ordine
min. 10pz per codice

Min. order 4pcs
each code
Ordine min 4pz
per codice

KANVAS ST 66
FULL UPHOLSTERED



Upholstered Techno-polymer seat, chromed or painted frame.
Sgabello con seduta in tecnopolimero rivestito, telaio in metallo cromato o verniciato.

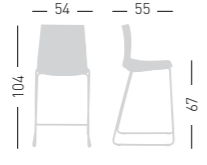

NA not assembled / non assemblato
0,53 m³ - 28,5 kg.
59x53x91cm
66x55x63cm
4 pcs [carton]

Frame Finishing & Codes / Finiture Telaie e Codici

cod.362.--/IE66ST chromed/cromata	€ 584,00
cod.362.--/IE66STB white/bianco	€ 638,00
cod.362.--/IE66STN black/nero	€ 638,00
cod.362.--/IK66ST chromed/cromata	€ 584,00
cod.362.--/IK66STB white/bianco	€ 638,00
cod.362.--/IK66STN black/nero	€ 638,00
cod.362.--/IB66ST chromed/cromata	€ 622,00
cod.362.--/IB66STB white/bianco	€ 680,00
cod.362.--/IB66STN black/nero	€ 680,00
cod.362.--/IDK66ST chromed/cromata	€ 732,00
cod.362.--/IDK66STB white/bianco	€ 790,00
cod.362.--/IDK66STN black/nero	€ 790,00
cod.362/ITC66ST chromed/cromata	€ 528,00
cod.362/ITC66STB white/bianco	€ 584,00
cod.362/ITC66STN black/nero	€ 584,00

Fabric required
Fabbisogno di tessuto
1 pcs : Lin Mtrs 1 (h1,40)

COM fabric min. order
10pcs each code
Tessuto cliente TC ordine
min. 10pz per codice

Min. order 4pcs
each code
Ordine min 4pz
per codice



Available shell color / Colori disponibili scocca



Frame finishes / Finiture telaio



KASIA STOOL 76



4-Legged metal stool, painted with special treatment for outdoor purpose, techno-polymer shell.
Sgabello con struttura 4 gambe in metallo verniciato con trattamento per esterno, scocca in tecnopolimero.

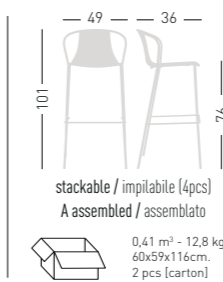

stackable / impilabile (4pcs)
A assembled / assemblato
0,41 m³ - 12,8 kg.
60x59x116cm.
2 pcs [carton]

Frame Finishing & Codes / Finiture Telaie e Codici

cod. 189. __/76A_ € 374,00

KASIA STOOL 66



4-Legged metal stool, painted with special treatment for outdoor purpose, techno-polymer shell.
Sgabello con struttura 4 gambe in metallo verniciato con trattamento per esterno, scocca in tecnopolimero.

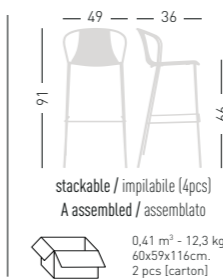

stackable / impilabile (4pcs)
A assembled / assemblato
0,41 m³ - 12,3 kg.
60x59x116cm.
2 pcs [carton]

Frame Finishing & Codes / Finiture Telaie e Codici

cod. 189. __/66A_ € 374,00

KASIA UPHOLSTERED IMBOTTITI



Suitable for outdoor purpose with MG finishes.
Adatto all'uso per esterni con finiture MG.

Available coverings / Finiture disponibili
King fabric / Tessuto King **K** (4pcs min.)
Maglia fabric / Tessuto Maglia **MG** (4pcs min.)
Superb Trevira Velvet / Velluto Superb Trevira **S** (4pcs min.)

KASIA STOOL 76 UPHOLSTERED



4-Legged metal stool, painted with special treatment for outdoor purpose, padded and upholstered shell.
Sgabello con struttura 4 gambe in metallo verniciato con trattamento per esterno, scocca imbottita e rivestita.

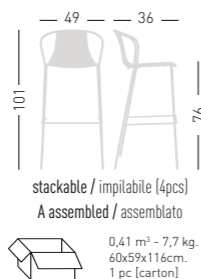

0,41 m³ - 7,7 kg.
60x59x116cm.
1 pc [carton]

Frame Finishing & Codes / Finiture Telai e Codici

cod. 189. __/IK76A__
cod. 189. __/IMG76A__
cod. 189. __/IS76A__

€ 660,00
€ 660,00
€ 660,00

Min. order 4pcs
each code
Ordine min 4pz
per codice

KASIA STOOL 66 UPHOLSTERED



4-Legged metal stool, painted with special treatment for outdoor purpose, padded and upholstered shell.
Sgabello con struttura 4 gambe in metallo verniciato con trattamento per esterno, scocca imbottita e rivestita.

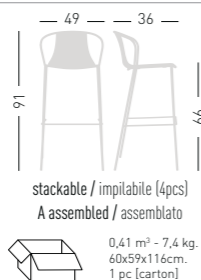

0,41 m³ - 7,4 kg.
60x59x116cm.
1 pc [carton]

Frame Finishing & Codes / Finiture Telai e Codici

cod. 189. __/IK66A__
cod. 189. __/IMG66A__
cod. 189. __/IS66A__

€ 660,00
€ 660,00
€ 660,00

Min. order 4pcs
each code
Ordine min 4pz
per codice



Available colors / Colori disponibili



LIBERTY H75



Techno-polymer seat and anodized aluminum frame.
Seduta in tecnopolimero, gambe in alluminio anodizzato.

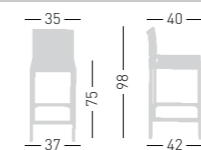

NA not assembled / non assemblato
0,13 m³ - 12,4 kg.
79x44x37cm.
2 pcs [carton]

A assembled / assemblato
0,19 m³ - 7 kg.
44x60x104cm.
1 pcs [carton]

Frame Finishing & Codes / Finiture Telai e Codici

cod.26.--/75NA not assembled/non assemblato
cod.26.--/75A assembled/assemblato

€ 240,00
€ 248,00

LIBERTY H60



Techno-polymer seat and anodized aluminum frame.
Seduta in tecnopolimero, gambe in alluminio anodizzato.

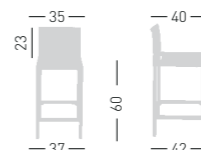

NA not assembled / non assemblato
0,13 m³ - 11,8 kg.
79x44x37cm.
2 pcs [carton]

A assembled / assemblato
0,19 m³ - 6,4 kg.
44x60x104cm.
1 pcs [carton]

Frame Finishing & Codes / Finiture Telai e Codici

cod.26.--/60NA not assembled/non assemblato
cod.26.--/60A assembled/assemblato

€ 240,00
€ 248,00

Lilà Stool



Available colors / Colori disponibili

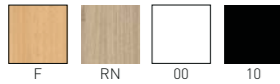

LILÀ STOOL 79

Plywood painted shell and chromed stackable frame.
Scocca in legno curvato, verniciata, telaio impilabile in metallo cromato.

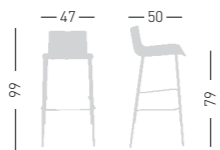

stackable / impilabile (4pcs)
NA not assembled / non assemblato



Frame Finishing & Codes / Finiture Telaie e Codici
cod.185.--/79NA chromed/cromato

€ 278,00

LILÀ STOOL 69

Plywood painted shell and chromed stackable frame.
Scocca in legno curvato, verniciata, telaio impilabile in metallo cromato.

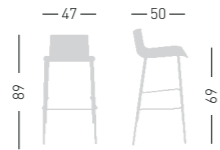

stackable / impilabile (4pcs)
NA not assembled / non assemblato

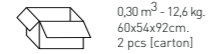

Frame Finishing & Codes / Finiture Telaie e Codici
cod.185.--/69NA chromed/cromato

€ 278,00

LILÀ STOOL UPHOLSTERED IMBOTTITI

Available coverings / Finiture disponibili
Regenerated leather / Pelle rigenerata **PR** (4pcs min.)

LILÀ STOOL 79 UPHOLSTERED

Coated shell in regenerated leather, chromed frame.
Scocca rivestita in pelle rigenerata e telaio in metallo cromato.



NA not assembled / non assemblato



Frame Finishing & Codes / Finiture Telaie e Codici

cod. 185.--/IPR79NA chromed/cromato

€ 526,00

Min. order 4pcs
each code
Ordine min 4pz
per codice

LILÀ STOOL 69 UPHOLSTERED

Coated shell in regenerated leather, chromed frame.
Scocca rivestita in pelle rigenerata e telaio in metallo cromato.

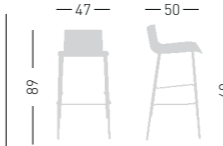

NA not assembled / non assemblato



Frame Finishing & Codes / Finiture Telaie e Codici

cod. 185.--/IPR69NA chromed/cromato

€ 526,00

Min. order 4pcs
each code
Ordine min 4pz
per codice



Link

Available colors / Colori disponibili

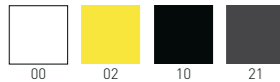

LINK



Metal frame stackable stool painted for outdoor. Sgabello impilabile con struttura in metallo verniciato per esterno.

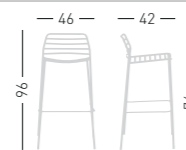

A assembled / assemblato



0,43 m³ - 23 kg.
60x61x118cm.
2 pcs [carton]

Frame Finishing & Codes / Finiture Telai e Codici

cod.90.-- /A

Paintend with special treatment for outdoor
Verniciato con trattamento per esterno

€ **484,00**

LINK STOOL CUSHION / CUSCINO



Cushion with removable cover, suitable for outdoor purpose; high density bielastic rubber padding, stitching made with raised edge. The cushion is fixed to the stool by Velcro straps.

Cuscino sfoderabile, adatto ad uso per esterni; imbottiture in gomma bielastica ad alta densità, cucitura realizzata con bordino in rilievo riportato. Il cuscino si fissa allo sgabello per mezzo di fascette in Velcro.



0,39 kg.
Inside chairs boxes
Nella scatola delle sedie.

Frame Finishing & Codes / Finiture Telai e Codici

cod.337.-- (MG)

cod.337.-- (SX)

€ **136,00**

€ **136,00**

Min. order 4pcs
each code
Ordine min 4pz
per codice

Available fabric / Tessuti disponibili
Maglia fabric / Tessuto Maglia **MG**
Silvertex Fabric / Tessuto Silvertex **SX**

Manaa Stool

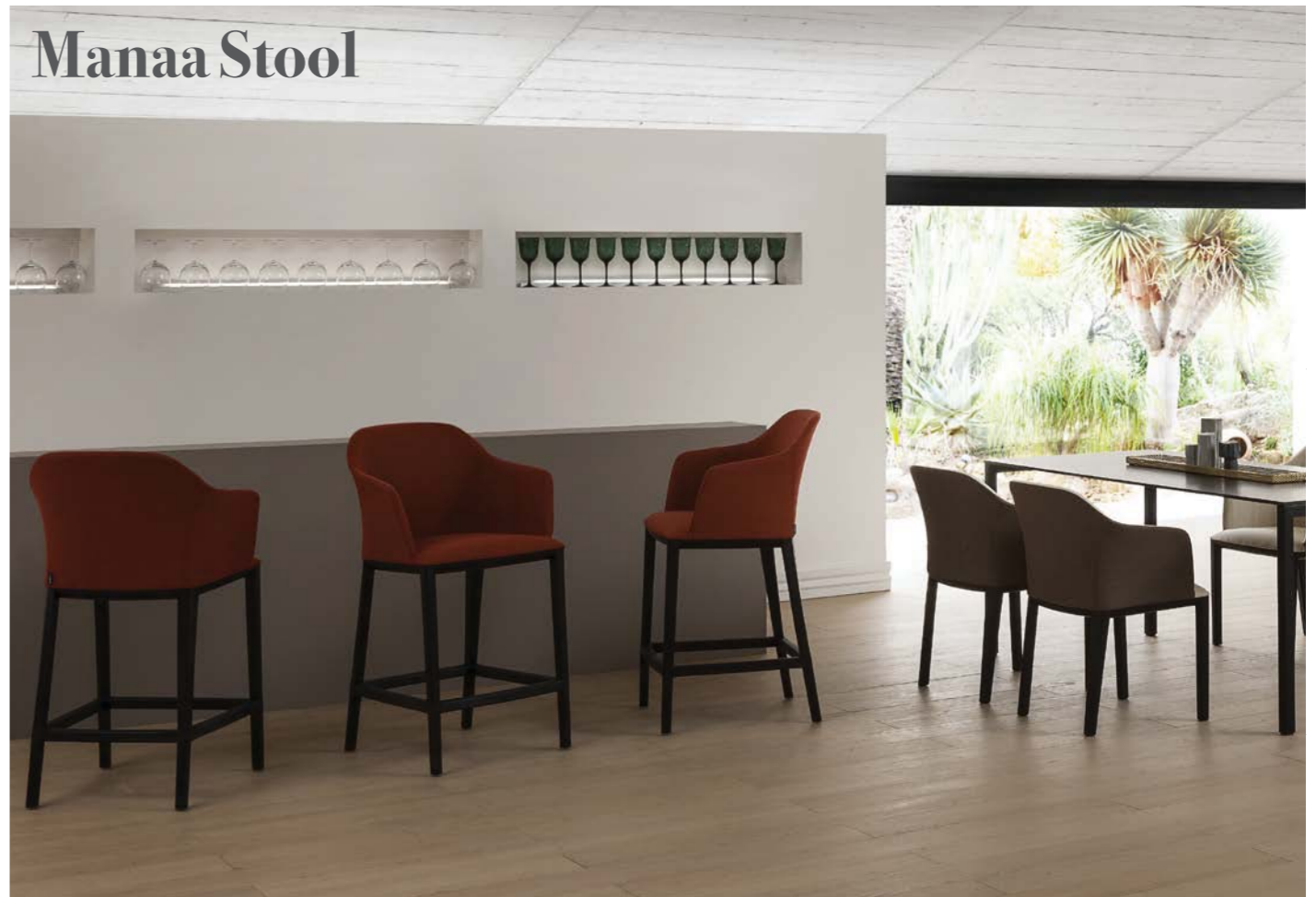

Products follows UNI 9175 -UNI 9175/FA, in terms of Fire Resistance, Fire Reation Class 11M
Prodotto Omologato dal Ministero dell'Interno, secondo la UNI 9175 -UNI 9175/FA, con classe di Reazione al fuoco 11M



Available coverings / Finiture disponibili
King fabric / Tessuto King **K** (4pcs min.)
Blazer fabric / Tessuto Blazer **B** (4pcs min.)
Superb Trevira Velvet / Velluto Superb Trevira **S** (4pcs min.)
Leather / Pelle **P** (4pcs min.)
Aurea eco-leather / Ecopelle Aurea **E** (4pcs min.)
Kvadrat fabrics / Tessuti Kvadrat **DK** (4pcs min.)
COM fabric / Tessuto cliente **TC** (10pcs min.)

Frame / Telaio



MANAA 79



Upholstered barstool, techno-polymer base. Sgabello rivestito, telaio in tecnopolimero.

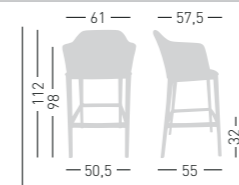

NA not assembled / non assemblato



0,29 m³ - 12,7 kg.
59,5x53,5x91,5cm.
1 pcs [carton]

Frame Finishing & Codes / Finiture Telai e Codici

cod.256.--/IK79TP--

cod.256.--/IB79TP--

cod.256.--/IS79TP--

cod.256.--/IP79TP--

cod.256.--/IE79TP--

cod.256.--/IDK79TP--

cod.256.--/IITC79TP--

€ **944,00**

€ **1.056,00**

€ **1.056,00**

€ **1.162,00**

€ **944,00**

€ **1.162,00**

€ **894,00**

Twin color upholstery details available on request
Dettagli tappezzeria bi-colore disponibili su richiesta

Fabric required
Fabbisogno di tessuto
1 pcs: Lin Mtrs 1 (h1,40)

COM fabric min. order
10pcs each code
Tessuto cliente TC ordine
min. 10pz per codice

Min. order 4pcs
each code
Ordine min 4pz
per codice

MANAA 69



Upholstered barstool, techno-polymer base. Sgabello rivestito, telaio in tecnopolimero.

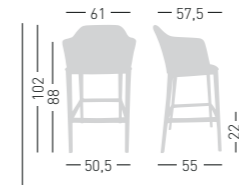

NA not assembled / non assemblato



0,29 m³ - 12,5 kg.
59,5x53,5x91,5cm.
1 pcs [carton]

Frame Finishing & Codes / Finiture Telai e Codici

cod.256.--/IK69TP--

cod.256.--/IB69TP--

cod.256.--/IS69TP--

cod.256.--/IP69TP--

cod.256.--/IE69TP--

cod.256.--/IDK69TP--

cod.256.--/IITC69TP--

€ **944,00**

€ **1.056,00**

€ **1.056,00**

€ **1.162,00**

€ **944,00**

€ **1.162,00**

€ **894,00**

Twin color upholstery details available on request
Dettagli tappezzeria bi-colore disponibili su richiesta

Fabric required
Fabbisogno di tessuto
1 pcs: Lin Mtrs 1 (h1,40)

COM fabric min. order
10pcs each code
Tessuto cliente TC ordine
min. 10pz per codice

Min. order 4pcs
each code
Ordine min 4pz
per codice

Manaa Slim



Frame / Telaio

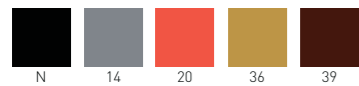

Products follows UNI 9175 -UNI 9175/FA, in terms of Fire Resistance, Fire Reation Class 11M
Prodotto Omologato dal Ministero dell'Interno, secondo la UNI 9175 -UNI 9175/FA, con classe di Reazione al fuoco 11M



Available coverings / Finiture disponibili
King fabric / Tessuto King **K** (4pcs min.)
Blazer fabric / Tessuto Blazer **B** (4pcs min.)
Superb Trevira Velvet / Velluto Superb Trevira **S** (4pcs min.)
Leather / Pelle **P** (4pcs min.)
Aurea eco-leather / Ecopelle Aurea **E** (4pcs min.)
Kvadrat fabrics / Tessuti Kvadrat **DK** (4pcs min.)
COM fabric / Tessuto cliente **TC** (10pcs min.)

MANAA SLIM 79

Upholstered barstool, techno-polymer base. Sgabelllo rivestito, telaio in tecnopolimero.

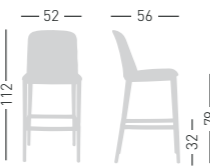

NA not assembled / non assemblato



0,29 m³ - 12,2 kg.
59,5x53,5x91,5cm.
1 pcs [carton]

Frame Finishing & Codes / Finiture Telaio e Codici

cod.254.--/IK79TP--	€ 872,00
cod.254.--/IE79TP--	€ 872,00
cod.254.--/IB79TP--	€ 984,00
cod.254.--/IS79TP--	€ 984,00
cod.254.--/IP79TP--	€ 1.090,00
cod.254.--/IDK79TP--	€ 1.090,00
cod.254./ITC79TP--	€ 820,00

Twin color upholstery details available on request
Dettagli tappezzeria bi-colore disponibili su richiesta

Fabric required
Fabbisogno di tessuto
1 pcs: Lin Mtrs 1 (h1,40)

COM fabric min. order
10pcs each code
Tessuto cliente TC ordine
min. 10pz per codice

Min. order 4pcs
each code
Ordine min 4pz
per codice

MANAA SLIM 69

Upholstered barstool, techno-polymer base. Sgabelllo rivestito, telaio in tecnopolimero.

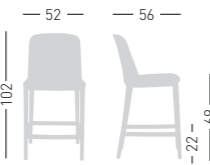

NA not assembled / non assemblato



0,29 m³ - 12 kg.
59,5x53,5x91,5cm.
1 pcs [carton]

Frame Finishing & Codes / Finiture Telaio e Codici

cod.254.--/IK69TP--	€ 872,00
cod.254.--/IE69TP--	€ 872,00
cod.254.--/IB69TP--	€ 984,00
cod.254.--/IS69TP--	€ 984,00
cod.254.--/IP69TP--	€ 1.090,00
cod.254.--/IDK69TP--	€ 1.090,00
cod.254./ITC69TP--	€ 820,00

Twin color upholstery details available on request
Dettagli tappezzeria bi-colore disponibili su richiesta

Fabric required
Fabbisogno di tessuto
1 pcs: Lin Mtrs 1 (h1,40)

COM fabric min. order
10pcs each code
Tessuto cliente TC ordine
min. 10pz per codice

Min. order 4pcs
each code
Ordine min 4pz
per codice

Max



Available colors / Colori disponibili



MAX H42

Techno-polymer seat and anodized aluminum frame. Seduta in tecnopolimero, gambe in alluminio anodizzato.

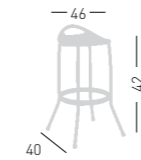

NA not assembled / non assemblato



0,06 m³ - 7,6 kg.
16x78x41,5cm.
2 pcs [carton]

Frame Finishing & Codes / Finiture Telaio e Codici

cod.16.--/42NA

€ 162,00

MAX H60

Techno-polymer seat and anodized aluminum frame. Seduta in tecnopolimero, gambe in alluminio anodizzato.

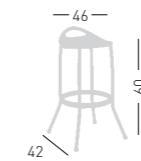

NA not assembled / non assemblato



0,06 m³ - 7,8 kg.
16x78x41,5cm.
2 pcs [carton]

Frame Finishing & Codes / Finiture Telaio e Codici

cod.16.--/60NA

€ 162,00

MAX H75

Techno-polymer seat and anodized aluminum frame. Seduta in tecnopolimero, gambe in alluminio anodizzato.

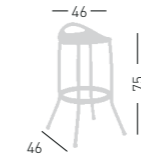

NA not assembled / non assemblato



0,06 m³ - 9 kg.
16x78x41,5cm.
2 pcs [carton]

Frame Finishing & Codes / Finiture Telaio e Codici

cod.16.--/75NA

€ 162,00



Available colors / Colori disponibili

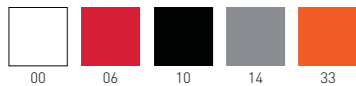

MICRO A



Techno-polymer seat, chromed frame and combined base. Seduta in tecnopolimero, telaio cromato e base abbinata.

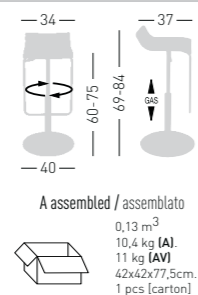

Frame Finishing & Codes / Finiture Telai e Codici

cod. 59.-- /A

Base color combined with the seat
Colore base abbinata alla seduta

cod. 59.-- /AV

chromed base/base cromata

€ **346,00**

€ **404,00**

A assembled / assemblato
0,13 m³
10,4 kg (A)
11 kg (AV)
42x42x77,5cm.
1 pcs [carton]

MICRO X



Techno-polymer seat, chromed frame and base. Seduta in tecnopolimero, telaio e base cromati.

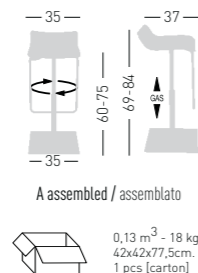

Frame Finishing & Codes / Finiture Telai e Codici

cod. 59.-- /X chromed base/base cromata

€ **484,00**

A assembled / assemblato
0,13 m³ - 18 kg.
42x42x77,5cm.
1 pcs [carton]



Available colors / Colori disponibili



MOEMA



Techno-polymer seat, chromed frame and base. Seduta in tecnopolimero, telaio cromato e base cromata.

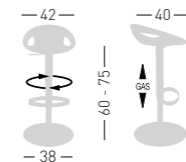

A assembled / assemblato

0,19 m³ - 9,5 kg.
46x46x89cm
1 pcs [carton]

Frame Finishing & Codes / Finiture Telai e Codici

cod. 74.-- /A
chromed base/base cromata

€ **396,00**

MOEMA UPHOLSTERED IMBOTTITI

Available coverings / Finiture disponibili
Leather / Pelle **P** (4pcs min.)

MOEMA UPHOLSTERED



Techno-polymer seat upholstered in leather, anodized aluminum frame. Seduta in tecnopolimero rivestito in pelle, telaio cromato e base cromata.

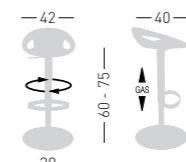

A assembled / assemblato

0,19 m³ - 10 kg.
46x46x89cm
1 pcs [carton]

Frame Finishing & Codes / Finiture Telai e Codici

cod. 74.-- /IPA

€ **840,00**

Min. order 4pcs
each code
Ordine min 4pz
per codice

MOEMA STOOL 75

Chromed or painted 4-Legged metal frame; techno-polymer shell.
Struttura in metallo 4 gambe, cromata o verniciata; scocca in tecnopolimero.

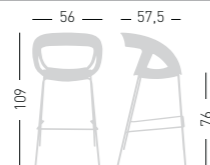

NA not assembled / non assemblata

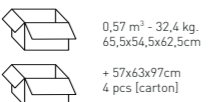

only for painted frames
solo per telai verniciati

Frame Finishing & Codes / Finiture Telai e Codici

cod. 70__/75NA chromed/cromata
cod. 70__/75NAN black painted/verniciato nero
cod. 70__/75NAB white painted/verniciato bianco

€ 268,00
€ 304,00
€ 304,00

Available Shell Colors / Colori disponibili Scocca

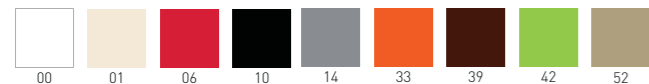

MOEMA CUSHION / CUSCINO

Upholstered cushion.
Cuscino tappezzato.



0,6 kg.
Inside chairs boxes
Inseriti nella
scatola delle sedie

Frame Finishing & Codes / Finiture Telai e Codici

cod.310.--
cod.310.-- (B)
cod.310.TC COM fabric/tessuto cliente

€ 112,00
€ 128,00
€ 100,00

Fabric required
Fabbisogno di tessuto
4 pcs: Lin Mtrs 1,0 (h1,40)

COM fabric min. order
10pcs each code
Tessuto cliente TC ordine
min. 10pz per codice

Min. order 4pcs
each code
Ordine min 4pz
per codice

MOEMA UPHOLSTERED IMBOTTITI

Available coverings / Finiture disponibili
Leather / Pelle **P** (4pcs min.)
King fabric / Tessuto King **K** (4pcs min.)
Aurea eco-leather / Ecopelle aurea **E** (4pcs min.)
COM fabric / Tessuto cliente **TC** (10pcs min.)

MOEMA STOOL 78 UPHOLSTERED

Chromed or Painted 4-legged metal frame, padded and upholstered shell.
Sgabello con seduta imbottita e rivestita, telaio 4 gambe in metallo cromato o verniciato.

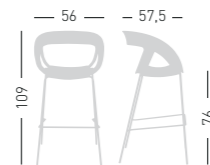

NA not assembled / non assemblata

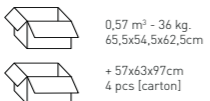

Frame Finishing & Codes / Finiture Telai e Codici

cod. 70__/IP78NA chromed/cromata
cod. 70__/IP78NAN black painted/verniciato nero
cod. 70__/IP78NAB white painted/verniciato bianco
cod. 70__/IK78NA chromed/cromata
cod. 70__/IK78NAN black painted/verniciato nero
cod. 70__/IK78NAB white painted/verniciato bianco
cod. 70__/IE78NA chromed/cromata
cod. 70__/IE78NAN black painted/verniciato nero
cod. 70__/IE78NAB white painted/verniciato bianco
cod. 70__/ITC78NA chromed/cromata
cod. 70__/ITC78NAN black painted/verniciato nero
cod. 70__/ITC78NAB white painted/verniciato bianco

€ 706,00
€ 730,00
€ 730,00
€ 658,00
€ 682,00
€ 682,00
€ 658,00
€ 682,00
€ 682,00
€ 630,00
€ 656,00
€ 656,00

Fabric required
Fabbisogno di tessuto
1 pcs: Lin Mtrs 1,5 (h1,40)

COM fabric min. order
10pcs each code
Tessuto cliente TC ordine
min. 10pz per codice

Min. order 4pcs
each code
Ordine min 4pz
per codice

More



Available colors / Colori disponibili



MORE ST 76



Techno-polymer seat, chromed or outdoor painted frame.
Sgabello con seduta in tecnopolimero e telaio in metallo cromato o verniciato per esterno.



only for painted frames
solo per telai verniciati



NA not assembled / non assemblato

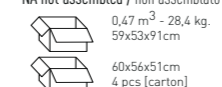

Frame Finishing & Codes / Finiture Telai e Codici

cod.171.--/76ST chromed/cromata
cod.171.--/76STB white/bianco
cod.171.--/76STN black/nero

€ 256,00
€ 306,00
€ 306,00

MORE ST 66



Techno-polymer seat, chromed or outdoor painted frame.
Sgabello con seduta in tecnopolimero e telaio in metallo cromato o verniciato per esterno.



only for painted frames
solo per telai verniciati

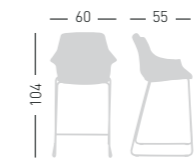

NA not assembled / non assemblato

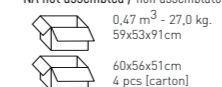

Frame Finishing & Codes / Finiture Telai e Codici

cod.171.--/66ST chromed/cromata
cod.171.--/66STB white/bianco
cod.171.--/66STN black/nero

€ 256,00
€ 306,00
€ 306,00

MORE UPHOLSTERED IMBOTTITI

Products follows UNI 9175 -UNI 9175/FA, in terms of Fire Resistance, Fire Reation Class 11M
Prodotto Omologato dal Ministero dell'Interno, secondo la UNI 9175 -UNI 9175/FA, con classe di Reazione al fuoco 11M



Available coverings / Finiture disponibili
Aurea eco-leather / Ecopelle Aurea **E** (4pcs min.)
King fabric / Tessuto King **K** (4pcs min.)
Kvadrat fabrics / Tessuti Kvadrat **DK** (4pcs min.)
COM fabric / Tessuto cliente **TC** (10pcs min.)

MORE ST 76 UPHOLSTERED



Upholstered techno-polymer seat and chromed or outdoor painted frame.
Sgabello con seduta in tecnopolimero e telaio in metallo cromato o verniciato per esterno.

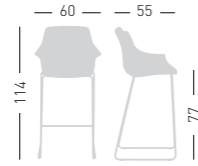

NA not assembled / non assemblato

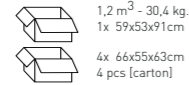

Frame Finishing & Codes / Finiture Telai e Codici

cod.171.--/IE76ST chromed/cromata	€ 878,00
cod.171.--/IE76STB white/bianco	€ 928,00
cod.171.--/IE76STN black/nero	€ 928,00
cod.171.--/IK76ST chromed/cromata	€ 878,00
cod.171.--/IK76STB white/bianco	€ 928,00
cod.171.--/IK76STN black/nero	€ 928,00
cod.171.--/IDK76ST chromed/cromata	€ 1.058,00
cod.171.--/IDK76STB white/bianco	€ 1.108,00
cod.171.--/IDK76STN black/nero	€ 1.108,00
cod.171/ITC76ST chromed/cromata	€ 814,00
cod.171/ITC76STB white/bianco	€ 864,00
cod.171/ITC76STN black/nero	€ 864,00

Fabric required
Fabbisogno di tessuto
1 pcs: Lin Mtrs 1,3 (h1,40)

COM fabric min. order
10pcs each code
Tessuto cliente TC ordine
min. 10pz per codice

Min. order 4pcs
each code
Ordine min 4pz
per codice

MORE ST 66 UPHOLSTERED



Upholstered techno-polymer seat and chromed or outdoor painted frame.
Sgabello con seduta in tecnopolimero e telaio in metallo cromato o verniciato per esterno.

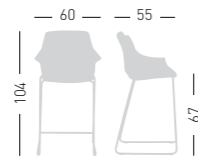

NA not assembled / non assemblato

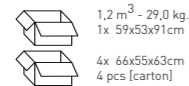

Frame Finishing & Codes / Finiture Telai e Codici

cod.171.--/IE66ST chromed/cromata	€ 878,00
cod.171.--/IE66STB white/bianco	€ 928,00
cod.171.--/IE66STN black/nero	€ 928,00
cod.171.--/IK66ST chromed/cromata	€ 878,00
cod.171.--/IK66STB white/bianco	€ 928,00
cod.171.--/IK66STN black/nero	€ 928,00
cod.171.--/IDK66ST chromed/cromata	€ 1.058,00
cod.171.--/IDK66STB white/bianco	€ 1.108,00
cod.171.--/IDK66STN black/nero	€ 1.108,00
cod.171/ITC66ST chromed/cromata	€ 814,00
cod.171/ITC66STB white/bianco	€ 864,00
cod.171/ITC66STN black/nero	€ 864,00

Fabric required
Fabbisogno di tessuto
1 pcs: Lin Mtrs 1,3 (h1,40)

COM fabric min. order
10pcs each code
Tessuto cliente TC ordine
min. 10pz per codice

Min. order 4pcs
each code
Ordine min 4pz
per codice



Available Color / Colori disponibili

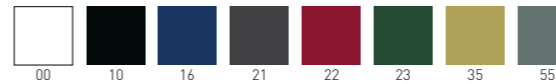

NUTA STOOL 78



Stackable techno-polymer stool.
Sgabello impilabile in tecnopolimero.

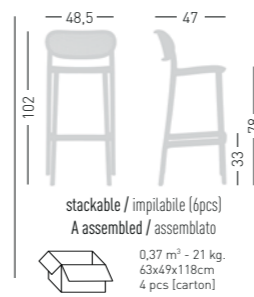

stackable / impilabile (6pcs)

A assembled / assemblato



Frame Finishing & Codes / Finiture Telai e Codici

cod. 356.____/78A

€ 192,00

NUTA STOOL 68



Stackable techno-polymer stool.
Sgabello impilabile in tecnopolimero.

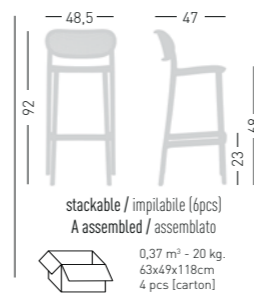

stackable / impilabile (6pcs)

A assembled / assemblato



Frame Finishing & Codes / Finiture Telai e Codici

cod. 356.____/68A

€ 192,00

NUTA STOOL CUSHION / CUSCINO

Stool upholstered cushion.
Cuscino tappezzato.

Available fabric.
Tessuti disponibili.
K, B, E, DK, TC



2 kg.
Inside chairs
boxes
Nella scatola
delle sedie:
4 pcs [carton]

Frame Finishing & Codes / Finiture Telai e Codici

cod.335.-- (K)	€	102,00
cod.335.-- (E)	€	102,00
cod.335.-- (B)	€	110,00
cod.335.-- (DK)	€	126,00
cod.335.TC COM fabric/tessuto cliente	€	88,00

Minimum order 4pcs each code
Ordine minimo 4 pezzi per codice

COM fabric minimum order 10pcs each code
Tessuto cliente TC ordine minimo 10pz per codice

Fabric required / Fabbisogno di tessuto
1 pcs : Lin Mtrs 0,5 (h1,40)

Nuta Light Stool



Available frame colors / Colori disponibili telaio

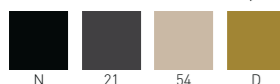

NUTA LIGHT STOOL 77

Metal frame, padded and upholstered
seat and back. Stackable stool.
Struttura in metallo a sostegno di
sedile e schienale, imbottiti e rivestiti.
Sgabello impilabile.



50 52
101 77



stackable / impilabile (2pcs)
A assembled / assemblato
0,41 m³ - 7,7 kg.
60x59x116cm
1 pc [carton]

Frame Finishing & Codes / Finiture Telai e Codici

cod. 359.--/IK77A_	€	672,00
cod. 359.--/IM677A_	€	672,00
cod. 359.--/IS77A_	€	672,00

Min. order 4pcs
each code
Ordine min 4pz
per codice

Available coverings / Finiture disponibili
King fabric / Tessuto King **K** (4pcs min.)
Maglia fabric / Tessuto Maglia **MG** (4pcs min.)
Superb Trevira Velvet / Velluto Superb Trevira **S** (4pcs min.)

NUTA LIGHT STOOL 67



Metal frame, padded and upholstered
seat and back. Stackable stool.
Struttura in metallo a sostegno di
sedile e schienale, imbottiti e rivestiti.
Sgabello impilabile.

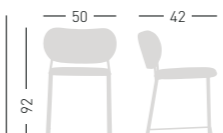

stackable / impilabile (2pcs)
A assembled / assemblato



0,41 m³ - 7,2 kg.
60x59x116cm
1 pc [carton]

Frame Finishing & Codes / Finiture Telai e Codici

cod. 359.--/IK67A_	€	672,00
cod. 359.--/IM67A_	€	672,00
cod. 359.--/IS67A_	€	672,00

Min. order 4pcs
each code
Ordine min 4pz
per codice



Available colors / Colori disponibili

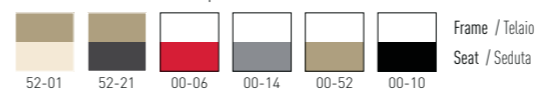

OCTO

Seat and frame in techno-polymer,
swivel chromed or satin base.
Seduta e telaio in tecnopolimero,
basamento girevole cromato o satinato.

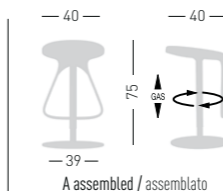

A assembled / assemblato

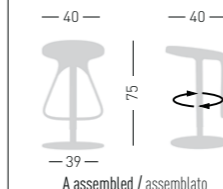

A assembled / assemblato



0,12 m³ - 16 kg.
43,5x45x60cm
1 pcs [carton]

Frame Finishing & Codes / Finiture Telai e Codici
chromed frame/telaio cromato
cod. 146.--/A
swivel and adjustable stool
girevole + alzata gas

€ **598,00**

satin frame/telaio satinato
cod. 146.--/AS
swivel and adjustable stool
girevole + alzata gas

€ **718,00**



0,19 m³ - 15,5 kg.
46x46x89cm
1 pcs [carton]

chromed frame/telaio cromato
cod. 147.--/A
swivel stool
solo girevole

€ **598,00**

satin frame/telaio satinato
cod. 147.--/AS
swivel stool
solo girevole

€ **718,00**



Available colors / Colori disponibili

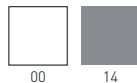

OFER H60



Techno-polymer seat and anodized aluminum frame. Seduta in tecnopolimero, gambe in alluminio anodizzato.



NA not assembled / non assemblato



Frame Finishing & Codes / Finiture Telai e Codici

cod.37.--/60NA

€ 222,00

OFER H75



Techno-polymer seat and anodized aluminum frame. Seduta in tecnopolimero, gambe in alluminio anodizzato.



NA not assembled / non assemblato



Frame Finishing & Codes / Finiture Telai e Codici

cod.37.--/75NA

€ 222,00



Available colors / Colori disponibili



OVER



Techno-polymer seat, chromed frame and combined base. Seduta in tecnopolimero, telaio cromato e base abbinata.

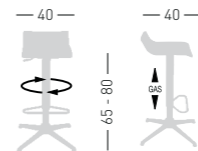

A assembled / assemblato



Frame Finishing & Codes / Finiture Telai e Codici

cod. 39.-- /A

€ 282,00

Base color combined with the seat
Colore base abbinata alla seduta

OVER T



Techno-polymer seat, chromed frame and combined base. Seduta in tecnopolimero, telaio cromato e base abbinata.

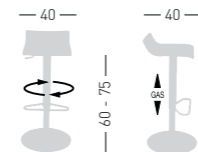

A assembled / assemblato



Frame Finishing & Codes / Finiture Telai e Codici

cod. 39.-- /T

€ 314,00

Base color combined with the seat
Colore base abbinata alla seduta

OVER TV



Techno-polymer seat, chromed frame and base. Seduta in tecnopolimero, telaio cromato e base cromata.

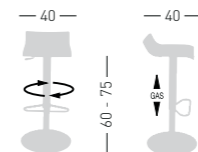

A assembled / assemblato



Frame Finishing & Codes / Finiture Telai e Codici

cod. 39.-- /TV chromed base/base cromata

€ 368,00



Available colors / Colori disponibili



PANAMA



Techno-polymer shell and painted metal frame.
Scocca in tecnopolimero e struttura in metallo verniciato.

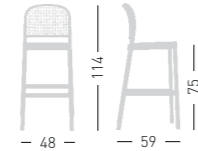

A assembled / assemblato



Frame Finishing & Codes / Finiture Telai e Codici

cod. 242.-- /A

€ 358,00

PANAMA B



Techno-polymer shell with armrests and painted metal frame.
Scocca in tecnopolimero con braccioli e struttura in metallo verniciato.



A assembled / assemblato



Frame Finishing & Codes / Finiture Telai e Codici

cod. 243.-- /A

€ 448,00

PANAMA BL



Techno-polymer shell and beech wooden frame.
Scocca in tecnopolimero e struttura in legno di faggio.



A assembled / assemblato



Frame Finishing & Codes / Finiture Telai e Codici

cod.242.--/BL_

€ 396,00

Felt Glides / Tappi in feltro

PANAMA BLB



Techno-polymer shell with armrests and beech wooden frame.
Scocca in tecnopolimero con braccioli e struttura in legno di faggio.

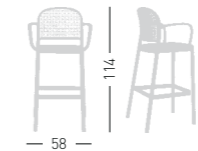

A assembled / assemblato



Frame Finishing & Codes / Finiture Telai e Codici

cod.243.--/BL_

€ 484,00

Felt Glides / Tappi in feltro

PANAMA CUSHION CUSCINO



Upholstered cushion.
Cuscino tappezzato.

Available fabric.
Tessuti disponibili.
E, K
COM fabric / Tessuto cliente TC (10pcs min.)



Frame Finishing & Codes / Finiture Telai e Codici

cod.303.---- seat/sedile

€ 136,00

It is possible to order the seat cushion only if coupled to the chair.
Cuscino sedile ordinabile solo se accoppiato alla sedia

Fabric required
Fabbisogno di tessuto
4 pcs: Lin Mtrs 1,0 (h1,40)

COM fabric min. order 10pcs each code
Tessuto cliente TC ordine min. 10pz per codice

Min. order 4pcs each code
Ordine min 4pz per codice



Available colors / Colori disponibili

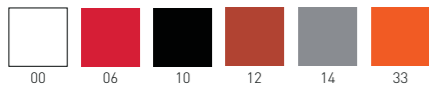

PRODIGE 77



Techno-polymer shell, chromed or outdoor painted frame. Seduta in tecnopolimero, telaio cromato o verniciato per esterno.



only for paintend frames
solo per telai verniciati

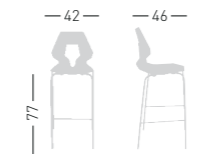

NA not assembled / non assemblato

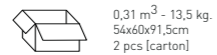

0,31 m³ - 13,5 kg.
54x60x91,5cm
2 pcs [carton]

Frame Finishing & Codes / Finiture Telai e Codici

cod. 63.-- /77 NA chromed/cromata
cod. 63.-- /77 NAB white painted/verniciato bianco
cod. 63.-- /77 NAN black painted/verniciato nero

€ 212,00
€ 242,00
€ 242,00

PRODIGE 67



Techno-polymer shell, chromed or outdoor painted frame. Seduta in tecnopolimero, telaio cromato o verniciato per esterno.



only for paintend frames
solo per telai verniciati

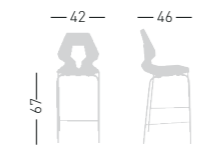

NA not assembled / non assemblato



0,31 m³ - 12,6 kg.
54x60x91,5cm
2 pcs [carton]

Frame Finishing & Codes / Finiture Telai e Codici

cod. 63.-- /67 NA chromed/cromata
cod. 63.-- /67 NAB white painted/verniciato bianco
cod. 63.-- /67 NAN black painted/verniciato nero

€ 212,00
€ 242,00
€ 242,00

RITMO



Swivel and height adjustable pivoting stool "Ritmo". Black structure with chromed gas lift. Sgabello girevole, orientabile e regolabile in altezza "Ritmo". Struttura nera con alzata gas cromata

Available fabric.
Tessuti disponibili.
K, E, B, DK, TC

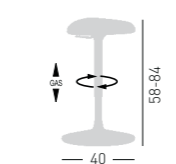

A assembled / assemblato



0,13 m³ - 7 kg.
42x42x77cm.
1 pcs [carton]

Frame Finishing & Codes / Finiture Telai e Codici

cod. 73._/IKA
cod. 73._/IEA
cod. 73._/IBA
cod. 73._/IDKA
cod. 73/ITCA COM fabric/tessuto cliente

€ 644,00
€ 644,00
€ 660,00
€ 678,00
€ 606,00

Fabric required
Fabbisogno di tessuto
2 pcs: Lin Mtrs 0,8 (h1,40)

COM fabric min. order
10pcs each code
Tessuto cliente TC ordine
min. 10pz per codice

Min. order 4pcs
each code
Ordine min 4pz
per codice



Available colors / Colori disponibili

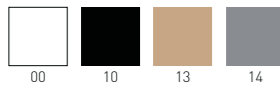

ROLLER

Techno-polymer stool.
Sgabello in tecnopolimero.

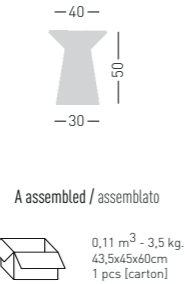

A assembled / assemblato

0,11 m³ - 3,5 kg.
43,5x45x60cm
1 pcs [carton]

Frame Finishing & Codes / Finiture Tetai e Codici

cod. 244.-- / A

€ 222,00

ROLLER 75

Techno-polymer stool.
Sgabello in tecnopolimero.

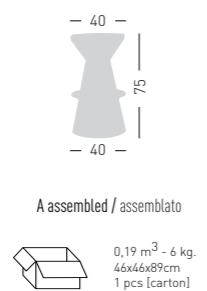

A assembled / assemblato

0,19 m³ - 6 kg.
46x46x89cm
1 pcs [carton]

Frame Finishing & Codes / Finiture Tetai e Codici

cod. 245.--/A

€ 276,00

Sanela Stool



Available rope color / Colori disponibili corda

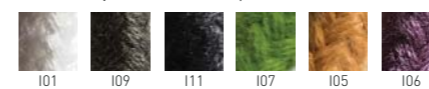

Available colors / Colori disponibili

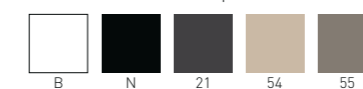

SANELA STOOL 75

4-Legged metal stool, painted with special treatment for outdoor purpose, with wrapped rope.
Sgabello con struttura 4 gambe in metallo verniciato con trattamento per esterno, con intreccio artigianale di corda.

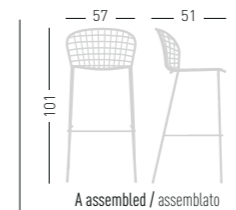

A assembled / assemblato

0,41 m³ - 7,5 kg.
60x59x116cm.
1 pc [carton]

Frame Finishing & Codes / Finiture Tetai e Codici

cod. 274._(11)/75A_

€ 902,00

Min. order 20pcs
each code
Ordine min 20pz
per codice



Available colors / Colori disponibili

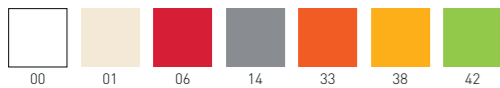

SHIVER



Stackable techno-polymer stool.
Sgabello impilabile in tecnopolimero.



stackable / impilabile (4pcs)
A assembled / assemblato



0,35 m³ - 19 kg.
62,5x46x97cm.
4 pcs [carton]

Frame Finishing & Codes / Finiture Telai e Codici

cod.68.--/A

€ 174,00



Available colors / Colori disponibili

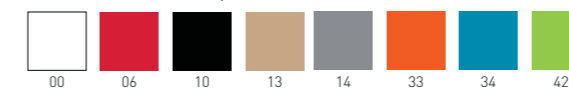

SLOT FILL 78



Stackable techno-polymer stool,
chromed or outdoor painted frame.
Sgabello impilabile con seduta in
tecnopolimero e telaio in metallo
cromato o verniciato per esterno.



stackable / impilabile (4pcs)
NA not assembled / non assemblato



0,41 m³ - 24 kg.
59x53x91cm
49x49x48cm
4 pcs [carton]

Frame Finishing & Codes / Finiture Telai e Codici

cod.259.--/78NA chromed/cromata
cod.259.--/78NAB white/bianco

€ 240,00
€ 270,00

SLOT FILL 68



Stackable techno-polymer stool,
chromed or outdoor painted frame.
Sgabello impilabile con seduta in
tecnopolimero e telaio in metallo
cromato o verniciato per esterno.

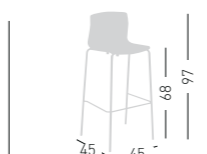

stackable / impilabile (4pcs)
NA not assembled / non assemblato

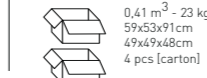

0,41 m³ - 23 kg.
59x53x91cm
49x49x48cm
4 pcs [carton]

Frame Finishing & Codes / Finiture Telai e Codici

cod.259.--/68NA chromed/cromata
cod.259.--/68NAB white/bianco

€ 240,00
€ 270,00

SLOT FILL 78 BL Techno-polymer seat, wooden beech frame. Seduta in tecnopolimero, telaio in legno di faggio.



Price + € 20,00

F RN

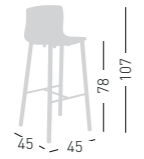

NA not assembled / non assemblato

0,19 m³ - 13,2 kg.
46x46x89cm.
2 pcs (carton)

Frame Finishing & Codes / Finiture Telai e Codici
cod.259.--/78BL_

Felt Glides / Tappi in feltro

€ 476,00

SLOT FILL 68 BL Techno-polymer seat, wooden beech frame. Seduta in tecnopolimero, telaio in legno di faggio.



Price + € 20,00

F RN



NA not assembled / non assemblato

0,19 m³ - 13 kg.
46x46x89cm.
2 pcs (carton)

Frame Finishing & Codes / Finiture Telai e Codici
cod.259.--/68BL_

Felt Glides / Tappi in feltro

€ 476,00

SLOT FILL AV Techno-polymer seat, chromed frame and base. Seduta in tecnopolimero, telaio e base cromata.



Price + € 20,00

F RN

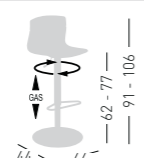

A assembled / assemblato

0,19 m³ - 12,0 kg.
46x46x89cm.
1 pcs (carton)

Frame Finishing & Codes / Finiture Telai e Codici
cod.259.--/AV chromed/cromata

€ 388,00

SLOT FILL AFV Techno-polymer seat, chromed frame and base. Seduta in tecnopolimero, telaio e base cromata.



Price + € 20,00

F RN

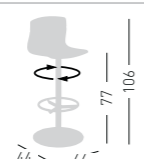

NA not assembled / non assemblato

0,13 m³ - 12,0 kg.
42x42x77,5cm.
1 pcs (carton)

Frame Finishing & Codes / Finiture Telai e Codici
cod.259.--/AFV chromed/cromata

€ 360,00

SLOT UPHOLSTERED IMBOTTITI

SLOT 78 UPHOLSTERED Fabric or leather upholstered seat, chromed or painted frame. Sgabello imbottito in tessuto o pelle e telaio in metallo cromato o verniciato.



Price + € 20,00

F RN

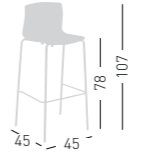

NA not assembled / non assemblato

0,41 m³ - 26 kg.
50x50x49cm.
60x54x92cm.
4 pcs (carton)

Frame Finishing & Codes / Finiture Telai e Codici

cod.258.--/IE78NA chromed/cromata	€ 526,00
cod.258.--/IE78NAB white/bianco	€ 558,00
cod.258.--/IK78NA chromed/cromata	€ 526,00
cod.258.--/IK78NAB white/bianco	€ 558,00
cod.258.--/IB78NA chromed/cromata	€ 566,00
cod.258.--/IB78NAB white/bianco	€ 602,00
cod.258.--/IDK78NA chromed/cromata	€ 662,00
cod.258.--/IDK78NAB white/bianco	€ 698,00
cod.258./ITC78NA chromed/cromata	€ 502,00
cod.258./ITC78NAB white/bianco	€ 536,00

Fabric required
Fabbisogno di tessuto
1 pcs: Lin Mtrs 0,9 (h1,40)

COM fabric min. order
10pcs each code
Tessuto cliente TC ordine min. 10pz per codice

Min. order 4pcs each code
Ordine min 4pz per codice

SLOT 68 UPHOLSTERED Fabric or leather upholstered seat, chromed or painted frame. Sgabello imbottito in tessuto o pelle e telaio in metallo cromato o verniciato.



Price + € 20,00

F RN

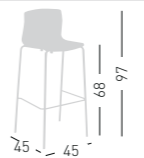

NA not assembled / non assemblato

0,41 m³ - 25 kg.
50x50x49cm.
60x54x92cm.
4 pcs (carton)

Frame Finishing & Codes / Finiture Telai e Codici

cod.258.--/IE68NA chromed/cromata	€ 526,00
cod.258.--/IE68NAB white/bianco	€ 558,00
cod.258.--/IK68NA chromed/cromata	€ 526,00
cod.258.--/IK68NAB white/bianco	€ 558,00
cod.258.--/IB68NA chromed/cromata	€ 566,00
cod.258.--/IB68NAB white/bianco	€ 602,00
cod.258.--/IDK68NA chromed/cromata	€ 662,00
cod.258.--/IDK68NAB white/bianco	€ 698,00
cod.258./ITC68NA chromed/cromata	€ 502,00
cod.258./ITC68NAB white/bianco	€ 536,00

Fabric required
Fabbisogno di tessuto
1 pcs: Lin Mtrs 0,9 (h1,40)

COM fabric min. order
10pcs each code
Tessuto cliente TC ordine min. 10pz per codice

Min. order 4pcs each code
Ordine min 4pz per codice

SLOT 78 BL UPHOLSTERED Fabric or leather upholstered seat, wooden beech frame. Sgabello imbottito in tessuto o pelle, telaio in legno di faggio.



Price + € 20,00

F RN



NA not assembled / non assemblato

0,19 m³ - 14,2 kg.
46x46x89cm.
2 pcs (carton)

Frame Finishing & Codes / Finiture Telai e Codici

cod.258.--/IE78BL_	€ 770,00
cod.258.--/IK78BL_	€ 770,00
cod.258.--/IB78BL_	€ 814,00
cod.258.--/IDK78BL_	€ 908,00
cod.258./ITC78BL_	€ 720,00

Felt Glides / Tappi in feltro

Fabric required
Fabbisogno di tessuto
1 pcs: Lin Mtrs 0,9 (h1,40)

COM fabric min. order
10pcs each code
Tessuto cliente TC ordine min. 10pz per codice

Min. order 4pcs each code
Ordine min 4pz per codice

SLOT 68 BL UPHOLSTERED Fabric or leather upholstered seat, wooden beech frame. Sgabello imbottito in tessuto o pelle, telaio in legno di faggio.



Price + € 20,00

F RN



NA not assembled / non assemblato

0,19 m³ - 14 kg.
46x46x89cm.
2 pcs (carton)

Frame Finishing & Codes / Finiture Telai e Codici

cod.258.--/IE68BL_	€ 770,00
cod.258.--/IK68BL_	€ 770,00
cod.258.--/IB68BL_	€ 814,00
cod.258.--/IDK68BL_	€ 908,00
cod.258./ITC68BL_	€ 720,00

Felt Glides / Tappi in feltro

Fabric required
Fabbisogno di tessuto
1 pcs: Lin Mtrs 0,9 (h1,40)

COM fabric min. order
10pcs each code
Tessuto cliente TC ordine min. 10pz per codice

Min. order 4pcs each code
Ordine min 4pz per codice

Available coverings / Finiture disponibili
Aurea eco-leather / Ecopelle aurea **E** (4pcs min.)
King fabric / Tessuto King **K** (4pcs min.)
Blazer fabric / Tessuto blazer **B** (4pcs min.)
Kvadrat fabrics / Tessuti Kvadrat **DK** (4pcs min.)
COM fabric / Tessuto cliente **TC** (10pcs min.)

**SLOT AV
UPHOLSTERED**



Stool upholstered in fabric or leather, chromed frame and base.
Sgabello imbottito in tessuto o pelle, telaio e base cromata.

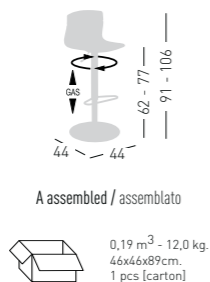

0,19 m³ - 12,0 kg.
46x46x89cm.
1 pcs [carton]

Frame Finishing & Codes / Finiture Telai e Codici

- cod.258.--/IEAV** chromed/cromata
- cod.258.--/IKAV** chromed/cromata
- cod.258.--/IBAV** chromed/cromata
- cod.258.--/IDKAV** chromed/cromata
- cod.258.--/ITCAV** chromed/cromata

- € **672,00**
- € **672,00**
- € **716,00**
- € **808,00**
- € **646,00**

COM fabric min. order 10pcs each code
Tessuto cliente TC ordine min. 10pz per codice

Min. order 4pcs each code
Ordine min 4pz per codice

**SLOT AFV
UPHOLSTERED**



Stool upholstered in fabric or leather, chromed frame and base.
Sgabello imbottito in tessuto o pelle, telaio e base cromata.

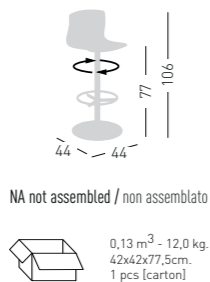

0,13 m³ - 12,0 kg.
42x42x77,5cm.
1 pcs [carton]

Frame Finishing & Codes / Finiture Telai e Codici

- cod.258.--/IEAFV** chromed/cromata
- cod.258.--/IKAFV** chromed/cromata
- cod.258.--/IBAFV** chromed/cromata
- cod.258.--/IDKAFV** chromed/cromata
- cod.258.--/ITCAFV** chromed/cromata

- € **644,00**
- € **644,00**
- € **686,00**
- € **782,00**
- € **620,00**

COM fabric min. order 10pcs each code
Tessuto cliente TC ordine min. 10pz per codice

Min. order 4pcs each code
Ordine min 4pz per codice



Available colors / Colori disponibili



SNACK



Techno-polymer seat, chromed frame and combined base.
Seduta in tecnopolimero, telaio cromato e base abbinata.

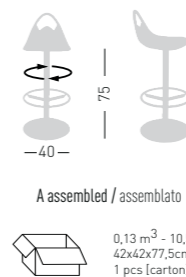

0,13 m³ - 10,5 kg.
42x42x77,5cm
1 pcs [carton]

Frame Finishing & Codes / Finiture Telai e Codici

cod. 25.-- /A

Base color combined with the seat
Colore base abbinata alla seduta

€ **240,00**

SNACK AV



Techno-polymer seat, chromed frame and chromed base.
Seduta in tecnopolimero, telaio cromato e base cromata.

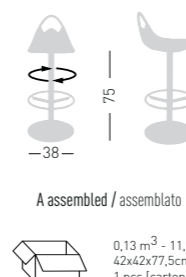

0,13 m³ - 11,5 kg.
42x42x77,5cm
1 pcs [carton]

Frame Finishing & Codes / Finiture Telai e Codici

cod. 25.-- /AV chromed base/base cromata

€ **290,00**

Spyker Stool



Available colors / Colori disponibili

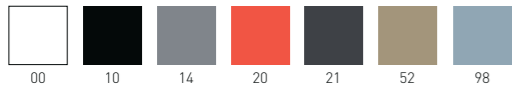

SPYKER STOOL

Stackable techno-polymer stool.
Sgabello impilabile in tecnopolimero.

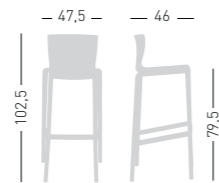

stackable / impilabile (6pcs)
A assembled / assemblato



0,37 m³ - 22,8 kg.
63x49x118cm
4 pcs [carton]

Frame Finishing & Codes / Finiture Telai e Codici

cod.227. __/76A

€ 182,00

SPYKER STOOL B

Stackable techno-polymer stool
with armrests.
Sgabello impilabile in tecnopolimero
con braccioli.

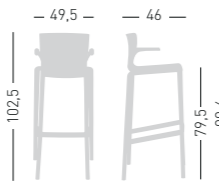

stackable / impilabile (6pcs)
A assembled / assemblato



0,37 m³ - 23,6 kg.
63x49x118cm
4 pcs [carton]

Frame Finishing & Codes / Finiture Telai e Codici

cod.228. __/76A

€ 212,00

Square



Available colors / Colori disponibili



SQUARE

Techno-polymer seat,
chromed frame and combined base.
Seduta in tecnopolimero, telaio
cromato e base abbinata.

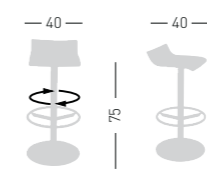

A assembled / assemblato



0,19 m³ - 10,5 kg.
46x46x89cm.
1 pcs [carton]

Frame Finishing & Codes / Finiture Telai e Codici

cod. 44.-- /A

€ 240,00

Base color combined with the seat
Colore base abbinata alla seduta

SQUARE AV

Techno-polymer seat,
chromed frame and base.
Seduta in tecnopolimero, telaio
cromato e base cromata.

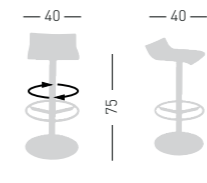

A assembled / assemblato



0,19 m³ - 11 kg.
46x46x89cm.
1 pcs [carton]

Frame Finishing & Codes / Finiture Telai e Codici

cod. 44.-- /AV chromed base/base cromata

€ 290,00



Available colors / Colori disponibili

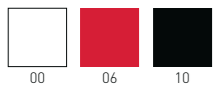

SWING A



Techno-polymer seat with combined base, chromed frame.
Seduta in tecnopolimero con base abbinata, telaio cromato.

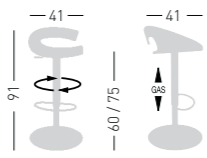

A assembled / assemblato



0,19 m³ - 12 kg.
46x46x89cm.
1 pcs [carton]

Frame Finishing & Codes / Finiture Telai e Codici

cod. 62.-- /A

Base color combined with the seat
Colore base abbinata alla seduta

€ 352,00

SWING AV



Techno-polymer seat, chromed frame and base.
Seduta in tecnopolimero, telaio cromato e base cromata.

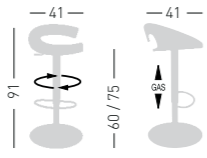

A assembled / assemblato



0,19 m³ - 12,5 kg.
46x46x89cm.
1 pcs [carton]

Frame Finishing & Codes / Finiture Telai e Codici

cod. 62.-- /AV chromed base/base cromata

€ 402,00

Available colors / Colori disponibili



TOM



Techno-polymer seat, chromed frame and combined base.
Seduta in tecnopolimero, telaio cromato e base abbinata.

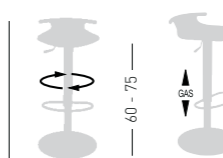

A assembled / assemblato



0,13 m³ - 11 kg.
77x42x42cm.
1 pcs [carton]

Frame Finishing & Codes / Finiture Telai e Codici

cod. 32.-- /A

Base color combined with the seat
Colore base abbinato alla seduta

€ 314,00

TOM AV



Techno-polymer seat, chromed frame and base.
Seduta in tecnopolimero, telaio cromato e base cromata.

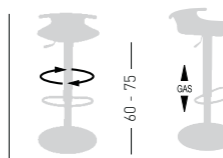

A assembled / assemblato



0,13 m³ - 12 kg.
42x42x77,5cm.
1 pcs [carton]

Frame Finishing & Codes / Finiture Telai e Codici

cod. 32.-- /AV chromed base/base cromata

€ 368,00



Available coverings / Finiture disponibili
Leather / Pelle P (4pcs min.)

**TORINO I
UPHOLSTERED**



Techno-polymer seat upholstered in leather, chromed frame and coloured base.
Seduta in tecnopolimero rivestito in pelle, telaio cromato e base colorata.

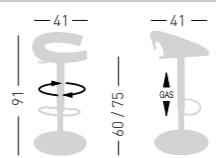

A assembled / assemblato



0,19 m³ - 12,5 kg.
46x46x89cm.
1 pcs (carton)

Frame Finishing & Codes / Finiture Telai e Codici

cod.62.--/IPA

Base color combined with the seat
Colore base abbinata alla seduta

€ **588,00**

Min. order 4pcs
each code
Ordine min 4pz
per codice

Available fabric / Tessuti disponibili
Leather / Pelle P

**TORINO IV
UPHOLSTERED**



Techno-polymer seat upholstered in leather, chromed frame and base.
Seduta in tecnopolimero rivestita in pelle, telaio e base cromata.

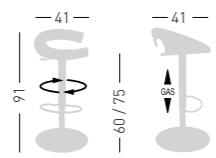

A assembled / assemblato



0,19 m³ - 13 kg.
46x46x89cm.
1 pcs (carton)

Frame Finishing & Codes / Finiture Telai e Codici

cod.62.--/IPAV chromed base/base cromata

€ **646,00**

Min. order 4pcs
each code
Ordine min 4pz
per codice

TABLES Collection

Agile

Studio Eurolinea Design

The multifunctional Agile Table Collection reveals essential aesthetics.

Available with rectangular solid laminate tops, the Agile Collection utilizes techno-polymer legs in different colors, supported by a steel frame.

Agile è una collezione di tavoli multifunzionale dall'estetica ricercata ed essenziale.

Realizzato con piani rettangolari in laminato, Agile utilizza gambe in tecnopolimero in diverse colorazioni, supportate da una cornice in acciaio.

Technopolymer Frame Color / Colore Struttura Tecnopolimero

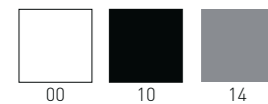

Laminated Top Color / Colore Piano Laminato



Special Finishes / Finiture Speciali

Laminated: Special Laminated Surfaces Wood Effect 25 (p. 383) available on demand
Special Laminated Surfaces Wood Effect 25 (p. 383) disponibile su richiesta
Special Laminated Surfaces Fenix 25 (p. 384) available on demand
Special Laminated Surfaces Fenix 25 (p. 384) disponibile su richiesta

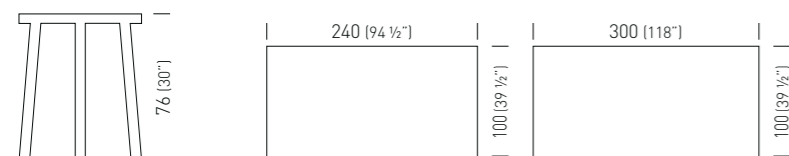

100x240laminated	TAGIL250._._/6H75		0.70m³ / 50kg / 1pcs	€	2.542,00
100x300laminated	TAGIL254._._/6H75		0.90m³ / 60kg / 1pcs	€	3.146,00

Aprio

Forsix Design

Aprio is an extendable rectangular garden table, with an epoxy powder coated aluminum frame and compact laminate top. Thanks to the construction materials and the telescopic extending frame, integrated with the legs, the table lends itself perfectly to both indoor and outdoor use. The patented extension system allows the structure to slide, keeping the legs always at the ends of the table. A quick coupling system allows easy extension by inserting one or two of the leaves that are hidden within the frame itself.

Aprio è un tavolo da giardino rettangolare allungabile, con struttura in alluminio verniciato a polveri epossidiche e piano in Compactop. Grazie ai materiali di costruzione e alla struttura telescopica di allungo, solidale con la gamba, il tavolo si presta perfettamente all'utilizzo sia indoor che outdoor. Il sistema brevettato di allungo consente lo scorrimento della struttura, mantenendo le gambe sempre alle estremità del tavolo. E' possibile scegliere di allungare il tavolo aggiungendo con facilità una o due prolunghe, completamente nascoste all'interno della struttura, grazie ad un sistema di aggancio rapido.



Frame Color / Colore Struttura

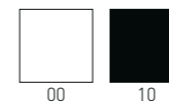

Compactop Color / Colore Piano Compactop

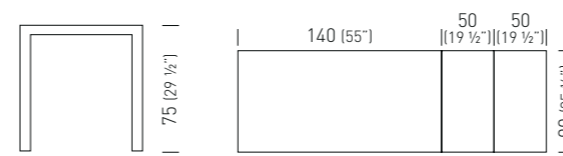
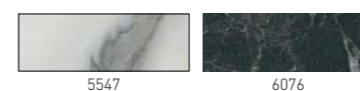

140+50+50x90	TAPRC417._._/H75		0.90m³ / 48kg / 1pcs	€	8.100,00
--------------	------------------	--	----------------------	---	-----------------

Arket

Studio Eurolinea Design

The new Arket table collection is made using basic geometrics - radii and linear sections intersect to achieve distinctly intuitive shapes.

The aluminum bases have three or four spokes with adjustable feet, and the stems come in sections with three or four surfaces.

The table tops are made of steel: the tables are thus painted in a solid color and easily customizable and adaptable to the most prestigious of installations.

La nuova collezione di tavoli Arket è realizzata utilizzando le geometrie più elementari, raggi e sezioni lineari si intersecano per ricavare forme essenziali ed intuitive.

I basamenti, a tre o quattro razze, con piedini regolabili, e gli steli, a sezioni con tre o quattro superfici, sono realizzati in alluminio.

I piani sono realizzati in acciaio: i tavoli sono così verniciati in tinta unita e facilmente personalizzabili ed adattabili alle più prestigiose installazioni.



Colors / Colori

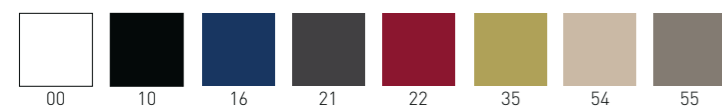

diam.60	TAK3I030._._/H50		0.075m³ / 10kg / 1pcs	€	460,00
diam.70	TAK3I032._._/H50		0.085m³ / 10.5kg / 1pcs	€	484,00
60x60	TAK4I031._._/H50		0.075m³ / 12kg / 1pcs	€	498,00
70x70	TAK4I033._._/H50		0.085m³ / 13.5kg / 1pcs	€	522,00
diam.60	TAK3I030._._/H74		0.075m³ / 10.5kg / 1pcs	€	476,00
diam.70	TAK3I032._._/H74		0.085m³ / 11kg / 1pcs	€	500,00
60x60	TAK4I031._._/H74		0.075m³ / 12.5kg / 1pcs	€	510,00
70x70	TAK4I033._._/H74		0.085m³ / 14kg / 1pcs	€	534,00

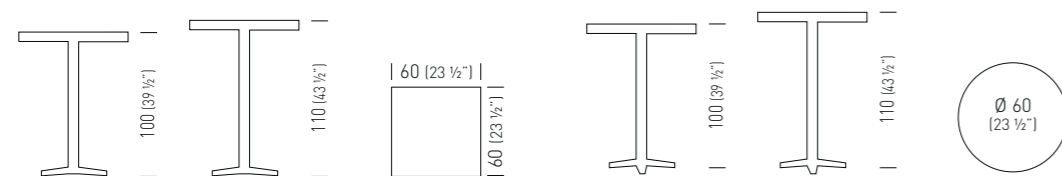

diam.60	TAK3I030._._/H100		0.105m³ / 11kg / 1pcs	€	528,00
60x60	TAK4I031._._/H100		0.105m³ / 13kg / 1pcs	€	568,00
diam.60	TAK3I030._._/H110		0.105m³ / 11kg / 1pcs	€	532,00
60x60	TAK4I031._._/H110		0.105m³ / 13kg / 1pcs	€	574,00

Arket Porcelain

Forsix Design



The Porcelain stoneware tops stand out for their excellent technical performance, ideal for the most delicate uses where maximum hygiene and resistance must be guaranteed. Porcelain tops are compatible with foodstuffs, resistant to fungi and molds, suitable for both indoor and outdoor use, resistant to frost, heat and high temperatures, they can be cleaned very easily while maintaining the characteristics of the surface.

I piani in Gres Porcellanato si distinguono per le eccellenti performance tecniche, ideali negli impieghi più delicati nei quali è necessario garantire la massima igiene e resistenza. I piani Porcelain sono compatibili con le sostanze alimentari, resistenti a funghi e muffe, ideali ad un utilizzo sia interno che esterno, resistenti al gelo, al calore alle alte temperature, si possono pulire con estrema facilità mantenendo inalterate le caratteristiche della superficie.

Frame Color / Colore Struttura

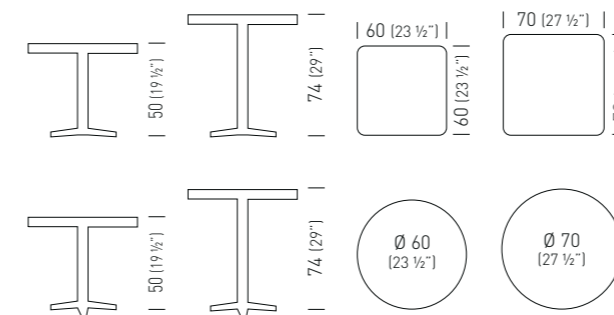
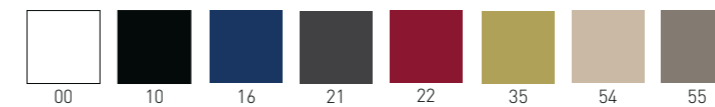

diam.60	TAK3P134._._/H50		0.57m³ / 19.5kg / 1pc	€	1.012,00
diam.70	TAK3P136._._/H50		0.57m³ / 22.5kg / 1pc	€	1.188,00
60x60	TAK4P135._._/H50		0.57m³ / 22.5kg / 1pc	€	898,00
70x70	TAK4P137._._/H50		0.57m³ / 25.5kg / 1pc	€	1.210,00
diam.60	TAK3P134._._/H74		0.57m³ / 20kg / 1pc	€	1.012,00
diam.70	TAK3P136._._/H74		0.57m³ / 23kg / 1pc	€	1.188,00
60x60	TAK4P135._._/H74		0.57m³ / 23kg / 1pc	€	898,00
70x70	TAK4P137._._/H74		0.57m³ / 26kg / 1pc	€	1.210,00

Min. order 10pcs each code
Ordine min 10pz per codice

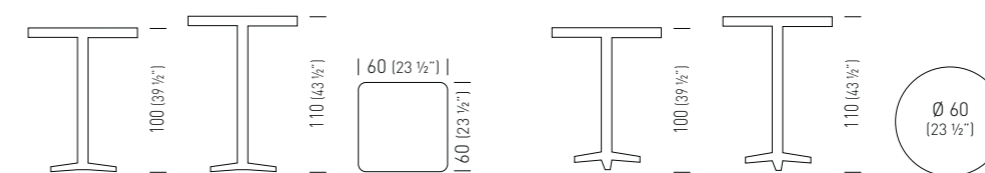

diam.60	TAK3P134._._/H100		0.60m³ / 20.1kg / 1pcs	€	1.012,00
60x60	TAK4P135._._/H100		0.60m³ / 23.1kg / 1pcs	€	898,00
diam.60	TAK3P134._._/H110		0.60m³ / 20.2kg / 1pcs	€	1.012,00
60x60	TAK4P135._._/H110		0.60m³ / 23.2kg / 1pcs	€	898,00

Min. order 10pcs each code
Ordine min 10pz per codice

Arket Plus

Forsix Design

Arket Plus Collection is made using basic geometrics, achieving distinctly intuitive shapes. The table tops are made of steel, the three spokes bases are made of co-injected metal and technopolymer. Stem and cross are made in aluminum, and provided with flip-top joint. The shape of the base and the flip-top mechanism allow the table to easily fold and stack, space-saving.

La Collezione di tavoli Arket Plus è realizzata utilizzando le geometrie più elementari, ottenendo così forme essenziali ed intuitive. I piani del tavolo sono realizzati in acciaio, la base a tre razze è costituita da una struttura in metallo co-iniettata con tecnopolimero. Colonna e crociera sono realizzate in alluminio, dotate di giunto per la rotazione del piano. La forma della base e la meccanica che permette la rotazione del piano rendono il tavolo facilmente accatastabile in spazi ridotti.



Colors / Colori

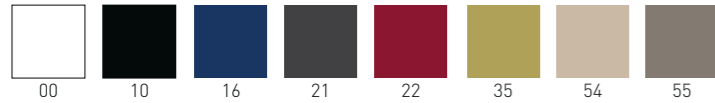

diam.60	TAKPI030.____/H75		0.133m³ / 11.5kg / 1pcs	€	480,00
60x60	TAKPI031.____/H75		0.133m³ / 13.1kg / 1pcs	€	514,00

Azione Adjustable Desk

Forsix Design

"Azione", Sit-Stand desk table, height adjustable, equipped with bluetooth controller and anti-collision technology.

"Azione", tavolo scrivania Sit-Stand, regolabile elettricamente in altezza, dotato di controller bluetooth e tecnologia anticollisione.



Frame Color / Colore Struttura

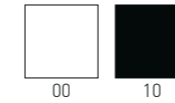

Laminated Top Color / Colore Piano Laminato

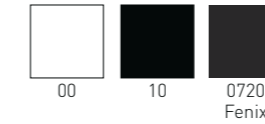

EN60335-1

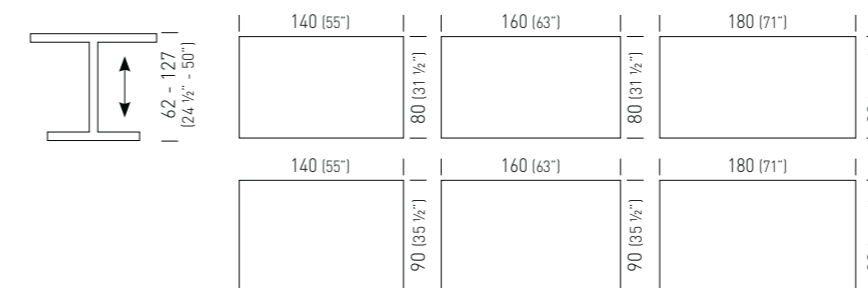

80x140laminated	TAZNL450.____-/H62R		0.67m³ / 26kg / 1pcs	€	2.292,00
80x140lam.fenix	TAZNL450.0720-_/H62R		0.67m³ / 26kg / 1pcs	€	2.742,00
80x160laminated	TAZNL451.____-/H62R		0.70m³ / 28kg / 1pcs	€	2.356,00
80x160lam.fenix	TAZNL451.0720-_/H62R		0.70m³ / 28kg / 1pcs	€	2.868,00
80x180laminated	TAZNL452.____-/H62R		0.75m³ / 30kg / 1pcs	€	2.420,00
80x180lam.fenix	TAZNL452.0720-_/H62R		0.75m³ / 30kg / 1pcs	€	2.996,00
90x140laminated	TAZNL453.____-/H62R		0.70m³ / 28kg / 1pcs	€	2.356,00
90x140lam.fenix	TAZNL453.0720-_/H62R		0.70m³ / 28kg / 1pcs	€	2.868,00
90x160laminated	TAZNL454.____-/H62R		0.75m³ / 30kg / 1pcs	€	2.410,00
90x160lam.fenix	TAZNL454.0720-_/H62R		0.75m³ / 30kg / 1pcs	€	2.996,00
90x180laminated	TAZNL455.____-/H62R		0.80m³ / 33kg / 1pcs	€	2.484,00
90x180lam.fenix	TAZNL455.0720-_/H62R		0.80m³ / 33kg / 1pcs	€	3.122,00

Banket

Studio Eurolinea Design

High table, Compactop or Laminated table top, painted metal frame.

Tavolo alto con struttura in metallo verniciato, piano in Compactop o Laminato.



Only for Compactop
Solo per Compactop



Frame Color / Colore Struttura

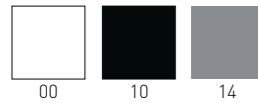

Compactop Color / Colore Piano Compactop

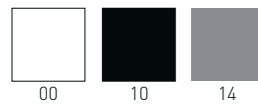

Laminated Top Color / Colore Piano Laminato



Special Finishes / Finiture Speciali

Compactop: Special Compactop Surfaces Fullcolor (p. 377) available on demand (min. 5pcs each code).
Special Compactop Surfaces Fullcolor (p. 377) disponibile su richiesta (min. 5pcs per codice).
Special Compactop Surfaces 10 (p. 378) available on demand (min. 20pcs each code).
Special Compactop Surfaces 10 (p. 378) disponibile su richiesta (min. 20pcs per codice).
Laminated: Special Laminated Surfaces Wood Effect 25 (p. 383) available on demand (min. 20pcs each code).
Special Laminated Surfaces Wood Effect 25 (p. 383) disponibile su richiesta (min. 20pcs per codice).
Special Laminated Surfaces Fenix 25 (p. 384) available on demand (min. 20pcs each code).
Special Laminated Surfaces Fenix 25 (p. 384) disponibile su richiesta (min. 20pcs per codice).

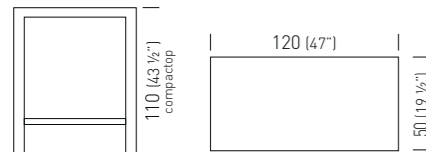

120x50compactop	TBNKC800.____/H110		0.47m³ / 18kg / 1pcs	€	710,00
120x50laminated	TBNKL804.____/H110		0.47m³ / 18kg / 1pcs	€	586,00

Bristol

Forsix Design

The Bristol table is characterized by bold lines and tone-on-tone colours, suitable for setting off to a tee the most refined hospitality environments. Its top and four-spur base, equipped with adjustable feet, are in epoxy powder coated steel treated for outdoor use. Il tavolo Bristol è caratterizzato da linee decise e dai colori tono su tono, adatto a diventare protagonista degli ambienti dell'ospitalità più ricercati. Il piano e il basamento a quattro razze, dotato di piedini regolabili, sono realizzati in acciaio verniciato a polveri epossidiche con trattamento per esterno.



Only Steel and Compactop
Solo piani Acciaio e Compactop

Frame Color / Colore Struttura

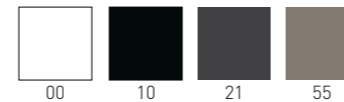

Compactop Color / Colore Piano Compactop

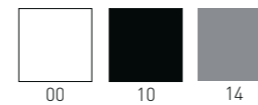

Laminated Top Color / Colore Piano Laminato



Special Finishes / Finiture Speciali

Compactop: Special Compactop Surfaces Fullcolor (p. 377) available on demand (min. 5pcs each code).
Special Compactop Surfaces Fullcolor (p. 377) disponibile su richiesta (min. 5pcs per codice).
Special Compactop Surfaces Fenix (p. 380) available on demand (min. 20pcs each code).
Special Compactop Surfaces Fenix (p. 380) disponibile su richiesta (min. 20pcs per codice).
Special Compactop Surfaces 10 (p. 378) available on demand (min. 20pcs each code).
Special Compactop Surfaces 10 (p. 378) disponibile su richiesta (min. 20pcs per codice).

Laminated: Special Laminated Surfaces Wood Effect (p. 383) available on demand (min. 20pcs each code).
Special Laminated Surfaces Wood Effect (p. 383) disponibile su richiesta (min. 20pcs per codice).
Special Laminated Surfaces Fenix (p. 384) available on demand (min. 20pcs each code).
Special Laminated Surfaces Fenix (p. 384) disponibile su richiesta (min. 20pcs per codice).

Steel Top Color / Colore Piano Acciaio

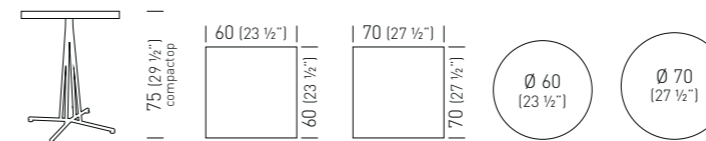
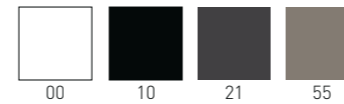

60x60 laminated	TBRSL383.____/H75		0.28m³ / 15kg / 1pc	€	412,00
70x70 laminated	TBRSL385.____/H75		0.30m³ / 18kg / 1pc	€	424,00
diam.60 laminated	TBRSL382.____/H75		0.28m³ / 14kg / 1pc	€	424,00
diam.70 laminated	TBRSL384.____/H75		0.30m³ / 15kg / 1pc	€	470,00

60x60 compactop	TBRSC363.____/H75		0.28m³ / 14.5kg / 1pc	€	456,00
70x70 compactop	TBRSC369.____/H75		0.30m³ / 18kg / 1pc	€	488,00
diam.60 compactop	TBRSC360.____/H75		0.28m³ / 14kg / 1pc	€	508,00
diam.70 compactop	TBRSC366.____/H75		0.30m³ / 15kg / 1pc	€	558,00

60x60 steel	TBRSI377.____/H75		0.28m³ / 16kg / 1pc	€	500,00
70x70 steel	TBRSI379.____/H75		0.30m³ / 21kg / 1pc	€	524,00
diam.60 steel	TBRSI376.____/H75		0.28m³ / 14kg / 1pc	€	498,00
diam.70 steel	TBRSI378.____/H75		0.30m³ / 18kg / 1pc	€	522,00

Charme

Studio Eurolinea Design

Elegance and essential shapes find a new expression in the Charme table, a proposal designed for workspace and hospitality environments, which is characterized by the particular design of the metal legs.

The regular shapes harmonize each other, creating a product also suitable for conviviality, thanks to the top in "Iron" composite material which highlights great stability and resistance.

Eleganza ed essenzialità trovano una nuova espressione nel tavolo Charme, una proposta ideata per lo spazio di lavoro e dell'ospitalità, che si caratterizza per il particolare design delle gambe in metallo.

Le forme regolari si armonizzano tra loro, dando vita a un progetto improntato anche alla convivialità, grazie al piano in materiale composito "Iron" dalla grande stabilità e resistenza.

Colors / Colori

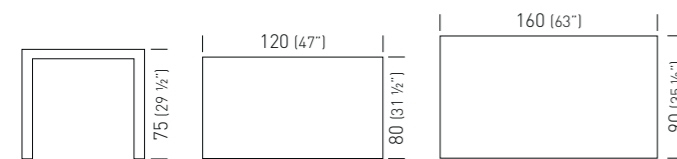
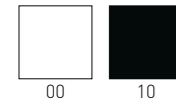

80x120	TCHAI400._/H75		0.48m³ / 20kg / 1pcs	€	1.490,00
90x160	TCHAI402._/H75		0.72m³ / 22kg / 1pcs	€	1.780,00



Claro

Studio Eurolinea Design

Table with co-injected metal frame with techno polymer, Compactop or laminated top. Suitable for outdoor purpose with Compactop.

Tavolo con struttura in metallo sovrastampato con tecnopolimero, piano in Compactop o laminato.

Con piano Compactop, adatto anche all'uso esterno.



Frame Color / Colore Struttura

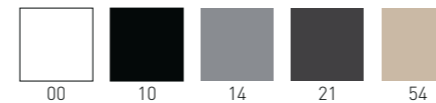

Compactop Color / Colore Piano Compactop

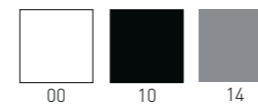

Laminated Top Color / Colore Piano Laminato



Special Finishes / Finiture Speciali

Compactop Special Compactop Surfaces 10 (p. 378) available on demand (min. 20pcs each code).
Laminated: Special Compactop Surfaces 10 (p. 378) disponibile su richiesta (min. 20pcs per codice).
 Special Laminated Surfaces Wood Effect 25 (p. 383) available on demand (min. 20pcs each code).
 Special Laminated Surfaces Wood Effect 25 (p. 383) disponibile su richiesta (min. 20pcs per codice).
 Special Laminated Surfaces Fenix 25 (p. 384) available on demand (min. 20pcs each code).
 Special Laminated Surfaces Fenix 25 (p. 384) disponibile su richiesta (min. 20pcs per codice).

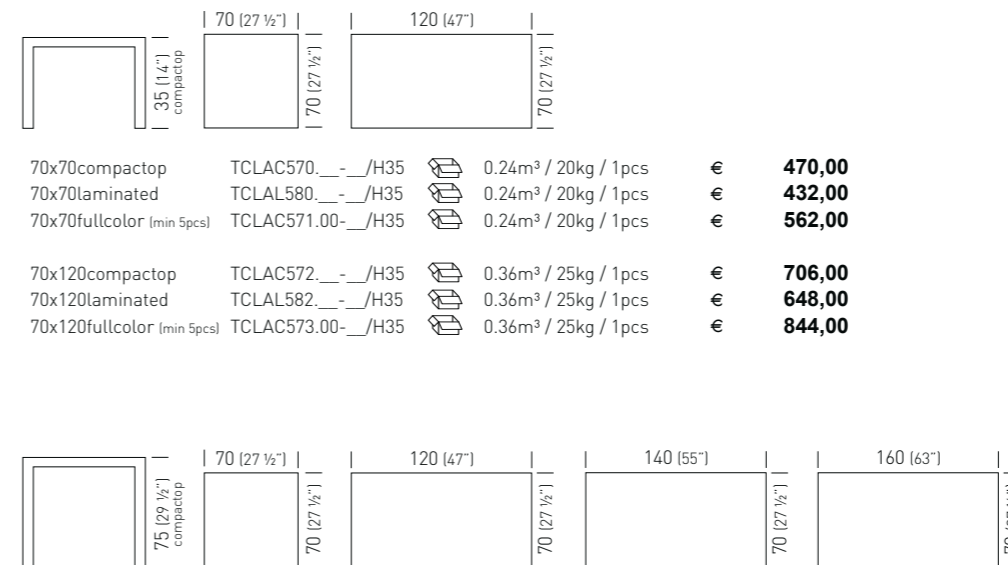

70x70compactop	TCLAC570._-/H35		0.24m³ / 20kg / 1pcs	€	470,00
70x70laminated	TCLAL580._-/H35		0.24m³ / 20kg / 1pcs	€	432,00
70x70fullcolor (min 5pcs)	TCLAC571.00-_/H35		0.24m³ / 20kg / 1pcs	€	562,00
70x120compactop	TCLAC572._-/H35		0.36m³ / 25kg / 1pcs	€	706,00
70x120laminated	TCLAL582._-/H35		0.36m³ / 25kg / 1pcs	€	648,00
70x120fullcolor (min 5pcs)	TCLAC573.00-_/H35		0.36m³ / 25kg / 1pcs	€	844,00
70x140compactop	TCLAC574._-/H75		0.41m³ / 31kg / 1pcs	€	940,00
70x140laminated	TCLAL584._-/H75		0.41m³ / 31kg / 1pcs	€	864,00
70x140fullcolor (min 5pcs)	TCLAC575.00-_/H75		0.41m³ / 31kg / 1pcs	€	1.128,00
70x160compactop	TCLAC576._-/H75		0.46m³ / 35kg / 1pcs	€	1.174,00
70x160laminated	TCLAL586._-/H75		0.46m³ / 35kg / 1pcs	€	1.082,00
70x160fullcolor (min 5pcs)	TCLAC577.00-_/H75		0.46m³ / 35kg / 1pcs	€	1.408,00



Only for Compactop
Solo per Compactop



Frame Color / Colore Struttura

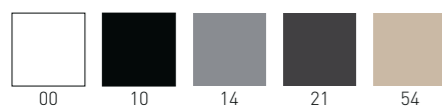

Compactop Color / Colore Piano Compactop

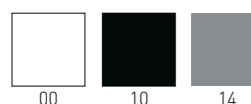

Laminated Top Color / Colore Piano Laminato



Special Finishes / Finiture Speciali

Compactop: Special Compactop Surfaces 10 (p. 378) available on demand (min. 20pcs each code).
Special Compactop Surfaces 10 (p. 378) disponibile su richiesta (min. 20pcs per codice).
Laminated: Special Laminated Surfaces Wood Effect 25 (p. 383) available on demand (min. 20pcs each code).
Special Laminated Surfaces Wood Effect 25 (p. 383) disponibile su richiesta (min. 20pcs per codice).
Special Laminated Surfaces Fenix 25 (p. 384) available on demand (min. 20pcs each code).
Special Laminated Surfaces Fenix 25 (p. 384) disponibile su richiesta (min. 20pcs per codice).

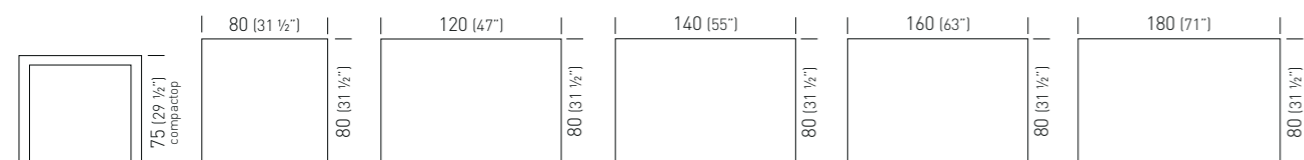

80x80compactop	TCLAC590.___/H75		0.24m ³ / 31kg / 1pcs	€	548,00
80x80laminated	TCLAL600.___/H75		0.24m ³ / 31kg / 1pcs	€	508,00
80x80fullcolor (min 5pcs)	TCLAC591.00-_/H75		0.24m ³ / 31kg / 1pcs	€	656,00
80x120compactop	TCLAC592.___/H75		0.36m ³ / 38kg / 1pcs	€	782,00
80x120laminated	TCLAL602.___/H75		0.36m ³ / 38kg / 1pcs	€	724,00
80x120fullcolor (min 5pcs)	TCLAC593.00-_/H75		0.36m ³ / 38kg / 1pcs	€	936,00
80x140compactop	TCLAC594.___/H75		0.41m ³ / 40kg / 1pcs	€	1.012,00
80x140laminated	TCLAL604.___/H75		0.41m ³ / 40kg / 1pcs	€	940,00
80x140fullcolor (min 5pcs)	TCLAC595.00-_/H75		0.41m ³ / 40kg / 1pcs	€	1.220,00
80x160compactop	TCLAC596.___/H75		0.46m ³ / 42kg / 1pcs	€	1.250,00
80x160laminated	TCLAL606.___/H75		0.46m ³ / 42kg / 1pcs	€	1.158,00
80x160fullcolor (min 5pcs)	TCLAC597.00-_/H75		0.46m ³ / 42kg / 1pcs	€	1.500,00
80x180compactop	TCLAC598.___/H75		0.60m ³ / 44kg / 1pcs	€	1.346,00
80x180laminated	TCLAL608.___/H75		0.60m ³ / 44kg / 1pcs	€	1.194,00
80x180fullcolor (min 5pcs)	TCLAC599.00-_/H75		0.60m ³ / 44kg / 1pcs	€	1.618,00



Only for Compactop
Solo per Compactop

Frame Color / Colore Struttura

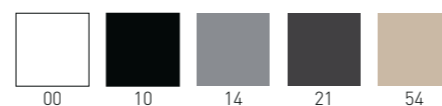

Compactop Color / Colore Piano Compactop

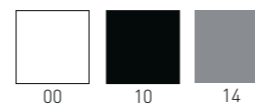

Laminated Top Color / Colore Piano Laminato



Special Finishes / Finiture Speciali

Compactop: Special Compactop Surfaces 10 (p. 378) available on demand (min. 20pcs each code).
Special Compactop Surfaces 10 (p. 378) disponibile su richiesta (min. 20pcs per codice).
Laminated: Special Laminated Surfaces Wood Effect 25 (p. 383) available on demand (min. 20pcs each code).
Special Laminated Surfaces Wood Effect 25 (p. 383) disponibile su richiesta (min. 20pcs per codice).
Special Laminated Surfaces Fenix 25 (p. 384) available on demand (min. 20pcs each code).
Special Laminated Surfaces Fenix 25 (p. 384) disponibile su richiesta (min. 20pcs per codice).

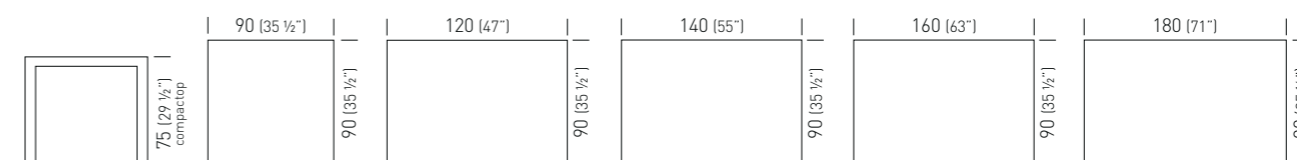

90x90compactop	TCLAC610.___/H75		0.54m ³ / 33kg / 1pcs	€	636,00
90x90laminated	TCLAL620.___/H75		0.54m ³ / 33kg / 1pcs	€	598,00
90x90fullcolor (min 5pcs)	TCLAC611.00-_/H75		0.54m ³ / 33kg / 1pcs	€	762,00
90x120compactop	TCLAC612.___/H75		0.54m ³ / 36kg / 1pcs	€	882,00
90x120laminated	TCLAL622.___/H75		0.54m ³ / 36kg / 1pcs	€	828,00
90x120fullcolor (min 5pcs)	TCLAC613.00-_/H75		0.54m ³ / 36kg / 1pcs	€	1.058,00
90x140compactop	TCLAC614.___/H75		0.65m ³ / 39kg / 1pcs	€	1.118,00
90x140laminated	TCLAL624.___/H75		0.65m ³ / 39kg / 1pcs	€	1.042,00
90x140fullcolor (min 5pcs)	TCLAC615.00-_/H75		0.65m ³ / 39kg / 1pcs	€	1.342,00
90x160compactop	TCLAC616.___/H75		0.75m ³ / 41kg / 1pcs	€	1.352,00
90x160laminated	TCLAL626.___/H75		0.75m ³ / 41kg / 1pcs	€	1.260,00
90x160fullcolor (min 5pcs)	TCLAC617.00-_/H75		0.75m ³ / 41kg / 1pcs	€	1.622,00
90x180compactop	TCLAC618.___/H75		0.80m ³ / 43kg / 1pcs	€	1.474,00
90x180laminated	TCLAL628.___/H75		0.80m ³ / 43kg / 1pcs	€	1.320,00
90x180fullcolor (min 5pcs)	TCLAC619.00-_/H75		0.80m ³ / 43kg / 1pcs	€	1.770,00
120x120laminated	TCLAL670.___/H75		0.70m ³ / 38kg / 1pcs	€	1.006,00
120x180laminated	TCLAL672.___/H75		1.00m ³ / 45kg / 1pcs	€	1.514,00

Claro Slim

Studio Eurolinea Design

Table with co-injected metal frame with techno polymer, Compactop or laminated top. Suitable for outdoor purpose with Compactop.
Tavolo con struttura in metallo sovrastampato con tecnopolimero, piano in Compactop o laminato. Con piano Compactop, adatto anche all'uso esterno.

Frame Color / Colore Struttura

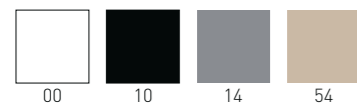

Compactop Color / Colore Piano Compactop

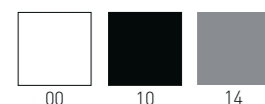

Laminated Top Color / Colore Piano Laminato



Special Finishes / Finiture Speciali

Compactop: Special Compactop Surfaces 10 (p. 378) available on demand (min. 20pcs each code)
Special Compactop Surfaces 10 (p. 378) disponibile su richiesta (min. 20pcs per codice).
Laminated: Special Laminated Surfaces Wood Effect 25 (p. 383) available on demand (min. 20pcs each code)
Special Laminated Surfaces Wood Effect 25 (p. 383) disponibile su richiesta (min. 20pcs per codice)
Special Laminated Surfaces Fenix 25 (p. 384) available on demand (min. 20pcs each code)
Special Laminated Surfaces Fenix 25 (p. 384) disponibile su richiesta (min. 20pcs per codice)

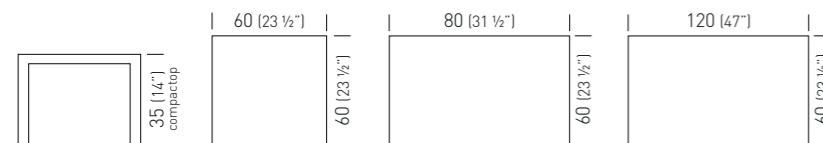

60x60compactop	TCLAC640.___/H35		0.15m ³ / 17kg / 1pcs	€	436,00
60x60laminated	TCLAL650.___/H35		0.15m ³ / 17kg / 1pcs	€	412,00
60x60fullcolor (min 5pcs)	TCLAC641.00-_/H35		0.15m ³ / 17kg / 1pcs	€	530,00
60x80compactop	TCLAC642.___/H35		0.18m ³ / 19kg / 1pcs	€	462,00
60x80laminated	TCLAL652.___/H35		0.18m ³ / 19kg / 1pcs	€	436,00
60x80fullcolor (min 5pcs)	TCLAC643.00-_/H35		0.18m ³ / 19kg / 1pcs	€	558,00
60x120compactop	TCLAC644.___/H35		0.36m ³ / 23kg / 1pcs	€	640,00
60x120laminated	TCLAL654.___/H35		0.36m ³ / 23kg / 1pcs	€	602,00
60x120fullcolor (min 5pcs)	TCLAC645.00-_/H35		0.36m ³ / 23kg / 1pcs	€	770,00

Claro Slim

Studio Eurolinea Design



Only for Compactop
Solo per Compactop



Only for Compactop
Solo per Compactop

Frame Color / Colore Struttura

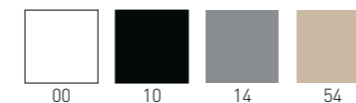

Compactop Color / Colore Piano Compactop

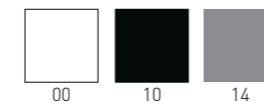

Laminated Top Color / Colore Piano Laminato



Special Finishes / Finiture Speciali

Compactop: Special Compactop Surfaces 10 (p. 378) available on demand (min. 20pcs each code)
Special Compactop Surfaces 10 (p. 378) disponibile su richiesta (min. 20pcs per codice).
Laminated: Special Laminated Surfaces Wood Effect 25 (p. 383) available on demand (min. 20pcs each code)
Special Laminated Surfaces Wood Effect 25 (p. 383) disponibile su richiesta (min. 20pcs per codice)
Special Laminated Surfaces Fenix 25 (p. 384) available on demand (min. 20pcs each code)
Special Laminated Surfaces Fenix 25 (p. 384) disponibile su richiesta (min. 20pcs per codice)

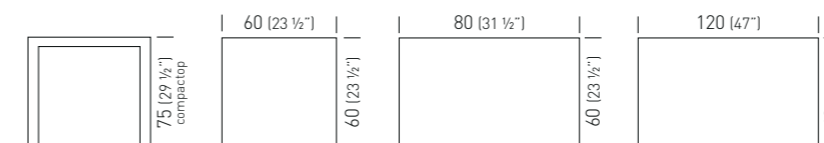

60x60compactop	TCLAC640.___/H75		0.15m ³ / 19kg / 1pcs	€	454,00
60x60laminated	TCLAL650.___/H75		0.15m ³ / 19kg / 1pcs	€	428,00
60x60fullcolor (min 5pcs)	TCLAC641.00-_/H75		0.15m ³ / 19kg / 1pcs	€	544,00
60x80compactop	TCLAC642.___/H75		0.18m ³ / 21kg / 1pcs	€	478,00
60x80laminated	TCLAL652.___/H75		0.18m ³ / 21kg / 1pcs	€	454,00
60x80fullcolor (min 5pcs)	TCLAC643.00-_/H75		0.18m ³ / 21kg / 1pcs	€	576,00
60x120compactop	TCLAC644.___/H75		0.36m ³ / 25kg / 1pcs	€	656,00
60x120laminated	TCLAL654.___/H75		0.36m ³ / 25kg / 1pcs	€	618,00
60x120fullcolor (min 5pcs)	TCLAC645.00-_/H75		0.36m ³ / 25kg / 1pcs	€	788,00

Claro Slim

Studio Eurolinea Design

High table, Compactop or Laminated table top, painted metal frame.
Tavolo alto con struttura in metallo verniciato, piano in Compactop o Laminato.



Only for Compactop
Solo per Compactop



Frame Color / Colore Struttura

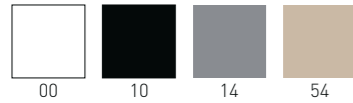

Compactop Color / Colore Piano Compactop

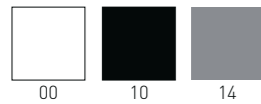

Laminated Top Color / Colore Piano Laminato



Special Finishes / Finiture Speciali

Compactop: Special Compactop Surfaces 10 (p.325) available on demand (min. 20pcs each code)
Special Compactop Surfaces 10 (p. 325) disponibile su richiesta (min. 20pcs per codice).
Laminated: Special Laminated Surfaces Wood Effect 25 (p. 383) available on demand (min. 20pcs each code)
Special Laminated Surfaces Wood Effect 25 (p. 383) disponibile su richiesta (min. 20pcs per codice)
Special Laminated Surfaces Fenix 25 (p. 384) available on demand (min. 20pcs each code)
Special Laminated Surfaces Fenix 25 (p. 384) disponibile su richiesta (min. 20pcs per codice)

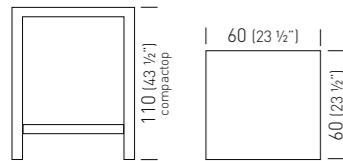

60x60compactop	TCLAC640.____/H110		0.20m³ / 21kg / 1pcs	€	530,00
60x60laminated	TCLAL650.____/H110		0.20m³ / 21kg / 1pcs	€	504,00
60x60fullcolor (min 5pcs)	TCLAC641.00-____/H110		0.20m³ / 21kg / 1pcs	€	620,00

Flipaway

Forsix Design

"Flipaway" table for conference environment, provided with laminated table top and breaking castors, ensures complete frontal stackability.
"Flipaway": tavolo con piano in laminato adatto ad ambienti conferenza, accatatabile frontalmente e dotato di ruote con freno.



Frame Color / Colore Struttura

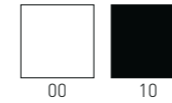

Laminated Top Color / Colore Piano Laminato

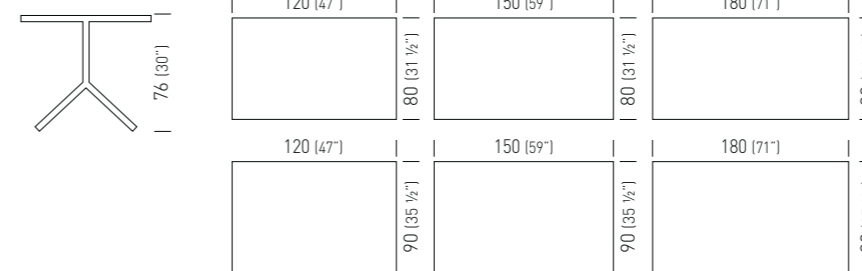
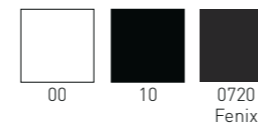

80x120laminated	TFLPL460.____-/H76		0.6m³ / 27kg / 1pcs	€	848,00
80x120lam.fenix	TFLPL460.0720-____/H76		0.6m³ / 27kg / 1pcs	€	908,00
80x150laminated	TFLPL461.____-/H76		0.7m³ / 30kg / 1pcs	€	1.064,00
80x150lam.fenix	TFLPL461.0720-____/H76		0.7m³ / 30kg / 1pcs	€	1.114,00
80x180laminated	TFLPL462.____-/H76		0.8m³ / 33kg / 1pcs	€	1.138,00
80x180lam.fenix	TFLPL462.0720-____/H76		0.8m³ / 33kg / 1pcs	€	1.210,00
90x120laminated	TFLPL463.____-/H76		0.6m³ / 30kg / 1pcs	€	896,00
90x120lam.fenix	TFLPL463.0720-____/H76		0.6m³ / 30kg / 1pcs	€	958,00
90x150laminated	TFLPL464.____-/H76		0.7m³ / 33kg / 1pcs	€	1.114,00
90x150lam.fenix	TFLPL464.0720-____/H76		0.7m³ / 33kg / 1pcs	€	1.186,00
90x180laminated	TFLPL465.____-/H76		0.8m³ / 36kg / 1pcs	€	1.186,00
90x180lam.fenix	TFLPL465.0720-____/H76		0.8m³ / 36kg / 1pcs	€	1.258,00

Format

Studio Eurolinea Design

Table with metal painted frame and Compactop table top.
Suitable for outdoor purpose. Adjustable feet.
Tavolo con struttura in metallo verniciato, piano in Compactop.
Adatto anche all'uso esterno. Piedini regolabili.



Frame Color / Colore Struttura

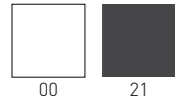

Compactop Color / Colore Piano Compactop

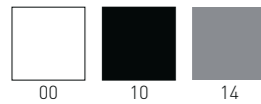

Special Finishes / Finiture Speciali

Compactop: Special Compactop Surfaces Fullcolor (p. 377) available on demand (min. 5pcs each code).
Special Compactop Surfaces Fullcolor (p. 377) disponibile su richiesta (min. 5pcs per codice).
Special Compactop Surfaces 10 (p. 378) available on demand (min. 20pcs each code).
Special Compactop Surfaces 10 (p. 378) disponibile su richiesta (min. 20pcs per codice).

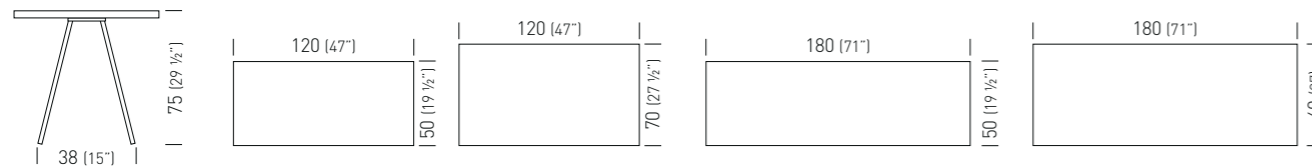

120x50	TFORC840._._/H75	0.47m³ / 23kg / 1pcs	€ 788,00
120x70	TFORC842._._/H75	0.48m³ / 24kg / 1pcs	€ 802,00
180x50	TFORC844._._/H75	0.80m³ / 25kg / 1pcs	€ 812,00
180x69	TFORC846._._/H75	0.80m³ / 26kg / 1pcs	€ 854,00

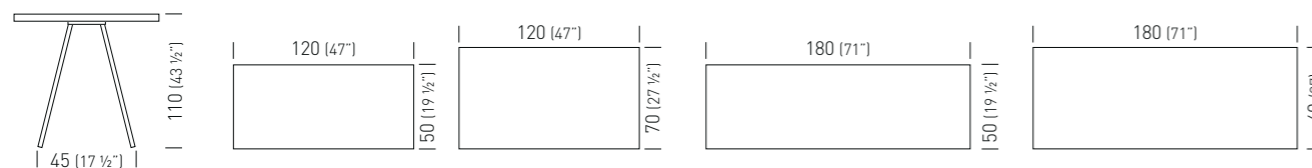

120x50	TFORC840._._/H110	0.47m³ / 25kg / 1pcs	€ 812,00
120x70	TFORC842._._/H110	0.48m³ / 26kg / 1pcs	€ 830,00
180x50	TFORC844._._/H110	0.80m³ / 27kg / 1pcs	€ 840,00
180x69	TFORC846._._/H110	0.80m³ / 28kg / 1pcs	€ 882,00

Glitter

Forsix Design

The Glitter table oozes simplicity and practicality. The sturdy steel structure with its three support points is also available at poseur height and features essential minimalist design, in order to fit in discreetly to any environment. Base are in epoxy powder coated steel with outdoor treatment, table tops are available in Compactop or Laminated.
Il tavolo Glitter esprime semplicità e praticità. La stabile struttura in acciaio a tre punti di appoggio, disponibile anche nell'altezza snack, è caratterizzata da un design essenziale e minimale, per potersi relazionare con discrezione agli ambienti di utilizzo. Le basi sono realizzate in acciaio verniciato a polveri epossidiche con trattamento per esterno, i piani possono essere realizzati in Compactop o Laminato.



Frame Color / Colore Struttura

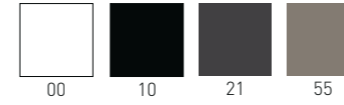

Compactop Color / Colore Piano Compactop

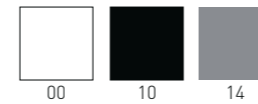

Laminated Top Color / Colore Piano Laminato



Special Finishes / Finiture Speciali

Compactop: Special Compactop Surfaces Fullcolor (p. 377) available on demand (min. 5pcs each code).
Special Compactop Surfaces Fullcolor (p. 377) disponibile su richiesta (min. 5pcs per codice).
Special Compactop Surfaces Fenix (p. 380) available on demand (min. 20pcs each code).
Special Compactop Surfaces Fenix (p. 380) disponibile su richiesta (min. 20pcs per codice).
Special Compactop Surfaces 10 (p. 378) available on demand (min. 20pcs each code).
Special Compactop Surfaces 10 (p. 378) disponibile su richiesta (min. 20pcs per codice).

Laminated: Special Laminated Surfaces Wood Effect (p. 383) available on demand (min. 20pcs each code).
Special laminated Surfaces Wood Effect (p. 383) disponibile su richiesta (min. 20pcs per codice).
Special Laminated Surfaces Fenix (p. 384) available on demand (min. 20pcs each code).
Special laminated Surfaces Fenix (p. 384) disponibile su richiesta (min. 20pcs per codice).

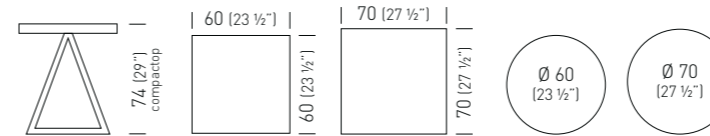

60x60 laminated	TGLTL557._._/H74	0.23m³ / 12.4kg / 1pc	€ 376,00
70x70 laminated	TGLTL559._._/H74	0.25m³ / 15.4kg / 1pc	€ 390,00
diam.60 laminated	TGLTL556._._/H74	0.23m³ / 11.4kg / 1pc	€ 390,00
diam.70 laminated	TGLTL558._._/H74	0.25m³ / 12.4kg / 1pc	€ 436,00
60x60 compactop	TGLTC543._._/H74	0.23m³ / 11.9kg / 1pc	€ 460,00
70x70 compactop	TGLTC549._._/H74	0.25m³ / 15.4kg / 1pc	€ 498,00
diam.60 compactop	TGLTC540._._/H74	0.23m³ / 11.4kg / 1pc	€ 524,00
diam.70 compactop	TGLTC546._._/H74	0.25m³ / 12.4kg / 1pc	€ 582,00

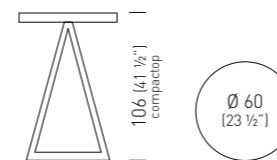

diam.60 laminated	TGLTL556._._/H105	0.25m³ / 12.05kg / 1pc	€ 444,00
diam.60 compactop	TGLTC540._._/H105	0.25m³ / 12.05kg / 1pc	€ 578,00

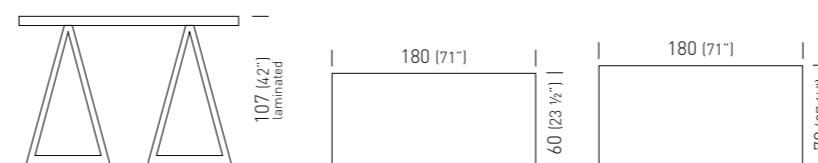

60x180 laminated	TGLTL561._._/2H105	0.39m³ / 27.5kg / 1pc	€ 1.018,00
70x180 laminated	TGLTL562._._/2H105	0.39m³ / 29.9kg / 1pc	€ 1.062,00

Hug

Studio Eurolinea Design

The Hug collection is characterized by the possibility of combine table tops in Compactop or Steel, which can also be used outdoors, or in Laminate, for the most specific indoor settings. The table is made with a 4-star aluminum base, equipped with adjustable feet, and aluminum column and cross.

La collezione Hug è caratterizzata dalla possibilità di poter abbinare piani tavoli in Compactop e Steel, utilizzabili anche all'esterno, o in Laminato per le più specifiche ambientazioni indoor. Il tavolo è realizzato con basamento 4 razze in alluminio, dotato di piedini regolabili, e da colonna e crociera in alluminio.

Frame Color / Colore Struttura

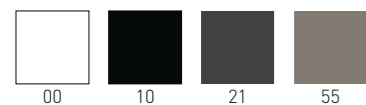

Compactop Color / Colore Piano Compactop



Laminated Top Color / Colore Piano Laminato



Special Finishes / Finiture Speciali

Compactop: Special Compactop Surfaces Fullcolor (p. 377) available on demand (min. 5pcs each code).
Special Compactop Surfaces Fullcolor (p. 377) disponibile su richiesta (min. 5pcs per codice).
Special Compactop Surfaces Fenix (p. 380) available on demand (min. 20pcs each code).
Special Compactop Surfaces Fenix (p. 380) disponibile su richiesta (min. 20pcs per codice).
Special Compactop Surfaces 10 (p. 378) available on demand (min. 20pcs each code).
Special Compactop Surfaces 10 (p. 378) disponibile su richiesta (min. 20pcs per codice).
Laminated: Special Laminated Surfaces Wood Effect (p. 383) available on demand (min. 20pcs each code).
Special laminated Surfaces Wood Effect (p. 383) disponibile su richiesta (min. 20pcs per codice).
Special Laminated Surfaces Fenix (p. 384) available on demand (min. 20pcs each code).
Special laminated Surfaces Fenix (p. 384) disponibile su richiesta (min. 20pcs per codice).

Steel Top Color / Colore Piano Acciaio

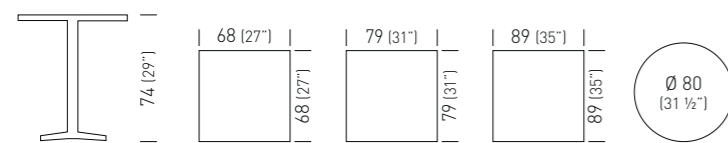
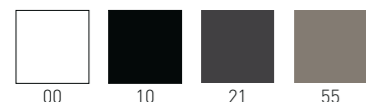

68x68compactop	THUGC200.___/H74		0.17m³ / 15.1kg / 1pc	€	526,00
79x79compactop	THUGC204.___/H74		0.18m³ / 15.6kg / 1pc	€	556,00
89x89compactop	THUGC212.___/H74		0.20m³ / 18.1kg / 1pc	€	652,00
diam.80compactop	THUGC208.___/H74		0.18m³ / 15.1kg / 1pc	€	646,00

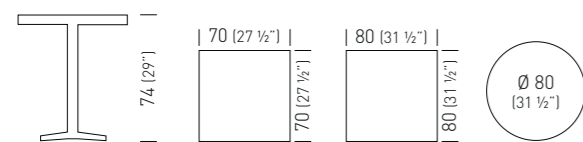

70x70 steel	THUGI217.___/H74		0.17m³ / 15.0kg / 1pc	€	552,00
80x80 steel	THUGI218.___/H74		0.18m³ / 16.0kg / 1pc	€	580,00
diam.80 steel	THUGI219.___/H74		0.18m³ / 13.0kg / 1pc	€	668,00

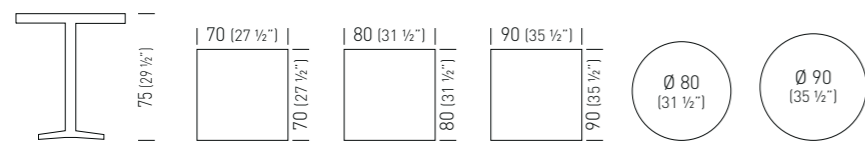

70x70laminated	THUGL220.___/H75		0.17m³ / 15.1kg / 1pc	€	462,00
80x80laminated	THUGL222.___/H75		0.18m³ / 17.6kg / 1pc	€	848,00
90x90laminated	THUGL224.___/H75		0.20m³ / 19.1kg / 1pc	€	528,00
diam.80laminated	THUGL221.___/H75		0.18m³ / 12.6kg / 1pc	€	594,00
diam.90laminated	THUGL223.___/H75		0.20m³ / 13.6kg / 1pc	€	642,00



Only Steel and Compactop
Solo piani Acciaio e Compactop



Hug Marble

Studio Eurolinea Design

The Hug tables collection, made with a 4-star aluminum base, equipped with adjustable feet, is enriched with new Marble tops, thus adapting to the most prestigious installations. The Marble tops, characterized by always different veins of natural stones, contribute to enhance elegance and refinement for the most demanding environments.

The solid Marble surfaces, shiny and glossy, are treated to reduce their porosity, however constant care and cleaning of the product is recommended. La collezione di tavoli Hug, realizzata con basamento 4 razze in alluminio, dotata di piedini regolabili, si arricchisce di nuovi piani quadrati in Marmo, adattandosi così alle installazioni più prestigiose. I piani in Marmo, caratterizzati dalle sempre diverse venature della pietra naturale, offrono eleganza e raffinatezza, per completare con esclusività gli ambienti più ricercati. I solidi piani in Marmo, splendenti e lucidi, sono trattati per ridurre la porosità, tuttavia si consiglia pulizia costante e cura nell'utilizzo del prodotto.

Frame Color / Colore Struttura

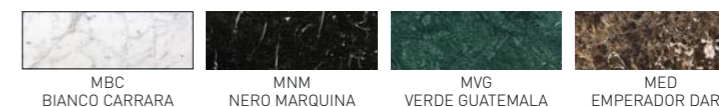
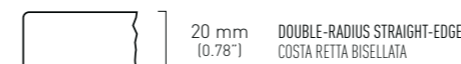
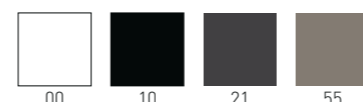

70x70	THUGM215.___/H74		0.34m³ / 31.1kg / 1pc	€	1.030,00
-------	------------------	--	-----------------------	---	-----------------

Hug Porcelain

Studio Eurolinea Design

The Hug tables collection, made with a 4-star aluminum base, equipped with adjustable feet, is enriched with new Porcelain tops, thus adapting to the most prestigious installations. The Porcelain stoneware tops stand out for their excellent technical performance, ideal for the most delicate uses where maximum hygiene and resistance must be guaranteed. Porcelain tops are compatible with foodstuffs, resistant to fungi and molds, suitable for both indoor and outdoor use, resistant to frost, heat and high temperatures, they can be cleaned very easily while maintaining the characteristics of the surface.

La collezione di tavoli Hug, realizzata con basamento 4 razze in alluminio, dotata di piedini regolabili, si arricchisce di nuovi piani quadrati in Gres Porcellanato, adattandosi così alle installazioni più prestigiose. I piani in Gres Porcellanato si distinguono per le eccellenti performance tecniche, ideali negli impieghi più delicati nei quali è necessario garantire la massima igiene e resistenza. I piani Porcelain sono compatibili con le sostanze alimentari, resistenti a funghi e muffe, idonei ad un utilizzo sia interno che esterno, resistenti al gelo, al calore a alle alte temperature, si possono pulire con estrema facilità mantenendo inalterate le caratteristiche della superficie.

Frame Color / Colore Struttura

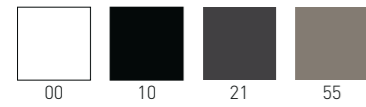

13 mm
(0.51")
CHAMFERED EDGE
BORDO SMUSSATO

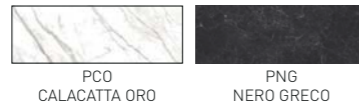

PCO
CALACATTA ORO
PNG
NERO GRECO

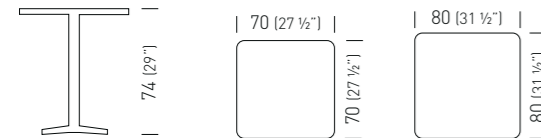

70x70
80x80

THUGP226.____/H74
THUGP227.____/H74



2.4m³ / 32.6kg / 1pc
2.4m³ / 39.1kg / 1pc

€ **1.250,00**
€ **1.294,00**

Min. order 10pcs
each code
Ordine min 10pz
per codice



Frame Color / Colore Struttura

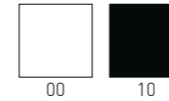

Compact Color / Colore Piano Compactop

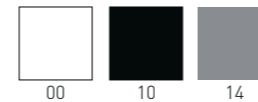

Laminated Top Color / Colore Piano Laminato



Special Finishes / Finiture Speciali

Compactop: Special Compactop Surfaces Fullcolor (p. 377) available on demand (min. 5pcs each code).
Special Compactop Surfaces Fullcolor (p. 377) disponibile su richiesta (min. 5pcs per codice).
Special Compactop Surfaces 10 (p. 378) available on demand (min. 20pcs each code).
Special Compactop Surfaces 10 (p. 378) disponibile su richiesta (min. 20pcs per codice).
Laminated: Special Laminated Surfaces Wood Effect 25 (p. 383) available on demand (min. 20pcs each code).
Special Laminated Surfaces Wood Effect 25 (p. 383) disponibile su richiesta (min. 20pcs per codice).
Special Laminated Surfaces Fenix 25 (p. 384) available on demand (min. 20pcs each code).
Special Laminated Surfaces Fenix 25 (p. 384) disponibile su richiesta (min. 20pcs per codice).

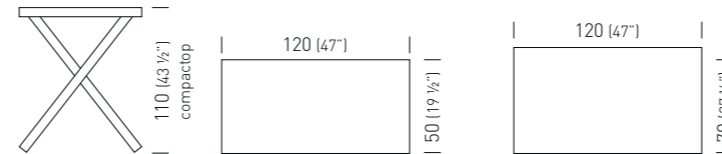

120x50compactop
120x50laminated
120x70compactop
120x70laminated

TICSC830.____/H110
TICSL836.____/H110
TICSC832.____/H110
TICSL838.____/H110



0.47m³ / 25kg / 1pcs
0.47m³ / 25kg / 1pcs
0.48m³ / 26kg / 1pcs
0.48m³ / 26kg / 1pcs

€ **872,00**
€ **682,00**
€ **910,00**
€ **808,00**

Link

Stefano Sandonà Design

Waiting areas and Coffee Table, painted metal structure suitable for outdoor purpose.
Tavolino attesa, struttura in metallo verniciato per utilizzo esterno.



Frame Color / Colore Struttura

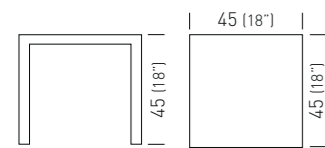
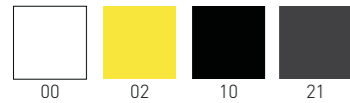

45x45

TLNKI025.../H45

0.18m³ / 7kg / 1pcs

€ **256,00**

Login

Studio Eurolinea Design



Table with co-injected metal frame with techno polymer, wooden legs, Laminated Top.
Tavolo con struttura in metallo sovrastampato con tecnopolimero, gambe in legno massello di faggio o rovere, piani in Laminato.

Frame Color / Colore Struttura

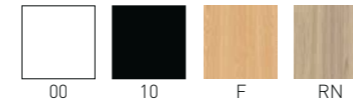

Laminated Top Color / Colore Piano Laminato



Special Finishes / Finiture Speciali

Laminated: Special Laminated Surfaces Wood Effect 25 (p. 383) available on demand (min. 20pcs each code)
Special Laminated Surfaces Wood Effect 25 (p. 383) disponibile su richiesta (min. 20pcs per codice)
Special Laminated Surfaces Fenix 25 (p. 384) available on demand (min. 20pcs each code)
Special Laminated Surfaces Fenix 25 (p. 384) disponibile su richiesta (min. 20pcs per codice)

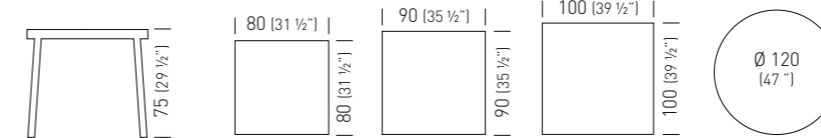

80x80laminated	TLOGL230..._/H75	0.35m³ / 21kg / 1pcs	€ 716,00
90x90laminated	TLOGL232..._/H75	0.46m³ / 22kg / 1pcs	€ 750,00
100x100laminated	TLOGL234..._/H75	0.46m³ / 24kg / 1pcs	€ 822,00
diam. 120laminated	TLOGL236..._/H75	0.80m³ / 26kg / 1pcs	€ 964,00

Lol

Forsix Design

The "Lol" table collection is intended for outdoor use; youthfully simple and sunny, its design blends in discreetly with either the most sparkling or the most sober environments. The table tops with composite material core, as well as the bases, available with three or four spokes, are made up of a metal structure treated for outdoor use, and with a matt finish. The available colour palette is common to many Gaber seating collections, guaranteeing tone-on-tone colour co-ordination throughout designed settings rather than lively contrasts, defining various colour combinations between bases, tops and seating.

La collezione di tavoli Lol, disegnata da Forsix, è ideale per l'utilizzo all'aria aperta: giovane, semplice e solare, il suo design si fonde con discrezione dagli ambienti più sobri a quelli più frizzanti. I piani del tavolo, dal cuore in materiale composito, come anche i basamenti, disponibili a tre o quattro razze, sono costituiti da una struttura in metallo trattata per esterni, dalla finitura opaca. La palette di colori disponibile è comune a molte collezioni di sedute Gaber, garantendo abbinamenti tono su tono degli ambienti progettati, piuttosto che vivaci contrasti, definendo diverse combinazioni di colori tra basi, piani e sedute.

Colours / Colori

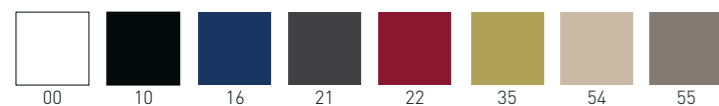

diam.60	TLL3I034._._/H50	0.19m³ / 10.30kg / 1pc	€ 424,00
diam.70	TLL3I036._._/H50	0.19m³ / 10.70kg / 1pc	€ 436,00
diam.60	TLL3I034._._/H75	0.26m³ / 10.90kg / 1pc	€ 432,00
diam.70	TLL3I036._._/H75	0.26m³ / 11.30kg / 1pc	€ 442,00

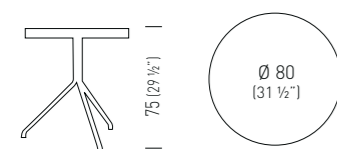

diam.80	TLL3I038._._/H75	0.45m³ / 12.00kg / 1pc	€ 460,00
---------	------------------	------------------------	-----------------

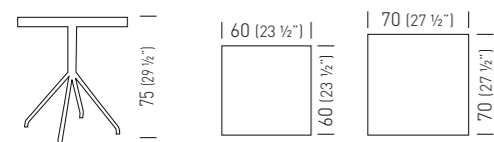

60x60	TLL4I035._._/H75	0.26m³ / 13.00kg / 1pc	€ 434,00
70x70	TLL4I037._._/H75	0.26m³ / 14.60kg / 1pc	€ 444,00

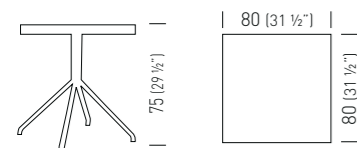

80x80	TLL4I039._._/H75	0.38m³ / 16.30kg / 1pc	€ 474,00
-------	------------------	------------------------	-----------------



Lol Plus

Forsix Design

The Lol Plus tables collection is made of steel, the cross is made in aluminum, and provided with flip-top joint. The shape of the base and the flip-top mechanism allow the table to easily fold and stack, space-saving. The available colour palette is common to many Gaber seating collections, guaranteeing tone-on-tone colour co-ordination throughout designed settings rather than lively contrasts, defining various colour combinations between bases, tops and seating.

La Collezione di tavoli Lol Plus è realizzata in acciaio, la crociera è realizzata in alluminio, ed è dotata di giunto per la rotazione del piano. La forma della base e la meccanica che permette la rotazione del piano in posizione verticale, rendono il tavolo facilmente accatastabile in spazi ridotti. La palette di colori disponibile è comune a molte collezioni di sedute Gaber, garantendo abbinamenti tono su tono degli ambienti progettati, piuttosto che vivaci contrasti, definendo diverse combinazioni di colori tra basi, piani e sedute.

Frame Color / Colore Struttura

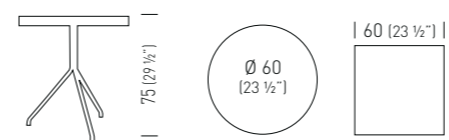
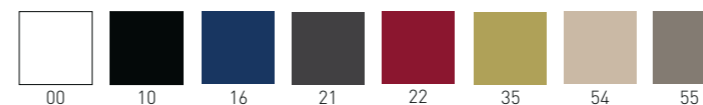

diam.60	TLLPI034._._/H75	0.26m³ / 12.10kg / 1pc	€ 466,00
60x60	TLLPI035._._/H75	0.26m³ / 13.50kg / 1pc	€ 478,00

Lol Marble

Forsix Design

The Lol tables collection is enriched with new Marble tops, with round or square shapes, thus adapting to the most prestigious installations. The Marble tops, characterized by always different veins of natural stones, contribute to enhance elegance and refinement for the most demanding environments. The solid Marble surfaces, shiny and glossy, are treated to reduce their porosity, however constant care and cleaning of the product is recommended. La collezione di tavoli Lol si arricchisce di nuovi piani in Marmo, dalle forme rotonde o quadrate, adattandosi così alle più prestigiose installazioni. I piani in Marmo, caratterizzati dalle sempre diverse venature della pietra naturale, offrono eleganza e raffinatezza, per completare con esclusività gli ambienti più ricercati. I solidi piani in Marmo, splendidi e lucidi, sono trattati per ridurre la porosità, tuttavia si consiglia pulizia costante e cura nell'utilizzo del prodotto.



Lol Porcelain

Forsix Design

The Lol tables collection is enriched with new Porcelain tops, with round or square shapes, thus adapting to the most prestigious installations. The Porcelain stoneware tops stand out for their excellent technical performance, ideal for the most delicate uses where maximum hygiene and resistance must be guaranteed. Porcelain tops are compatible with foodstuffs, resistant to fungi and molds, suitable for both indoor and outdoor use, resistant to frost, heat and high temperatures, they can be cleaned very easily while maintaining the characteristics of the surface.

La collezione di tavoli Lol si arricchisce di nuovi piani in Gres Porcellanato, dalle forme rotonde o quadrate, adattandosi così alle più prestigiose installazioni. I piani in Gres Porcellanato si distinguono per le eccellenti performance tecniche, ideali negli impieghi più delicati nei quali è necessario garantire la massima igiene e resistenza.

I piani Porcelain sono compatibili con le sostanze alimentari, resistenti a funghi e muffe, idonei ad un utilizzo sia interno che esterno, resistenti al gelo, al calore a alle alte temperature, si possono pulire con estrema facilità mantenendo inalterate le caratteristiche della superficie.

Frame Color / Colore Struttura

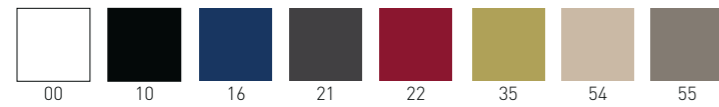

diam.60 TLL3M238._._/H50 0.37m³ / 20kg / 1pc € **762,00**
 diam.70 TLL3M240._._/H50 0.37m³ / 25kg / 1pc € **904,00**

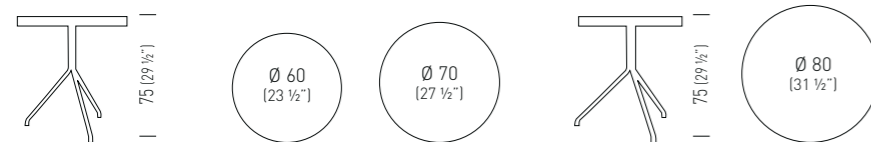

diam.60 TLL3M238._._/H75 0.44m³ / 20.6kg / 1pc € **766,00**
 diam.70 TLL3M240._._/H75 0.44m³ / 25.6kg / 1pc € **908,00**
 diam.80 TLL3M242._._/H75 0.63m³ / 31.7kg / 1pc € **1.086,00**

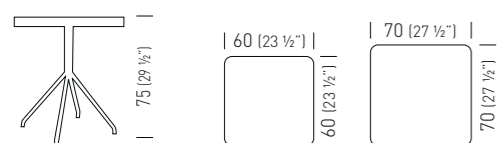

60x60 TLL4M239._._/H75 0.44m³ / 25.5kg / 1pc € **766,00**
 70x70 TLL4M241._._/H75 0.44m³ / 32kg / 1pc € **908,00**

Frame Color / Colore Struttura

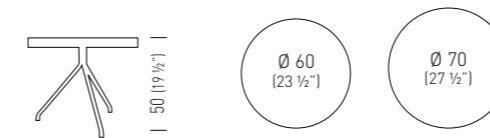
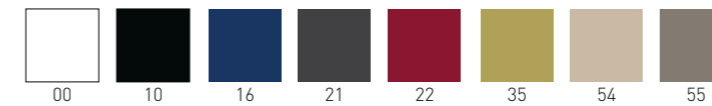

diam.60 TLL3P244._._/H50 0.87m³ / 23.8kg / 1pc € **942,00**
 diam.70 TLL3P246._._/H50 0.87m³ / 27kg / 1pc € **1.120,00**

Min. order 10pcs each code
 Ordine min 10pz per codice

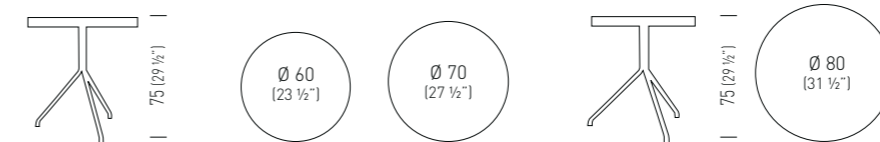

diam.60 TLL3P244._._/H75 0.94m³ / 24.4kg / 1pc € **952,00**
 diam.70 TLL3P246._._/H75 0.94m³ / 27.6kg / 1pc € **1.126,00**
 diam.80 TLL3P248._._/H75 1.13m³ / 32.2kg / 1pc € **1.300,00**

Min. order 10pcs each code
 Ordine min 10pz per codice

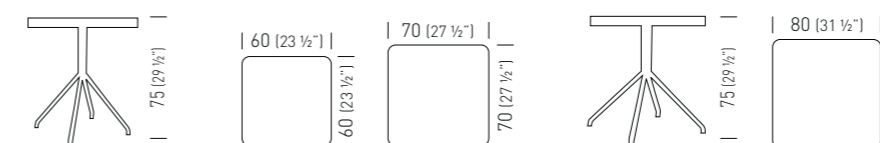

60x60 TLL4P245._._/H75 0.94m³ / 28.5kg / 1pc € **836,00**
 70x70 TLL4P247._._/H75 0.94m³ / 31.5kg / 1pc € **1.150,00**
 80x80 TLL4P249._._/H75 1.05m³ / 29.1kg / 1pc € **1.168,00**

Min. order 10pcs each code
 Ordine min 10pz per codice

Minush

Studio Eurolinea Design

The Minush stackable coffee table, made of technopolymer, takes up the lines of some collections of Gaber chairs and sunbeds, but suit perfectly any outdoor seat as a practical support for small objects.

Il tavolino impilabile Minush, realizzato in tecnopolimero, riprende le linee di alcune collezioni di sedute e lettini Gaber, ma ben si adatta ad accompagnare qualunque seduta da esterno come pratico appoggio per piccoli oggetti.

Technopolymer Frame Color / Colore Struttura Tecnopolimero

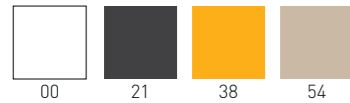

45x45

TMINT024._/H45

0.13m³ / 8kg / 2pcs

€

166,00



230V - 50Hz
1 X 16W - Led Modul
IP 65

Technopolymer Base Color / Colore Base Tecnopolimero

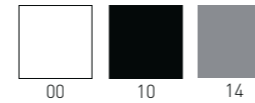

Led version with white transparent base.
Versione led con base in bianco trasparente.

Compactop Color / Colore Piano Compactop

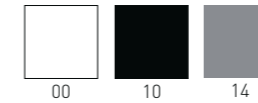

Special Finishes / Finiture Speciali

Compactop: Special Compactop Surfaces Fullcolor (p.377) white available on demand (min. 5pcs each code).
Special Compactop Surfaces Fullcolor (p.377) bianco disponibile su richiesta (min. 5pcs per codice).

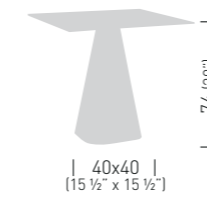

base74
base74 Led
base74+20

Ø 60
(23 1/2'')

diam.68
diam.68 Led
diam.68+20

Ø 80
(31 1/2'')

diam.100
diam.100 Led
diam.100+20

60 (23 1/2'')

60x60
60x60 Led
60x60+20

68 (27'')

68x68
68x68 Led
68x68+20

79 (31'')

79x79
79x79 Led
79x79+20

89 (35'')

89x89
89x89 Led
89x89+20

BMUG._/H74 0.13m³ / 12.5kg / 1pcs € **218,00**
BMUG._/H74L 0.13m³ / 14.7kg / 1pcs € **656,00**
BMUG._/H74+20 0.13m³ / 32.5kg / 1pcs € **268,00**

TMUGC170._-/H74 0.21m³ / 18.0kg / 1pcs € **474,00**
TMUGC170._-/H74L 0.21m³ / 20.2kg / 1pcs € **910,00**
TMUGC170._-/H74+20 0.21m³ / 38.0kg / 1pcs € **524,00**

TMUGC178._-/H74 0.23m³ / 21.5kg / 1pcs € **524,00**
TMUGC178._-/H74L 0.23m³ / 23.7kg / 1pcs € **968,00**
TMUGC178._-/H74+20 0.23m³ / 41.5kg / 1pcs € **574,00**

TMUGC186._-/H74 0.5m³ / 23.5kg / 1pcs € **574,00**
TMUGC186._-/H74L 0.5m³ / 25.7kg / 1pcs € **1.012,00**
TMUGC186._-/H74+20 0.5m³ / 43.5kg / 1pcs € **624,00**

TMUGC198._-/H74 0.67m³ / 28.0kg / 1pcs € **750,00**
TMUGC198._-/H74L 0.67m³ / 32.2kg / 1pcs € **1.106,00**
TMUGC198._-/H74+20 0.67m³ / 48.0kg / 1pcs € **800,00**

TMUGC174._-/H74 0.21m³ / 20.0kg / 1pcs € **420,00**
TMUGC174._-/H74L 0.21m³ / 22.5kg / 1pcs € **860,00**
TMUGC174._-/H74+20 0.21m³ / 39.5kg / 1pcs € **474,00**

TMUGC182._-/H74 0.23m³ / 21.8kg / 1pcs € **454,00**
TMUGC182._-/H74L 0.23m³ / 24.0kg / 1pcs € **888,00**
TMUGC182._-/H74+20 0.23m³ / 41.8kg / 1pcs € **504,00**

TMUGC190._-/H74 0.50m³ / 25.0kg / 1pcs € **484,00**
TMUGC190._-/H74L 0.50m³ / 27.0kg / 1pcs € **922,00**
TMUGC190._-/H74+20 0.50m³ / 45.0kg / 1pcs € **534,00**

TMUGC194._-/H74 0.60m³ / 26.0kg / 1pcs € **630,00**
TMUGC194._-/H74L 0.60m³ / 28.0kg / 1pcs € **1.016,00**
TMUGC194._-/H74+20 0.60m³ / 46.0kg / 1pcs € **680,00**

Mug

Studio Eurolinea Design

H75 Table with Compactop, Technopolymer base. Available illuminated and suitable for outdoor use.

Tavolo realizzato con piano in Compactop H75 e struttura in tecnopolimero. Disponibile con versione luminosa e adatti all'uso esterno.

Norman

Forsix Design

The Norman table collection is made using basic geometries to achieve distinctly shapes. Available with round or square Laminated, Compactop or Marble tops, Norman utilizes a 4 legged aluminum frame, available in many vibrant colours.

La collezione di Tavoli Norman è realizzata utilizzando geometrie semplici e forme essenziali. Disponibile con piani rotondi o quadrati in Laminato, Compactop o Marmo, Norman utilizza una struttura 4 gambe in alluminio, disponibile in vari colori di tendenza.



Only for Compactop and Steel tops
Solo per piani in compactop e acciaio



Frame Color / Colore Struttura

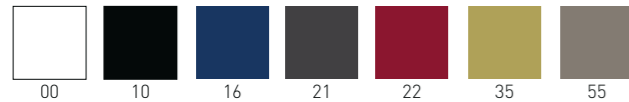

Compactop Color / Colore Piano Compactop

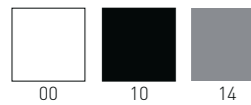

Laminated Top Color / Colore Piano Laminato



Special Finishes / Finiture Speciali

Compactop: Standard Compactop Surfaces 10 (p. 376) available on demand (min. 20pcs each code)
Standard Compactop Surfaces 10 (p. 376) disponibile su richiesta (min. 20pcs per codice)
Special Compactop Surfaces Fullcolor (p.377) white available on demand (min. 5pcs each code).
Special Compactop Surfaces Fullcolor (p.377) bianco disponibile su richiesta (min. 5pcs per codice).

Laminated: Special Laminated Surfaces Wood Effect 25 (p. 383) available on demand (min. 20pcs each code)
Special Laminated Surfaces Wood Effect 25 (p. 383) disponibile su richiesta (min. 20pcs per codice)
Special Laminated Surfaces Fenix 25 (p. 384) available on demand (min. 20pcs each code)
Special Laminated Surfaces Fenix 25 (p. 384) disponibile su richiesta (min. 20pcs per codice)

Steel Top Color / Colori Top Steel

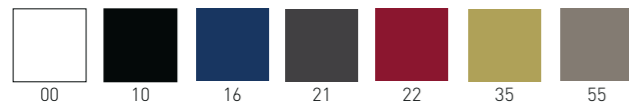

Laminated / Laminato

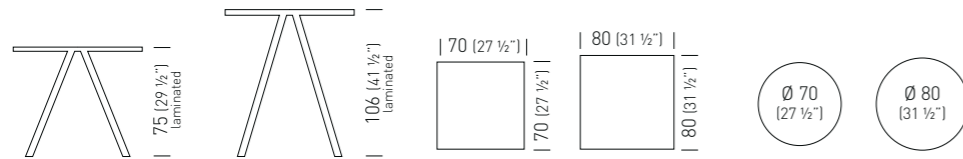

70x70	TNORL481._._/H74	0.20m³ / 16.20kg / 1pc	€ 390,00
80x80	TNORL483._._/H74	0.22m³ / 18.70kg / 1pc	€ 444,00
diam.70	TNORL480._._/H74	0.20m³ / 13.20kg / 1pc	€ 444,00
diam.80	TNORL482._._/H74	0.22m³ / 16.70kg / 1pc	€ 586,00

70x70	TNORL481._._/H105	0.20m³ / 17.34kg / 1pc	€ 434,00
80x80	TNORL483._._/H105	0.22m³ / 19.84kg / 1pc	€ 488,00
diam.70	TNORL480._._/H105	0.20m³ / 14.34kg / 1pc	€ 488,00
diam.80	TNORL482._._/H105	0.22m³ / 17.84kg / 1pc	€ 608,00



Only for Compactop and Steel tops
Solo per piani in compactop e acciaio

Frame Color / Colore Struttura



Compactop Color / Colore Piano Compactop

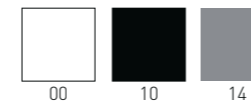

Laminated Top Color / Colore Piano Laminato



Special Finishes / Finiture Speciali

Compactop: Standard Compactop Surfaces 10 (p. 376) available on demand (min. 20pcs each code)
Standard Compactop Surfaces 10 (p. 376) disponibile su richiesta (min. 20pcs per codice)
Special Compactop Surfaces Fullcolor (p.377) white available on demand (min. 5pcs each code).
Special Compactop Surfaces Fullcolor (p.377) bianco disponibile su richiesta (min. 5pcs per codice).

Laminated: Special Laminated Surfaces Wood Effect 25 (p. 383) available on demand (min. 20pcs each code)
Special Laminated Surfaces Wood Effect 25 (p. 383) disponibile su richiesta (min. 20pcs per codice)
Special Laminated Surfaces Fenix 25 (p. 384) available on demand (min. 20pcs each code)
Special Laminated Surfaces Fenix 25 (p. 384) disponibile su richiesta (min. 20pcs per codice)

Steel Top Color / Colori Top Steel



Compactop / Compactop

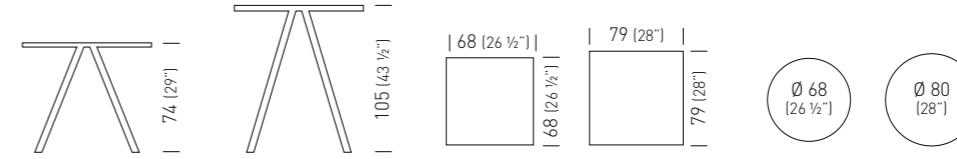

68x68	TNORC472._._/H74	0.20m³ / 16.20kg / 1pc	€ 466,00
79x79	TNORC476._._/H74	0.22m³ / 16.70kg / 1pc	€ 498,00
diam.68	TNORC470._._/H74	0.20m³ / 13.20kg / 1pc	€ 508,00
diam.80	TNORC474._._/H74	0.22m³ / 16.30kg / 1pc	€ 586,00

68x68	TNORC472._._/H105	0.20m³ / 17.34kg / 1pc	€ 510,00
79x79	TNORC476._._/H105	0.22m³ / 17.84kg / 1pc	€ 542,00
diam.68	TNORC470._._/H105	0.20m³ / 14.34kg / 1pc	€ 552,00
diam.80	TNORC474._._/H105	0.22m³ / 17.44kg / 1pc	€ 630,00

Steel / Acciaio

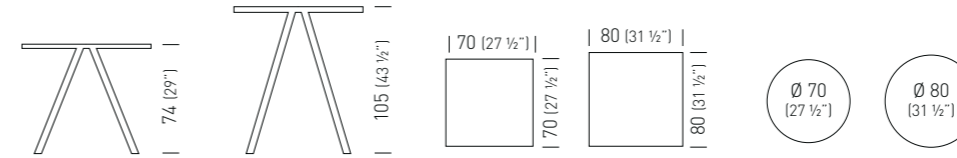

70x70	TNORI486._._/H74	0.20m³ / 19.20kg / 1pc	€ 508,00
80x80	TNORI488._._/H74	0.22m³ / 20.20kg / 1pc	€ 652,00
diam.70	TNORI485._._/H74	0.20m³ / 16.20kg / 1pc	€ 502,00
diam.80	TNORI487._._/H74	0.22m³ / 21.20kg / 1pc	€ 638,00

70x70	TNORI486._._/H105	0.20m³ / 20.34kg / 1pc	€ 552,00
80x80	TNORI488._._/H105	0.22m³ / 21.34kg / 1pc	€ 696,00
diam.70	TNORI485._._/H105	0.20m³ / 17.34kg / 1pc	€ 546,00
diam.80	TNORI487._._/H105	0.22m³ / 22.34kg / 1pc	€ 682,00

Norman

Forsix Design

Norman Marble

Forsix Design

The Norman table collection utilizes a 4 legged aluminum frame, available in many vibrant colours. The Marble tops, characterized by always different veins of natural stones, contribute to enhance elegance and refinement for the most demanding environments. The solid Marble surfaces, shiny and glossy, are treated to reduce their porosity, however constant care and cleaning of the product is recommended.

La collezione di Tavoli Norman utilizza una struttura 4 gambe in alluminio, disponibile in vari colori di tendenza. I piani in Marmo, caratterizzati dalle sempre diverse venature della pietra naturale, offrono eleganza e raffinatezza, per completare con esclusività gli ambienti più ricercati. I solidi piani in Marmo, splendidi e lucidi, sono trattati per ridurre la porosità, tuttavia si consiglia pulizia costante e cura nell'utilizzo del prodotto.



Frame Color / Colore Struttura

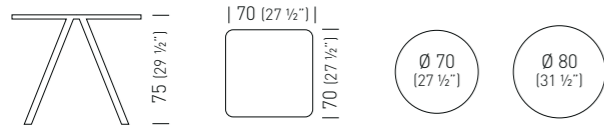
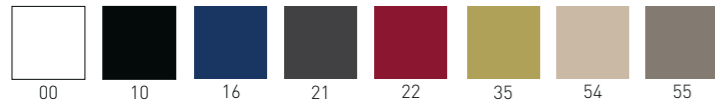

70x70	TNORM491__-_/H75	0.34m³ / 30.20kg / 1pc	€ 852,00
diam.70	TNORM490__-_/H75	0.34m³ / 24.70kg / 1pc	€ 852,00
diam.80	TNORM492__-_/H75	0.34m³ / 30.70kg / 1pc	€ 976,00

Pareo

Forsix Design

The Pareo Collection offers a wide range of beautifully designed dining and coffee tables. Thanks to their clean yet detailed design, Pareo tables suit a variety of hospitality settings, available in square, rectangular and round versions. The aluminum table frame, combined with Compact or Porcelain table tops, fits perfectly into even outdoor environments. Pareo Tables are made to be easily assembled and are available in a wide variety of bright frame colours and top finishes, perfectly matching your custom projects.

La collezione Pareo offre una vasta gamma di tavoli e tavolini dal design accattivante. Grazie alle loro linee essenziali e curate, i tavoli Pareo si adattano a diversi stili dedicati all'ospitalità e sono disponibili nella versione quadrata, rettangolare o rotonda. La struttura del tavolo, realizzata in alluminio, abbinata ai piani in Compactop o Gres, si adatta perfettamente anche agli ambienti esterni. I tavoli Pareo sono realizzati per essere facilmente e velocemente assemblati e sono disponibili in un'ampia varietà di colori e finiture, perfetti per i vostri progetti personalizzati.



Frame Color / Colore Struttura

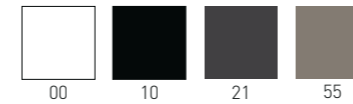

Compactop Color / Colore Piano Compactop

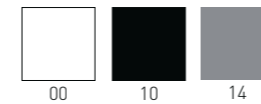

Special Finishes / Finiture Speciali

Compactop: Special Compactop Surfaces Fullcolor (p. 377) available on demand (min. 5pcs each code).
Special Compactop Surfaces Fullcolor (p. 377) disponibile su richiesta (min. 5pcs per codice).
Special Compactop Surfaces 10 (p. 378) available on demand (min. 20pcs each code).
Special Compactop Surfaces 10 (p. 378) disponibile su richiesta (min. 20pcs per codice).

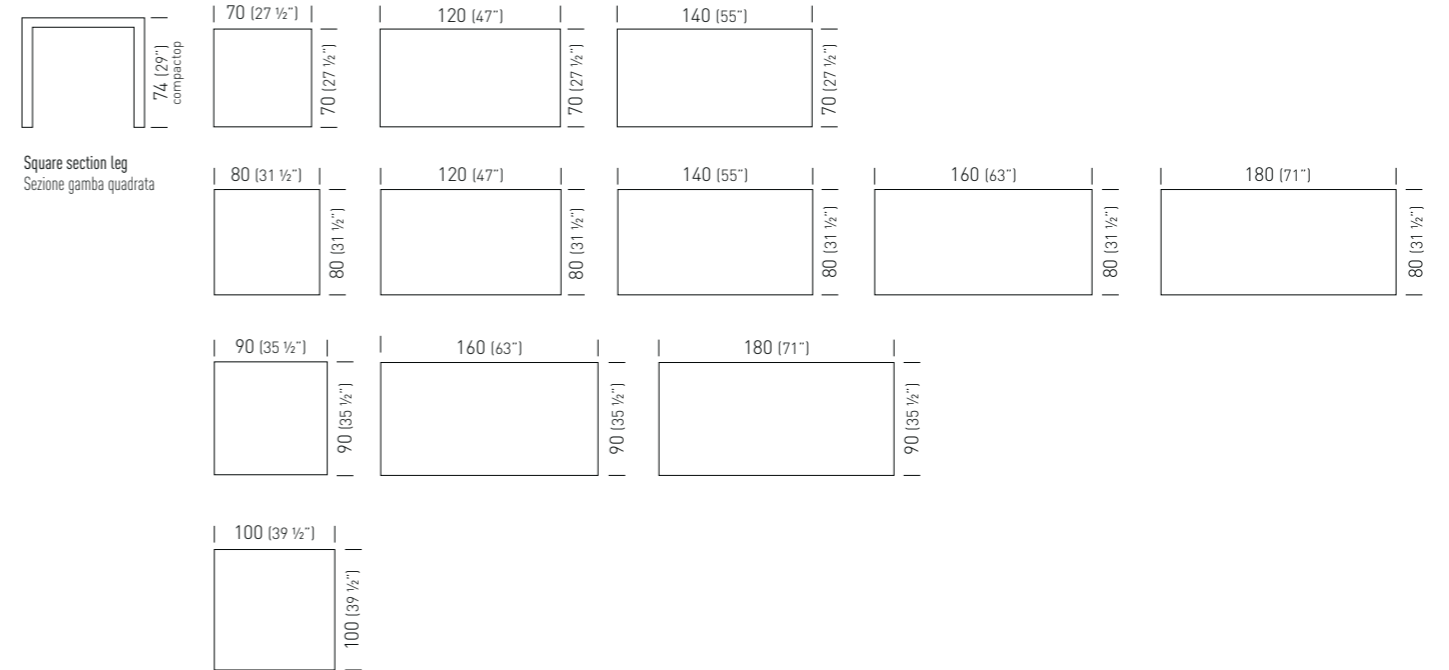

70x70compactop	TPAQC700__-_/H74	0.09m³ / 19.30kg / 1pc	€ 490,00
80x80compactop	TPAQC708__-_/H74	0.10m³ / 19.80kg / 1pc	€ 564,00
90x90compactop	TPAQC718__-_/H74	0.16m³ / 22.30kg / 1pc	€ 650,00
100x100compactop	TPAQC728__-_/H74	0.19m³ / 26.30kg / 1pc	€ 738,00
120x70compactop	TPAQC702__-_/H74	0.29m³ / 36.80kg / 1pc	€ 738,00
120x80compactop	TPAQC710__-_/H74	0.29m³ / 39.30kg / 1pc	€ 786,00
140x70compactop	TPAQC704__-_/H74	0.29m³ / 41.80kg / 1pc	€ 940,00
140x80compactop	TPAQC712__-_/H74	0.29m³ / 43.10kg / 1pc	€ 1.012,00
160x80compactop	TPAQC714__-_/H74	0.30m³ / 45.80kg / 1pc	€ 1.234,00
160x90compactop	TPAQC724__-_/H74	0.30m³ / 48.80kg / 1pc	€ 1.332,00
180x80compactop	TPAQC716__-_/H74	0.30m³ / 48.80kg / 1pc	€ 1.326,00
180x90compactop	TPAQC726__-_/H74	0.30m³ / 51.80kg / 1pc	€ 1.448,00

The Pareo Collection offers a wide range of beautifully designed dining and coffee tables. Thanks to their clean yet detailed design, Pareo tables suit a variety of hospitality settings, available in square, rectangular and round versions. The aluminum table frame, combined with Compact or Porcelain table tops, fits perfectly into even outdoor environments. Pareo Tables are made to be easily assembled and are available in a wide variety of bright frame colours and top finishes, perfectly matching your custom projects.

La collezione Pareo offre una vasta gamma di tavoli e tavolini dal design accattivante. Grazie alle loro linee essenziali e curate, i tavoli Pareo si adattano a diversi stili dedicati all'ospitalità e sono disponibili nella versione quadrata, rettangolare o rotonda. La struttura del tavolo, realizzata in alluminio, abbinata ai piani in Compactop o Gres, si adatta perfettamente anche agli ambienti esterni. I tavoli Pareo sono realizzati per essere facilmente e velocemente assemblati e sono disponibili in un'ampia varietà di colori e finiture, perfetti per i vostri progetti personalizzati.

Frame Color / Colore Struttura

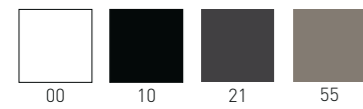

Laminated Top Color / Colore Piano Laminato



Special Finishes / Finiture Speciali

Laminated: Special Laminated Surfaces Wood Effect 25 (p. 383) available on demand (min. 20pcs each code)
 Special Laminated Surfaces Wood Effect 25 (p. 383) disponibile su richiesta (min. 20pcs per codice)
 Special Laminated Surfaces Fenix 25 (p. 384) available on demand (min. 20pcs each code)
 Special Laminated Surfaces Fenix 25 (p. 384) disponibile su richiesta (min. 20pcs per codice)

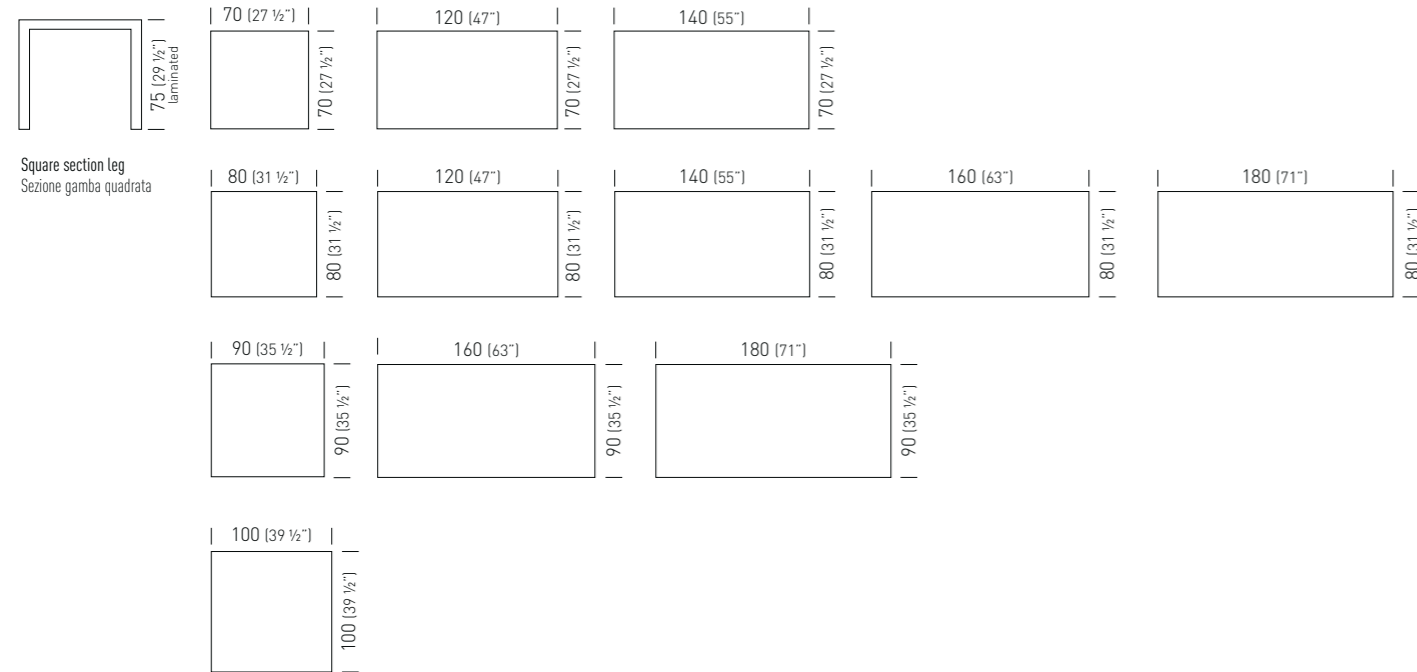

70x70laminated	TPAQL740._._/H74		0.09m³ / 19.30kg / 1pc	€	446,00
80x80laminated	TPAQL744._._/H74		0.10m³ / 21.80kg / 1pc	€	520,00
90x90laminated	TPAQL749._._/H74		0.16m³ / 23.30kg / 1pc	€	606,00
100x100laminated	TPAQL754._._/H74		0.19m³ / 23.80kg / 1pc	€	694,00
120x70laminated	TPAQL741._._/H74		0.30m³ / 35kg / 1pc	€	668,00
120x80laminated	TPAQL745._._/H74		0.30m³ / 37.80kg / 1pc	€	742,00
140x70laminated	TPAQL742._._/H74		0.31m³ / 39.80kg / 1pc	€	896,00
140x80laminated	TPAQL746._._/H74		0.31m³ / 39.80kg / 1pc	€	968,00
160x80laminated	TPAQL747._._/H74		0.31m³ / 40.80kg / 1pc	€	1.190,00
160x90laminated	TPAQL752._._/H74		0.31m³ / 42.80kg / 1pc	€	1.286,00
180x80laminated	TPAQL748._._/H74		0.32m³ / 42.80kg / 1pc	€	1.282,00
180x90laminated	TPAQL753._._/H74		0.32m³ / 45.30kg / 1pc	€	1.404,00



Only for compactop
solo per compactop

Frame Color / Colore Struttura

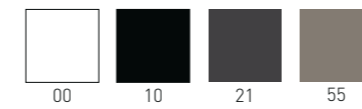

Compactop Color / Colore Piano Compactop

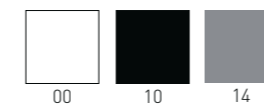

Laminated Top Color / Colore Piano Laminato



Special Finishes / Finiture Speciali

Compactop: Special Compactop Surfaces Fullcolor (p. 377) available on demand (min. 5pcs each code).
 Special Compactop Surfaces Fullcolor (p. 377) disponibile su richiesta (min. 5pcs per codice).
 Special Compactop Surfaces 10 (p. 378) available on demand (min. 20pcs each code).
 Special Compactop Surfaces 10 (p. 378) disponibile su richiesta (min. 20pcs per codice).

Laminated: Special Laminated Surfaces Wood Effect 25 (p. 383) available on demand (min. 20pcs each code)
 Special Laminated Surfaces Wood Effect 25 (p. 383) disponibile su richiesta (min. 20pcs per codice)
 Special Laminated Surfaces Fenix 25 (p. 384) available on demand (min. 20pcs each code)
 Special Laminated Surfaces Fenix 25 (p. 384) disponibile su richiesta (min. 20pcs per codice)

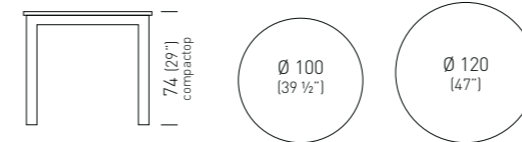

diam.100compactop	TPARC730._._/H74		0.30m³ / 38.30kg / 1pc	€	770,00
diam.120compactop	TPARC732._._/H74		0.30m³ / 43.80kg / 1pc	€	836,00
diam.100laminated	TPARL755._._/H74		0.28m³ / 32.80kg / 1pc	€	726,00
diam.120laminated	TPARL756._._/H74		0.29m³ / 36.30kg / 1pc	€	792,00

Pareo Marble

Forsix Design

The Pareo Marble tables utilizes a resistant aluminum and steel frame, fast and easy to assemble. The Marble tops, characterized by always different veins of natural stones, contribute to enhance elegance and refinement for the most demanding environments. The solid Marble surfaces, shiny and glossy, are treated to reduce their porosity, however constant care and cleaning of the product is recommended.

La collezione tavoli Pareo Marble utilizza un resistente telaio in alluminio e acciaio, facile ed intuitivo nell'assemblaggio. I piani in Marmo, caratterizzati dalle sempre diverse venature della pietra naturale, offrono eleganza e raffinatezza, per completare con esclusività gli ambienti più ricercati. I solidi piani in Marmo, splendenti e lucidi, sono trattati per ridurne la porosità, tuttavia si consiglia pulizia costante e cura nell'utilizzo del prodotto.



Pareo Porcelain

Forsix Design

The Pareo Porcelain tables utilizes a resistant aluminum and steel frame, fast and easy to assemble. The Porcelain stoneware tops stand out for their excellent technical performance, ideal for the most delicate uses where maximum hygiene and resistance must be guaranteed. Porcelain tops are compatible with foodstuffs, resistant to fungi and molds, suitable for both indoor and outdoor use, resistant to frost, heat and high temperatures, they can be cleaned very easily while maintaining the characteristics of the surface.

La collezione tavoli Pareo Porcelain utilizza un resistente telaio in alluminio e acciaio, facile ed intuitivo nell'assemblaggio. I piani in Gres Porcellanato si distinguono per le eccellenti performance tecniche, ideali negli impieghi più delicati nei quali è necessario garantire la massima igiene e resistenza. I piani Porcelain sono compatibili con le sostanze alimentari, resistenti a funghi e muffe, ideali ad un utilizzo sia interno che esterno, resistenti al gelo, al calore alle alte temperature, si possono pulire con estrema facilità mantenendo inalterate le caratteristiche della superficie.

Frame Color / Colore Struttura

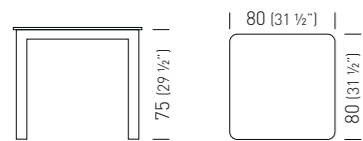
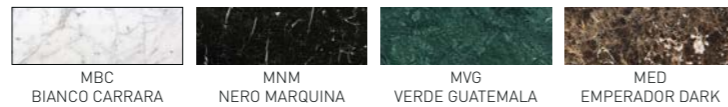
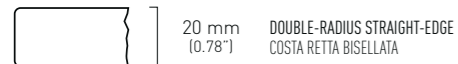
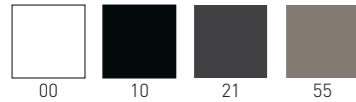

Round section leg
Sezione gamba rotonda

80x80 TPARM760._._/H74 0.97m³ / 57.80kg / 1pc € 1.056,00

Frame Color / Colore Struttura

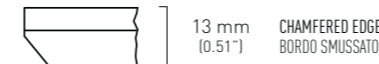
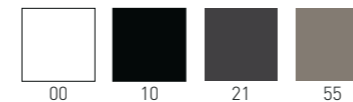

Round section leg
Sezione gamba rotonda



Round section leg
Sezione gamba rotonda

80x80 TPARP766._._/H74 0.27m³ / 37.70kg / 1pc € 1.320,00
160x80 TPARP768._._/H74 0.30m³ / 47.40kg / 1pc € 2.420,00

Min. order 10pcs
each code
Ordine min 10pz
per codice

Profilo

Studio Eurolinea Design

Compactop or Laminated table top with painted metal frame. Adjustable feet.
Tavolo con struttura in metallo verniciato, piano in Compactop o Laminato. Piedini regolabili



Frame Color / Colore Struttura



00

Compactop Color / Colore Piano Compactop



00



10



14

Laminated Top Color / Colore Piano Laminato



00



10



F



W



RN

Special Finishes / Finiture Speciali

Compactop: Special Compactop Surfaces Fullcolor (p. 377) available on demand (min. 5pcs each code).
Special Compactop Surfaces Fullcolor (p. 377) disponibile su richiesta (min. 5pcs per codice).
Special Compactop Surfaces 10 (p. 378) available on demand (min. 20pcs each code).
Special Compactop Surfaces 10 (p. 378) disponibile su richiesta (min. 20pcs per codice).
Laminated: Special Laminated Surfaces Wood Effect 25 (p. 383) available on demand (min. 20pcs each code).
Special Laminated Surfaces Wood Effect 25 (p. 383) disponibile su richiesta (min. 20pcs per codice).
Special Laminated Surfaces Fenix 25 (p. 384) available on demand (min. 20pcs each code).
Special Laminated Surfaces Fenix 25 (p. 384) disponibile su richiesta (min. 20pcs per codice).

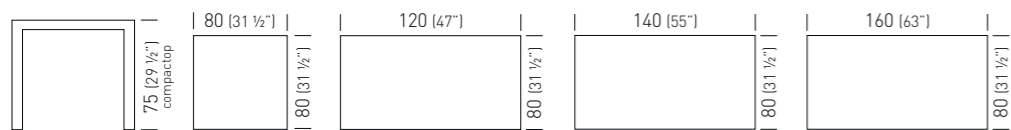

80x80compactop	TPROC500. _-_/H75		0.32m ³ / 24kg / 1pcs	€	726,00
80x80laminated	TPROL518. _-_/H75		0.32m ³ / 24kg / 1pcs	€	606,00
80x120compactop	TPROC502. _-_/H75		0.43m ³ / 29kg / 1pcs	€	1.016,00
80x120laminated	TPROL520. _-_/H75		0.43m ³ / 29kg / 1pcs	€	724,00
80x140compactop	TPROC504. _-_/H75		0.48m ³ / 33kg / 1pcs	€	1.062,00
80x140laminated	TPROL522. _-_/H75		0.48m ³ / 33kg / 1pcs	€	792,00
80x160compactop	TPROC506. _-_/H75		0.53m ³ / 38kg / 1pcs	€	1.118,00
80x160laminated	TPROL524. _-_/H75		0.53m ³ / 38kg / 1pcs	€	854,00

Roller

Studio Eurolinea Design

Tables, chairs, benches and stools Collection.
Compactop with technopolymer bases.
Available illuminated and suitable for outdoor use.
Collezione di tavoli, sedute, panche e sgabelli.
I tavoli sono realizzati con piano Compactop e struttura in tecnopolimero.
Disponibili con versione luminosa e adatti anche all'uso esterno.



Technopolymer Base Color / Colore Base Tecnopolimero



00

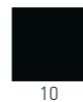

10



13



14

Compactop Color / Colore Piano Compactop



00



10



14

Special Finishes / Finiture Speciali

Compactop: Special Compactop Surfaces Fullcolor (p.377) white available on demand (min. 5pcs each code).
Special Compactop Surfaces Fullcolor (p.377) bianco disponibile su richiesta (min. 5pcs per codice).

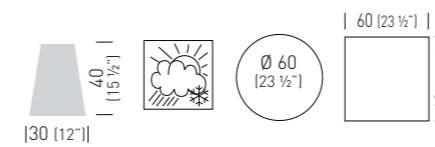

base	BROLLER. _-_/H40		0.11m ³ / 2,5kg / 1pcs	€	172,00
diam.60	TROLC040. _-_/H40		0.18m ³ / 8kg / 1pcs	€	426,00
60x60	TROLC044. _-_/H40		0.18m ³ / 11,8kg / 1pcs	€	376,00



Technopolymer Base Color / Colore Base Tecnopolimero



00

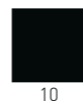

10



13



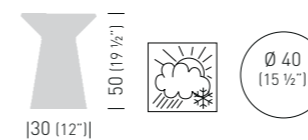

14



tavolino	244.--/A		0.1m ³ / 4kg / 1pcs	€	222,00
----------	----------	--	--------------------------------	---	---------------





CE  
 230V - 50Hz
 1 X 16W - Led Modul
 IP 65

Technopolymer Base Color / Colore Base Tecnopolimero

Compact Color / Colore Piano Compacto



Special Finishes / Finiture Speciali

Compacto: Special Compacto Surfaces Fullcolor (p.377) white available on demand (min. 5pcs each code). Special Compacto Surfaces Fullcolor (p.377) bianco disponibile su richiesta (min. 5pcs per codice).

Led version with white transparent base.
 Versione led con base in bianco trasparente.

base55	BROLLER_/H55	 0.13m³ / 9.8kg / 1pcs	€ 198,00
base55 Led	BROLLER_/H55L	 0.13m³ / 13kg / 1pcs	€ 636,00
Ø 60 [23 1/2"]	diam.60	TROLC040.__/H55  0.21m³ / 15.5kg / 1pcs	€ 454,00
	diam.60 Led	TROLC040.__/H55L  0.21m³ / 18.8kg / 1pcs	€ 892,00
Ø 68 [27"]	diam.68	TROLC048.__/H55  0.23m³ / 19kg / 1pcs	€ 504,00
	diam.68 Led	TROLC048.__/H55L  0.23m³ / 22.2kg / 1pcs	€ 942,00
60x60 [23 1/2"]	60x60	TROLC044.__/H55  0.21m³ / 17.5kg / 1pcs	€ 402,00
	60x60 Led	TROLC044.__/H55L  0.21m³ / 20.7kg / 1pcs	€ 840,00
68x68 [27"]	68x68	TROLC052.__/H55  0.23m³ / 20.5kg / 1pcs	€ 434,00
	68x68 Led	TROLC052.__/H55L  0.23m³ / 23.7kg / 1pcs	€ 870,00



CE  
 230V - 50Hz
 1 X 16W - Led Modul
 IP 65



















Technopolymer Base Color / Colore Base Tecnopolimero

Compact Color / Colore Piano Compacto



Special Finishes / Finiture Speciali

Compacto: Special Compacto Surfaces Fullcolor (p.377) white available on demand (min. 5pcs each code). Special Compacto Surfaces Fullcolor (p.377) bianco disponibile su richiesta (min. 5pcs per codice).



Led version with white transparent base.
 Versione led con base in bianco trasparente.

base74	BROLLER_/H74	 0.13m³ / 11.30kg / 1pcs	€ 248,00
base74+20	BROLLER_/H74+20	 0.13m³ / 31.30kg / 1pcs	€ 300,00
base74 Led	BROLLER_/H74L	 0.13m³ / 14.45kg / 1pcs	€ 686,00
Ø 60 [23 1/2"]	diam.60	TROLC040.__/H74  0.21m³ / 16.8kg / 1pcs	€ 504,00
	diam.60 Led	TROLC040.__/H74L  0.21m³ / 19.9kg / 1pcs	€ 942,00
Ø 68 [27"]	diam.68	TROLC048.__/H74  0.23m³ / 20.3kg / 1pcs	€ 554,00
	diam.68 Led	TROLC048.__/H74L  0.23m³ / 23.4kg / 1pcs	€ 992,00
Ø 80 [31 1/2"]	diam.80	TROLC056.__/H74  0.5m³ / 22.3kg / 1pcs	€ 606,00
	diam.80 Led	TROLC056.__/H74L  0.5m³ / 25.5kg / 1pcs	€ 1.042,00
Ø 100 [39 1/2"]	diam.100	TROLC068.__/H74  0.67m³ / 27kg / 1pcs	€ 782,00
	diam.100 Led	TROLC068.__/H74L  0.67m³ / 30kg / 1pcs	€ 1.218,00
60x60 [23 1/2"]	60x60	TROLC044.__/H74  0.21m³ / 19.5kg / 1pcs	€ 454,00
	60x60 Led	TROLC044.__/H74L  0.21m³ / 22.5kg / 1pcs	€ 892,00
68x68 [27"]	68x68	TROLC052.__/H74  0.23m³ / 21.8kg / 1pcs	€ 484,00
	68x68 Led	TROLC052.__/H74L  0.23m³ / 25kg / 1pcs	€ 922,00
79x79 [31"]	79x79	TROLC060.__/H74  0.50m³ / 23.8kg / 1pcs	€ 514,00
	79x79 Led	TROLC060.__/H74L  0.50m³ / 27kg / 1pcs	€ 952,00
89x89 [35"]	89x89	TROLC064.__/H74  0.60m³ / 24.8kg / 1pcs	€ 660,00
	89x89 Led	TROLC064.__/H74L  0.60m³ / 27.9kg / 1pcs	€ 1.098,00

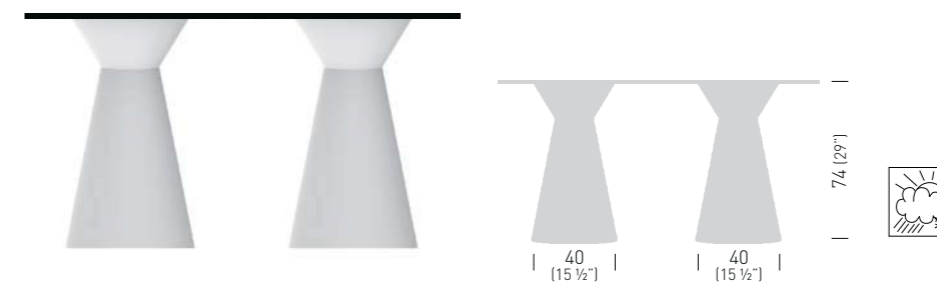

CE  
 230V - 50Hz
 1 X 16W - Led Modul
 IP 65



CE  
 230V - 50Hz
 1 X 16W - Led Modul
 IP 65

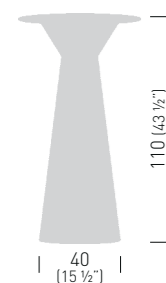

Technopolymer Base Color / Colore Base Tecnopolimero

Compactop Color / Colore Piano Compactop

Special Finishes / Finiture Speciali

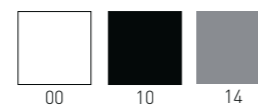
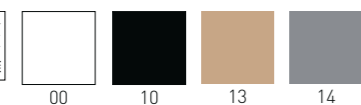

Compactop: Special Compactop Surfaces Fullcolor (p.377) white available on demand (min. 5pcs each code).
 Special Compactop Surfaces Fullcolor (p.377) bianco disponibile su richiesta (min. 5pcs per codice).

Led version with white transparent base.
 Versione led con base in bianco trasparente.

Technopolymer Base Color / Colore Base Tecnopolimero



Compactop Color / Colore Piano Compactop

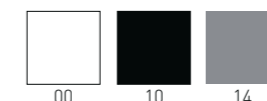

Special Finishes / Finiture Speciali







Compactop: Special Compactop Surfaces Fullcolor (p.377) white available on demand (min. 5pcs each code).
 Special Compactop Surfaces Fullcolor (p.377) bianco disponibile su richiesta (min. 5pcs per codice).



Led version with white transparent base.
 Versione led con base in bianco trasparente.



base110	BROLLER._/H110	 0.2m ³ / 11.30kg / 1pcs	€ 376,00
base110+20	BROLLER._/H110+20	 0.2m ³ / 31.30kg / 1pcs	€ 426,00
base110 Led	BROLLER._/H110L	 0.2m ³ / 14.45kg / 1pcs	€ 814,00



Ø 60 (23 1/2")	diam.60	TROLC040._/_/H110	 0.28m ³ / 20.6kg / 1pcs	€ 630,00
	diam.60 Led	TROLC040._/_/H110L	 0.28m ³ / 23.8kg / 1pcs	€ 1.062,00

Ø 68 (27")	diam.68	TROLC048._/_/H110	 0.31m ³ / 24.1kg / 1pcs	€ 680,00
	diam.68 Led	TROLC048._/_/H110L	 0.31m ³ / 27.3kg / 1pcs	€ 1.112,00

Ø 80 (31 1/2")	diam.80	TROLC056._/_/H110	 0.5m ³ / 26.1kg / 1pcs	€ 730,00
	diam.80 Led	TROLC056._/_/H110L	 0.5m ³ / 29.3kg / 1pcs	€ 1.162,00

60 (23 1/2")	60x60	TROLC044._/_/H110	 0.28m ³ / 22.8kg / 1pcs	€ 578,00
	60x60 Led	TROLC044._/_/H110L	 0.28m ³ / 26kg / 1pcs	€ 1.016,00

68 (27")	68x68	TROLC052._/_/H110	 0.31m ³ / 25.6kg / 1pcs	€ 610,00
	68x68 Led	TROLC052._/_/H110L	 0.31m ³ / 28.8kg / 1pcs	€ 1.046,00

79 (31")	79x79	TROLC060._/_/H110	 0.5m ³ / 27.6kg / 1pcs	€ 644,00
	79x79 Led	TROLC060._/_/H110L	 0.5m ³ / 30.8kg / 1pcs	€ 1.082,00

120 (47")	base74	BROLLER._/2H74	 0.26m ³ / 22.60kg / 1pcs	€ 500,00
-----------	--------	----------------	--	-----------------

120 (47")	120x50	TROLC072._/_/2H74	 0.56m ³ / 38.1kg / 1pcs	€ 1.002,00
-----------	--------	-------------------	--	-------------------

120 (47")	120x80	TROLC076._/_/2H74	 0.56m ³ / 39.1kg / 1pcs	€ 1.008,00
-----------	--------	-------------------	--	-------------------

140 (55")	140x70	TROLC080._/_/2H74	 0.66m ³ / 42.6kg / 1pcs	€ 1.018,00
-----------	--------	-------------------	--	-------------------

159 (62 1/2")	159x79	TROLC084._/_/2H74	 0.94m ³ / 45.6kg / 1pcs	€ 1.078,00
---------------	--------	-------------------	--	-------------------

120 (47")	base110	BROLLER._/2H110	 0.38m ³ / 30.2kg / 1pcs	€ 752,00
-----------	---------	-----------------	--	-----------------

120 (47")	120x50	TROLC072._/_/H110	 0.66m ³ / 45.7kg / 1pcs	€ 1.254,00
-----------	--------	-------------------	--	-------------------

120 (47")	120x80	TROLC076._/_/H110	 0.66m ³ / 46.7kg / 1pcs	€ 1.260,00
-----------	--------	-------------------	--	-------------------

140 (55")	140x70	TROLC080._/_/H110	 0.84m ³ / 50.2kg / 1pcs	€ 1.274,00
-----------	--------	-------------------	--	-------------------

159 (62 1/2")	159x79	TROLC084._/_/H110	 1.04m ³ / 53.2kg / 1pcs	€ 1.332,00
---------------	--------	-------------------	--	-------------------

Saturno

Studio Eurolinea Design

Compactop with painted aluminum frame.
Tavolo con piano Compactop e struttura in alluminio verniciato.



Base Color / Colore Base



00

Top Color / Colore Piano



00



10



14

Special Finishes / Finiture Speciali

Compactop: Special Compactop Surfaces Fullcolor (p. 377) available on demand (min. 5pcs each code).
Special Compactop Surfaces Fullcolor (p. 377) disponibile su richiesta (min. 5pcs per codice).
Special Compactop Surfaces 10 (p. 378) available on demand (min. 20pcs each code).
Special Compactop Surfaces 10 (p. 378) disponibile su richiesta (min. 20pcs per codice).

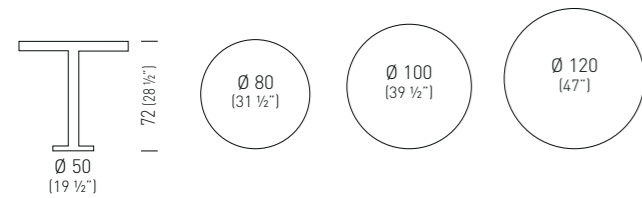

diam.80	TSATC142.___/H72	0.56m³ / 28kg / 1pcs	€ 1.600,00
diam.100	TSATC146.___/H72	0.74m³ / 30kg / 1pcs	€ 1.870,00
diam.120	TSATC150.___/H72	0.87m³ / 33kg / 1pcs	€ 2.178,00

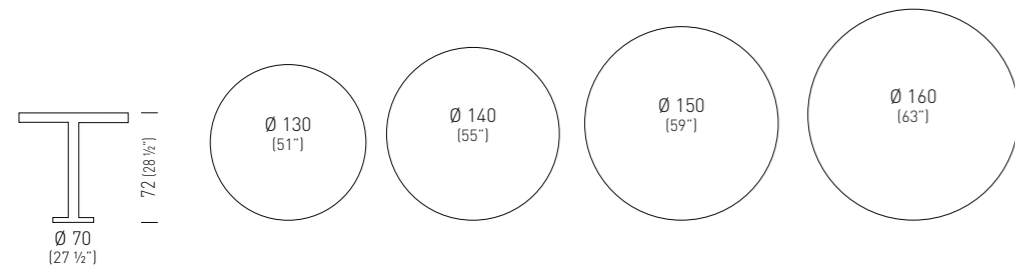

diam.130	TSATC153.___/H72	0.90m³ / 50kg / 1pcs	€ 2.416,00
diam.140	TSATC156.___/H72	0.90m³ / 53kg / 1pcs	€ 2.592,00
diam.150	TSATC159.___/H72	0.90m³ / 56kg / 1pcs	€ 2.924,00
diam.160	TSATC162.___/H72	1.10m³ / 59kg / 1pcs	€ 3.432,00

Saturnino

Studio Eurolinea Design

Waiting areas and Coffee Table,
Compactop with painted aluminum frame.
Tavolino attesa con piano Compactop e struttura in alluminio verniciato.



Base Color / Colore Base

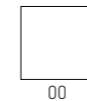

00

Top Color / Colore Piano

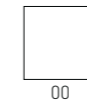

00

Fullcolor

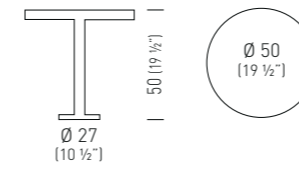

diam.50	TSATC140.___/H50	0.3m³ / 10kg / 1pcs	€ 798,00
---------	------------------	---------------------	-----------------

Stackable table with laminated or Iron top and painted metal frame.

Tavolo impilabile con piano in laminato o Iron e telaio in metallo verniciato.



Only Iron Top
Solo Iron top



Frame Color / Colore Struttura Iron Top Color / Colore Piano Iron

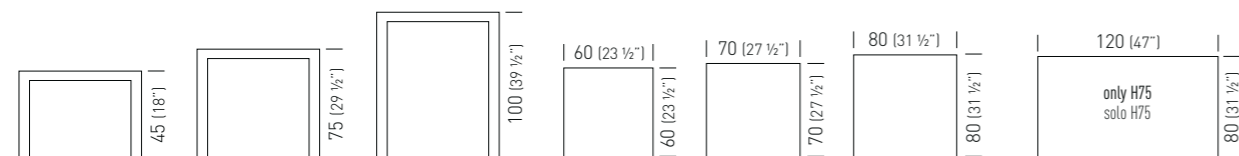

60x60	TSIMI430._._/H45		0.28m³ / 17.0kg / 1pcs	€	484,00
60x60	TSIMI430._._/H75		0.28m³ / 17.5kg / 1pcs	€	484,00
60x60	TSIMI430._._/H100		0.28m³ / 18.5kg / 1pcs	€	546,00
70x70	TSIMI432._._/H45		0.28m³ / 18.0kg / 1pcs	€	500,00
70x70	TSIMI432._._/H75		0.28m³ / 18.5kg / 1pcs	€	500,00
70x70	TSIMI432._._/H100		0.28m³ / 19.5kg / 1pcs	€	556,00
80x80	TSIMI434._._/H45		0.40m³ / 19.0kg / 1pcs	€	526,00
80x80	TSIMI434._._/H75		0.40m³ / 19.5kg / 1pcs	€	526,00
80x80	TSIMI434._._/H100		0.40m³ / 20.5kg / 1pcs	€	584,00
120x80	TSIMI436._._/H75		0.40m³ / 25.0kg / 1pcs	€	732,00

Frame Color / Colore Struttura Laminated Top Color / Colore Piano Laminato

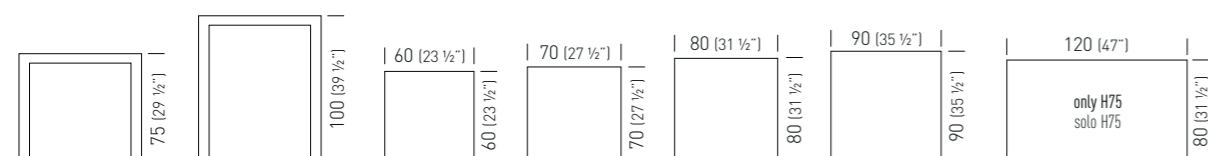
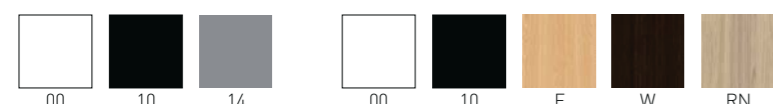

60x60	TSIML438._._/H75		0.28m³ / 16kg / 1pcs	€	908,00
60x60	TSIML438._._/H100		0.28m³ / 17kg / 1pcs	€	908,00
70x70	TSIML440._._/H75		0.28m³ / 17kg / 1pcs	€	382,00
70x70	TSIML440._._/H100		0.28m³ / 18kg / 1pcs	€	434,00
80x80	TSIML442._._/H75		0.40m³ / 18.5kg / 1pcs	€	400,00
80x80	TSIML442._._/H100		0.40m³ / 19.5kg / 1pcs	€	482,00
90x90	TSIML444._._/H75		0.40m³ / 21kg / 1pcs	€	434,00
90x90	TSIML444._._/H100		0.40m³ / 22kg / 1pcs	€	484,00
120x80	TSIML446._._/H75		0.40m³ / 23.5kg / 1pcs	€	586,00

Special Finishes / Finiture Speciali

Laminated: Special Laminated Surfaces Wood Effect 25 (p. 383) available on demand (min. 20pcs each code).
Special Laminated Surfaces Wood Effect 25 (p.383) disponibile su richiesta (min. 20pcs per codice).
Special Laminated Surfaces Fenix 25 (p. 384) available on demand (min. 20pcs each code).
Special Laminated Surfaces Fenix 25 (p. 384) disponibile su richiesta (min. 20pcs per codice).

Innovative and durable, the Space table is characterized by a thin Compactop profile and a solid four-legged structure in anodized aluminum. Resistant to stains, abrasions and thermal variations, the table can also be used for intensive use.

Innovativo e durevole, il tavolo Space è caratterizzato da un piano in Compactop dal profilo sottile e da una solida struttura a quattro gambe in alluminio anodizzato. Resistente alle macchie, alle abrasioni e alle variazioni termiche, il tavolo può essere utilizzato anche per utilizzi intensivi.



Frame Color / Colore Struttura Compactop Color / Colore Piano Compactop

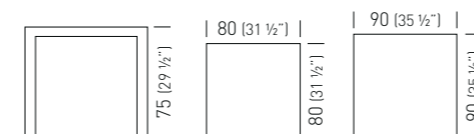

80x80	TSPAC410._._/H75		0.36m³ / 19kg / 1pcs	€	1.020,00
90x90	TSPAC412._._/H75		0.36m³ / 21kg / 1pcs	€	1.102,00

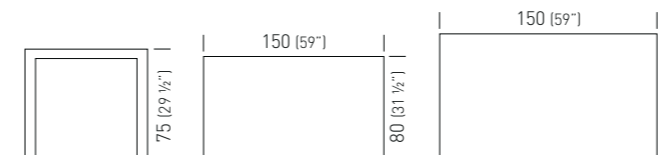

80x150	TSPAC414._._/H75		0.68m³ / 28kg / 1pcs	€	1.248,00
90x150	TSPAC416._._/H75		0.68m³ / 30kg / 1pcs	€	1.334,00

Compactop table-top and beech legs.
Or with technopolymer legs,
suitable for outdoor use. Lightweight and functional.
Tavolo con piano Compactop e gambe in legno di faggio.
Disponibile anche con gambe in tecnopolimero,
adatte all'uso esterno. Leggero e funzionale.



Compactop table-top and beech legs.
Or with technopolymer legs,
suitable for outdoor use. Lightweight and functional.
Tavolo con piano Compactop e gambe in legno di faggio.
Disponibile anche con gambe in tecnopolimero,
adatte all'uso esterno. Leggero e funzionale.

Wooden Frame Color / Colore Struttura Legno



Top Color / Colore Piano

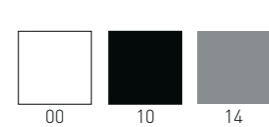

Special Finishes / Finiture Speciali

Compactop: Special Compactop Surfaces 10 (p. 378) available on demand (min. 20pcs each code).
Special Compactop Surfaces 10 (p. 378) disponibile su richiesta (min. 20pcs per codice).

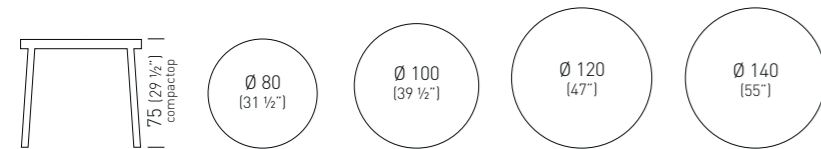

diam.80	TSTEC102._._/H75	0.4m³ / 18kg / 1pcs	€ 636,00
diam.80 fullcolor straight edge / bordo dritto (min 5pcs)	TSTEC103._._/H75	0.4m³ / 18kg / 1pcs	€ 764,00
diam.80 fullcolor inclined edge / bordo inclinato (min 5pcs)	TSTEC104._._/H75	0.4m³ / 18kg / 1pcs	€ 764,00
diam.100	TSTEC114._._/H75	0.58m³ / 19kg / 1pcs	€ 752,00
diam.100 fullcolor straight edge / bordo dritto (min 5pcs)	TSTEC115._._/H75	0.58m³ / 19kg / 1pcs	€ 926,00
diam.100 fullcolor inclined edge / bordo inclinato (min 5pcs)	TSTEC116._._/H75	0.58m³ / 19kg / 1pcs	€ 926,00
diam.120	TSTEC122._._/H75	0.71m³ / 20kg / 1pcs	€ 910,00
diam.120 fullcolor straight edge / bordo dritto (min 5pcs)	TSTEC123._._/H75	0.71m³ / 20kg / 1pcs	€ 1.092,00
diam.120 fullcolor inclined edge / bordo inclinato (min 5pcs)	TSTEC124._._/H75	0.71m³ / 20kg / 1pcs	€ 1.092,00
diam.140	TSTEC129._._/H75	0.87m³ / 24kg / 1pcs	€ 1.012,00
diam.140 fullcolor straight edge / bordo dritto (min 5pcs)	TSTEC130._._/H75	0.87m³ / 24kg / 1pcs	€ 1.214,00
diam.140 fullcolor inclined edge / bordo inclinato (min 5pcs)	TSTEC131._._/H75	0.87m³ / 24kg / 1pcs	€ 1.214,00

Wooden Frame Color / Colore Struttura Legno



Top Color / Colore Piano

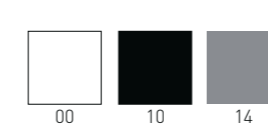

Special Finishes / Finiture Speciali

Compactop: Special Compactop Surfaces 10 (p. 378) available on demand (min. 20pcs each code).
Special Compactop Surfaces 10 (p. 378) disponibile su richiesta (min. 20pcs per codice).

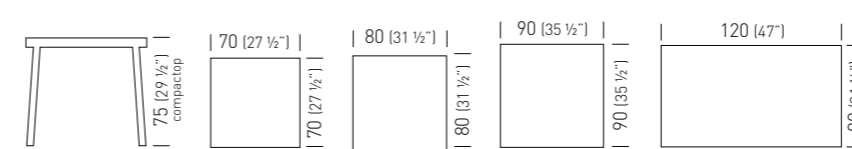

70x70	TSTEC098._._/H75	0.40m³ / 17kg / 1pcs	€ 514,00
70x70 fullcolor straight edge / bordo dritto (min 5pcs)	TSTEC099._._/H75	0.40m³ / 17kg / 1pcs	€ 620,00
70x70 fullcolor inclined edge / bordo inclinato (min 5pcs)	TSTEC100._._/H75	0.40m³ / 17kg / 1pcs	€ 620,00
80x80	TSTEC106._._/H75	0.40m³ / 18kg / 1pcs	€ 552,00
80x80 fullcolor straight edge / bordo dritto (min 5pcs)	TSTEC107._._/H75	0.40m³ / 18kg / 1pcs	€ 662,00
80x80 fullcolor inclined edge / bordo inclinato (min 5pcs)	TSTEC108._._/H75	0.40m³ / 18kg / 1pcs	€ 662,00
90x90	TSTEC110._._/H75	0.40m³ / 18.5kg / 1pcs	€ 654,00
90x90 fullcolor straight edge / bordo dritto (min 5pcs)	TSTEC111._._/H75	0.40m³ / 18.5kg / 1pcs	€ 784,00
90x90 fullcolor inclined edge / bordo inclinato (min 5pcs)	TSTEC112._._/H75	0.40m³ / 18.5kg / 1pcs	€ 784,00
120x80	TSTEC126._._/H75	0.52m³ / 20kg / 1pcs	€ 764,00
120x80 fullcolor straight edge / bordo dritto (min 5pcs)	TSTEC127._._/H75	0.52m³ / 20kg / 1pcs	€ 916,00
120x80 fullcolor inclined edge / bordo inclinato (min 5pcs)	TSTEC128._._/H75	0.52m³ / 20kg / 1pcs	€ 916,00

Technopolymer Frame Color / Colore Struttura Tecnopolimero

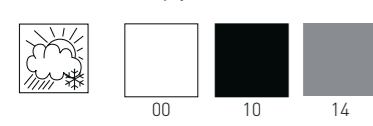

Top Color / Colore Piano

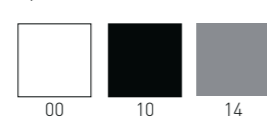

Special Finishes / Finiture Speciali

Compactop: Special Compactop Surfaces 10 (p. 378) available on demand (min. 20pcs each code).
Special Compactop Surfaces 10 (p. 378) disponibile su richiesta (min. 20pcs per codice).

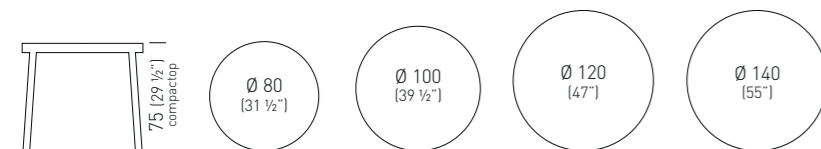

diam.80	TSTEC102._._/H75	0.4m³ / 18kg / 1pcs	€ 636,00
diam.80 fullcolor straight edge / bordo dritto (min 5pcs)	TSTEC103._._/H75	0.4m³ / 18kg / 1pcs	€ 764,00
diam.80 fullcolor inclined edge / bordo inclinato (min 5pcs)	TSTEC104._._/H75	0.4m³ / 18kg / 1pcs	€ 764,00
diam.100	TSTEC114._._/H75	0.58m³ / 19kg / 1pcs	€ 752,00
diam.100 fullcolor straight edge / bordo dritto (min 5pcs)	TSTEC115._._/H75	0.58m³ / 19kg / 1pcs	€ 926,00
diam.100 fullcolor inclined edge / bordo inclinato (min 5pcs)	TSTEC116._._/H75	0.58m³ / 19kg / 1pcs	€ 926,00
diam.120	TSTEC122._._/H75	0.71m³ / 20kg / 1pcs	€ 910,00
diam.120 fullcolor straight edge / bordo dritto (min 5pcs)	TSTEC123._._/H75	0.71m³ / 20kg / 1pcs	€ 1.092,00
diam.120 fullcolor inclined edge / bordo inclinato (min 5pcs)	TSTEC124._._/H75	0.71m³ / 20kg / 1pcs	€ 1.092,00
diam.140	TSTEC129._._/H75	0.87m³ / 24kg / 1pcs	€ 1.012,00
diam.140 fullcolor straight edge / bordo dritto (min 5pcs)	TSTEC130._._/H75	0.87m³ / 24kg / 1pcs	€ 1.214,00
diam.140 fullcolor inclined edge / bordo inclinato (min 5pcs)	TSTEC131._._/H75	0.87m³ / 24kg / 1pcs	€ 1.214,00

Technopolymer Frame Color / Colore Struttura Tecnopolimero

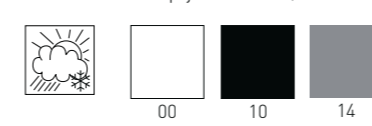

Top Color / Colore Piano

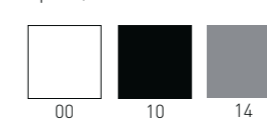

Special Finishes / Finiture Speciali

Compactop: Special Compactop Surfaces 10 (p. 378) available on demand (min. 20pcs each code).
Special Compactop Surfaces 10 (p. 378) disponibile su richiesta (min. 20pcs per codice).

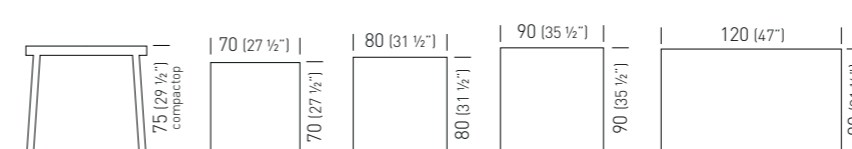

70x70	TSTEC098._._/H75	0.40m³ / 17kg / 1pcs	€ 514,00
70x70 fullcolor straight edge / bordo dritto (min 5pcs)	TSTEC099._._/H75	0.40m³ / 17kg / 1pcs	€ 620,00
70x70 fullcolor inclined edge / bordo inclinato (min 5pcs)	TSTEC100._._/H75	0.40m³ / 17kg / 1pcs	€ 620,00
80x80	TSTEC106._._/H75	0.40m³ / 18kg / 1pcs	€ 552,00
80x80 fullcolor straight edge / bordo dritto (min 5pcs)	TSTEC107._._/H75	0.40m³ / 18kg / 1pcs	€ 662,00
80x80 fullcolor inclined edge / bordo inclinato (min 5pcs)	TSTEC108._._/H75	0.40m³ / 18kg / 1pcs	€ 662,00
90x90	TSTEC110._._/H75	0.40m³ / 18.5kg / 1pcs	€ 654,00
90x90 fullcolor straight edge / bordo dritto (min 5pcs)	TSTEC111._._/H75	0.40m³ / 18.5kg / 1pcs	€ 784,00
90x90 fullcolor inclined edge / bordo inclinato (min 5pcs)	TSTEC112._._/H75	0.40m³ / 18.5kg / 1pcs	€ 784,00
120x80	TSTEC126._._/H75	0.52m³ / 20kg / 1pcs	€ 764,00
120x80 fullcolor straight edge / bordo dritto (min 5pcs)	TSTEC127._._/H75	0.52m³ / 20kg / 1pcs	€ 916,00
120x80 fullcolor inclined edge / bordo inclinato (min 5pcs)	TSTEC128._._/H75	0.52m³ / 20kg / 1pcs	€ 916,00

Stefano 3-Pod

Studio Eurolinea Design

Waiting areas and Coffee Table,
Compactop with three beech legs.
Tavolino attesa con piano Compactop
e tre gambe in legno di faggio.



Wooden Frame Color / Colore Struttura Legno



Top Color / Colore Piano

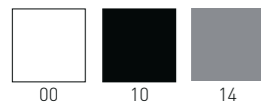

Special Finishes / Finiture Speciali

Compactop: Special Compactop Surfaces Fullcolor (p. 377) white available on demand (min. 5pcs each code).
Special Compactop Surfaces Fullcolor (p. 377) bianco disponibile su richiesta (min. 5pcs per codice).

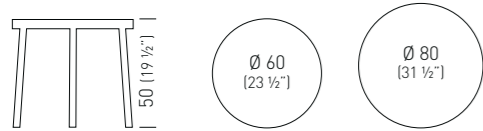

diam.60	TSTEC090._____/3H50	0.30m³ / 17kg / 1pcs	€ 508,00
diam.80	TSTEC102._____/3H50	0.40m³ / 18kg / 1pcs	€ 586,00

Stefanino

Studio Eurolinea Design

Waiting areas and Coffee Table,
Compactop with beech legs.
Tavolino attesa con piano Compactop
e gambe in legno di faggio.



Wooden Frame Color / Colore Struttura Legno



Top Color / Colore Piano

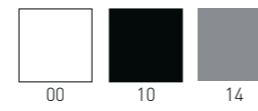

Fullcolor

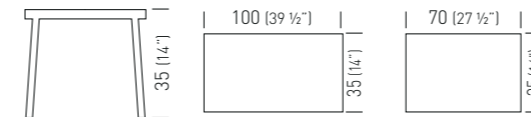

100x35	TSTEC118._____/H35	0.34m³ / 10kg / 1pcs	€ 408,00
70x35	TSTEC094._____/H35	0.34m³ / 7kg / 1pcs	€ 382,00

Step

Studio Eurolinea Design

High table, co-injected metal frame with techno polymer, Compactop. Suitable for outdoor purpose.

Tavolo alto con struttura in metallo sovrastampato con tecnopolimero, piano in Compactop. Adatto anche all'uso esterno.



Technopolymer Frame Color / Colore Struttura Tecnopolimero

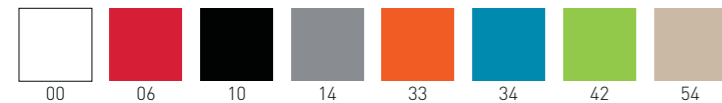

Compactop Color / Colore Piano Compactop

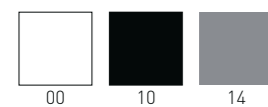

Special Finishes / Finiture Speciali

Compactop: Special Compactop Surfaces 10 (p. 378) available on demand (min. 20pcs each code).
Special Compactop Surfaces 10 (p. 378) disponibile su richiesta (min. 20pcs per codice).

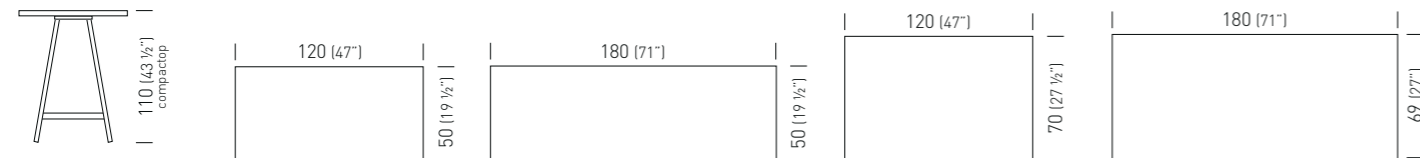

120x50	TSTPC820__-_/H110		0.47m ³ / 35kg / 1pcs	€	878,00
120x50fullcolor (min 5pcs)	TSTPC821.00-_/H110		0.47m ³ / 35kg / 1pcs	€	966,00
120x70	TSTPC822__-_/H110		0.48m ³ / 36kg / 1pcs	€	922,00
120x70fullcolor (min 5pcs)	TSTPC823.00-_/H110		0.48m ³ / 36kg / 1pcs	€	1.104,00
180x50	TSTPC824__-_/H110		0.60m ³ / 42kg / 1pcs	€	908,00
180x50fullcolor (min 5pcs)	TSTPC825.00-_/H110		0.60m ³ / 42kg / 1pcs	€	1.090,00
180x69	TSTPC826__-_/H110		0.60m ³ / 43kg / 1pcs	€	950,00
180x69fullcolor (min 5pcs)	TSTPC827.00-_/H110		0.60m ³ / 43kg / 1pcs	€	1.140,00



Surfy 2027 Tables & Desks

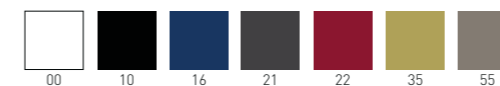

Table collection, meeting tables and modular desks, part of the "2027" system, suitable for completing hospitality and office settings with integrated design. The tables are made with painted metal structures and Laminate or Compactop table-tops, available with metal fairlead solutions.

Collezione tavoli, tavoli meeting e scrivanie modulari, parte del sistema "2027", adatti a completare con lo stesso design progetti integrati di ospitalità ed ufficio. I tavoli sono realizzati con strutture in metallo verniciato e piani in Laminato o Compactop, disponibili con soluzioni passacavi in metallo. Strutture di sostegno con forma a cavalletto per essere snelle e resistenti, oltre che colorate a tutto tondo.

Finishings / Finiture

Frame colors / Colori struttura



Laminated top color / Colori piano laminato

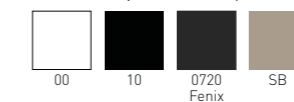

SURFY HUB 2027 ROUND



Frame colors / Colori struttura



Laminated Top Color / Colore Piano Laminato

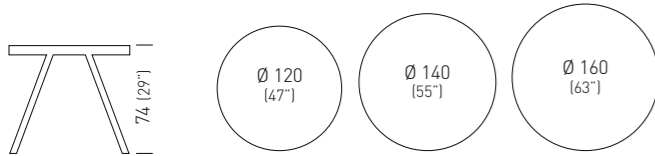

diam. 120laminated	TSRHL260._-_/H74	0.71m³ / 30kg / 1pcs	€	1.002,00
diam. 120lam.fenix	TSRHL260.0720-_/H74	0.71m³ / 30kg / 1pcs	€	1.312,00
diam. 140laminated	TSRHL262._-_/H74	0.90m³ / 37kg / 1pcs	€	1.312,00
diam. 140lam.fenix	TSRHL262.0720-_/H74	0.90m³ / 37kg / 1pcs	€	1.816,00
diam. 160laminated	TSRHL264._-_/H74	1.1m³ / 43kg / 1pcs	€	2.250,00
diam. 160lam.fenix	TSRHL264.0720-_/H74	1.1m³ / 43kg / 1pcs	€	3.148,00

SURFY OUTDOOR 2027 ROUND



Frame colors / Colori struttura



Laminated Top Color / Colore Piano Laminato

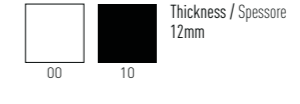

diam. 120Compactop	TSROC280._-_/H73	0.71m³ / 35kg / 1pcs	€	1.234,00
diam. 140Compactop	TSROC286._-_/H73	0.90m³ / 41kg / 1pcs	€	1.756,00
diam. 160Compactop	TSROC292._-_/H73	1.1m³ / 49kg / 1pcs	€	2.832,00

SURFY HUB 2027 SQUARE



Frame colors / Colori struttura



Laminated Top Color / Colore Piano Laminato

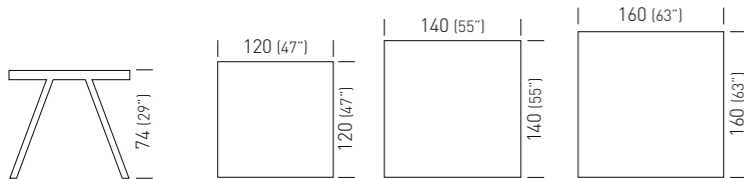
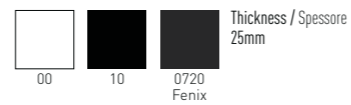

120x120laminated	TSRHL261._-_/H74	0.71m³ / 34kg / 1pcs	€	1.002,00
120x120lam.fenix	TSRHL261.0720-_/H74	0.71m³ / 34kg / 1pcs	€	1.312,00
140x140laminated	TSRHL263._-_/H74	0.90m³ / 41kg / 1pcs	€	1.312,00
140x140lam.fenix	TSRHL263.0720-_/H74	0.90m³ / 41kg / 1pcs	€	1.816,00
160x160laminated	TSRHL265._-_/H74	1.1m³ / 50kg / 1pcs	€	2.250,00
160x160lam.fenix	TSRHL265.0720-_/H74	1.1m³ / 50kg / 1pcs	€	3.148,00

SURFY OUTDOOR 2027 SQUARE



Frame colors / Colori struttura



Laminated Top Color / Colore Piano Laminato

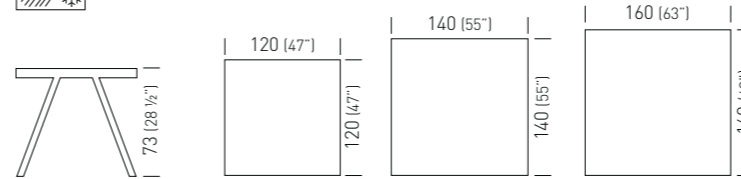

120x120Compactop	TSROC283._-_/H73	0.71m³ / 39kg / 1pcs	€	1.234,00
140x140Compactop	TSROC289._-_/H73	0.90m³ / 49kg / 1pcs	€	1.756,00
160x160Compactop	TSROC295._-_/H73	1.1m³ / 59kg / 1pcs	€	2.832,00

SURFY HUB 2027 OVAL



Frame colors / Colori struttura

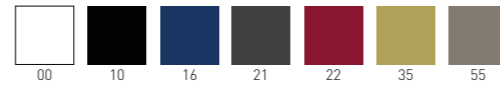

Laminated Top Color / Colore Piano Laminato

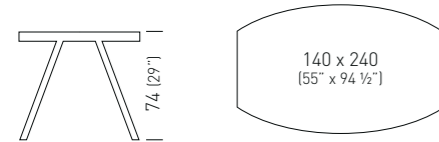
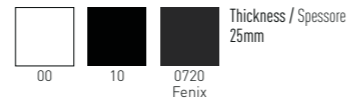

140x240laminated
140x240lam.fenix

TSRHL275._-_/H74
TSRHL275.0720-_/H74

1.50m³ / 74kg / 1pcs
1.50m³ / 74kg / 1pcs

€ 3.388,00
€ 3.872,00

Option: Cod. ACCV030...
Metal Fairlead Solution
Tubo metallico passacavi
€ 96,00

Colors / Colori

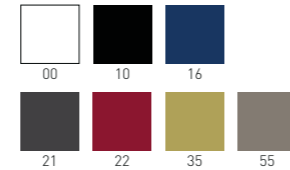

SURFY HUB 2027 RECTANGLE



Frame colors / Colori struttura



Laminated Top Color / Colore Piano Laminato

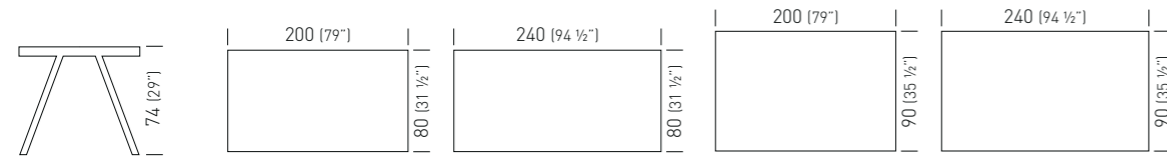
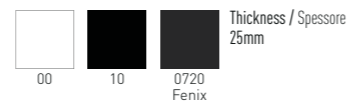

80x200laminated
80x200lam.fenix
80x240laminated
80x240lam.fenix
90x200laminated
90x200lam.fenix
90x240laminated
90x240lam.fenix

TSRHL266._-_/H74
TSRHL266.0720-_/H74
TSRHL267._-_/H74
TSRHL267.0720-_/H74
TSRHL268._-_/H74
TSRHL268.0720-_/H74
TSRHL269._-_/H74
TSRHL269.0720-_/H74

0.76m³ / 41kg / 1pcs
0.76m³ / 41kg / 1pcs
0.90m³ / 46kg / 1pcs
0.90m³ / 46kg / 1pcs
0.90m³ / 44kg / 1pcs
0.90m³ / 44kg / 1pcs
1.0m³ / 51kg / 1pcs
1.0m³ / 51kg / 1pcs

€ 1.404,00
€ 1.670,00
€ 1.574,00
€ 1.912,00
€ 1.548,00
€ 1.840,00
€ 1.766,00
€ 2.130,00

Option: Cod. ACCV030...
Metal Fairlead Solution
Tubo metallico passacavi
€ 96,00

Colors / Colori

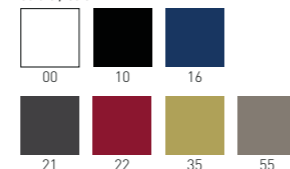

SURFY HUB 2027 RECTANGLE



Frame colors / Colori struttura

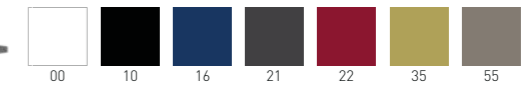

Laminated Top Color / Colore Piano Laminato

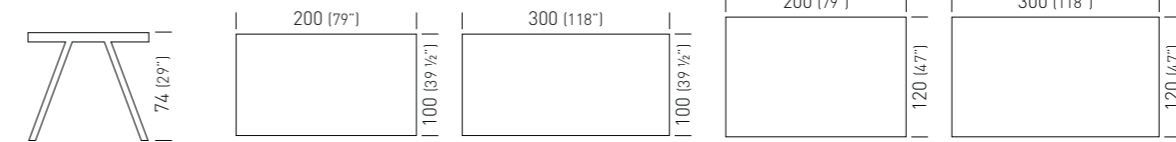
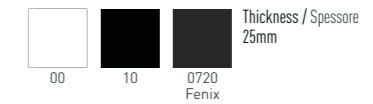

100x200laminated
100x200lam.fenix
100x300laminated
100x300lam.fenix
120x200laminated
120x200lam.fenix
120x300laminated
120x300lam.fenix

TSRHL270._-_/H74
TSRHL270.0720-_/H74
TSRHL271._-_/H74
TSRHL271.0720-_/H74
TSRHL272._-_/H74
TSRHL272.0720-_/H74
TSRHL273._-_/H74
TSRHL273.0720-_/H74

0.92m³ / 45kg / 1pcs
0.92m³ / 45kg / 1pcs
1.4m³ / 65kg / 1pcs
1.4m³ / 65kg / 1pcs
1.1m³ / 52kg / 1pcs
1.1m³ / 52kg / 1pcs
1.6m³ / 74kg / 1pcs
1.6m³ / 74kg / 1pcs

€ 1.524,00
€ 1.816,00
€ 2.662,00
€ 3.146,00
€ 1.670,00
€ 1.984,00
€ 3.050,00
€ 3.534,00

Option: Cod. ACCV030...
Metal Fairlead Solution
Tubo metallico passacavi
€ 96,00

Colors / Colori

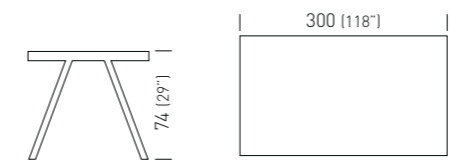
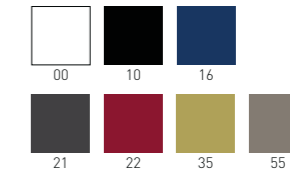

140x300laminated
140x300lam.fenix

TSRHL276._-_/H74
TSRHL276.0720-_/H74

1.9m³ / 81kg / 1pcs
1.9m³ / 81kg / 1pcs

€ 3.534,00
€ 4.114,00

Option: Cod. ACCV030...
Metal Fairlead Solution
Tubo metallico passacavi
€ 96,00

Colors / Colori

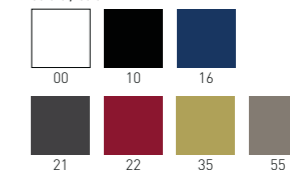

SURFY DESK 2027

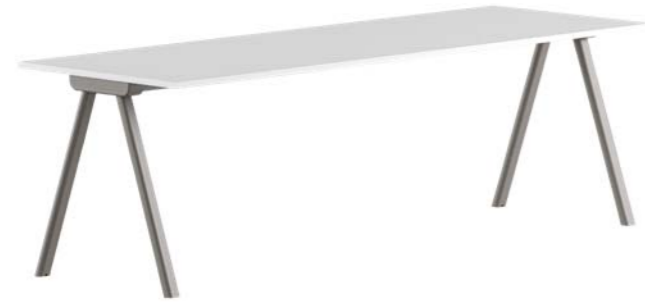

Frame colors / Colori struttura



Option: Cod. 1101
Cable Routing Option,
anodized Aluminum 8x8 cm,
black brush
Opzione Passacavi,
Alluminio anodizzato 8x8 cm
spazzolina nera
€ 160,00

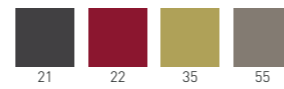
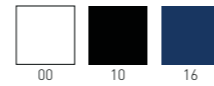

Option: Cod. ACCV030
Metal Fairlead Solution
Tubo metallico passacavi
€ 96,00

Colors / Colori

Laminated Top Color / Colore Piano Laminato

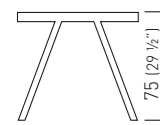
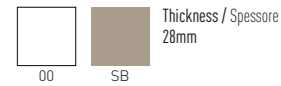

140 (55")	160 (63")	180 (71")	240 (94 1/2")
80 (31 1/2")	80 (31 1/2")	80 (31 1/2")	80 (31 1/2")
140 (55")	160 (63")	180 (71")	240 (94 1/2")
90 (35 1/2")	90 (35 1/2")	90 (35 1/2")	90 (35 1/2")

80x140laminated	TSRDL300._._/H74	0.41m³ / 32kg / 1pcs	€ 1.162,00
80x160laminated	TSRDL320._._/H74	0.51m³ / 35kg / 1pcs	€ 1.332,00
80x180laminated	TSRDL301._._/H74	0.60m³ / 38kg / 1pcs	€ 1.356,00
80x240laminated	TSRDL302._._/H74	0.90m³ / 46.5kg / 1pcs	€ 1.646,00
90x140laminated	TSRDL303._._/H74	0.65m³ / 34kg / 1pcs	€ 1.282,00
90x160laminated	TSRDL321._._/H74	0.73m³ / 37kg / 1pcs	€ 1.380,00
90x180laminated	TSRDL304._._/H74	0.80m³ / 40kg / 1pcs	€ 1.404,00
90x240laminated	TSRDL305._._/H74	1.0m³ / 50kg / 1pcs	€ 1.840,00

Laminated Top Color / Colore Piano Laminato

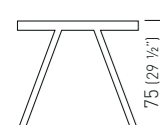
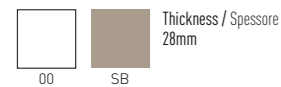

140 (55")	180 (71")	240 (94 1/2")
100 (39 1/2")	100 (39 1/2")	100 (39 1/2")
140 (55")	180 (71")	240 (94 1/2")
120 (47")	120 (47")	120 (47")



Option: Cod. 1101
Cable Routing Option,
anodized Aluminum 8x8 cm,
black brush
Opzione Passacavi,
Alluminio anodizzato 8x8 cm
spazzolina nera
€ 160,00



Option: Cod. ACCV030
Metal Fairlead Solution
Tubo metallico passacavi
€ 96,00

Colors / Colori

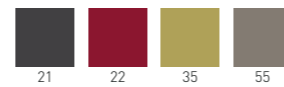
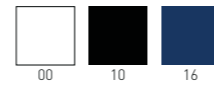

Surfy Desk 2027			
100x140laminated	TSRDL306._._/H74	0.70m³ / 40.5kg / 1pcs	€ 1.404,00
100x180laminated	TSRDL307._._/H74	0.85m³ / 49kg / 1pcs	€ 1.524,00
100x240laminated	TSRDL308._._/H74	1.1m³ / 62kg / 1pcs	€ 2.032,00
120x140laminated	TSRDL309._._/H74	0.8m³ / 46kg / 1pcs	€ 1.598,00
120x180laminated	TSRDL310._._/H74	1.0m³ / 56kg / 1pcs	€ 1.766,00
120x240laminated	TSRDL311._._/H74	1.3m³ / 72kg / 1pcs	€ 2.324,00

SURFY DESK BRIDGE 2027



Frame colors / Colori struttura

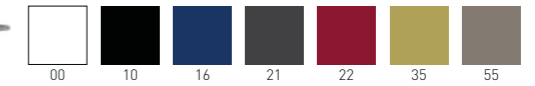

Laminated Top Color / Colore Piano Laminato

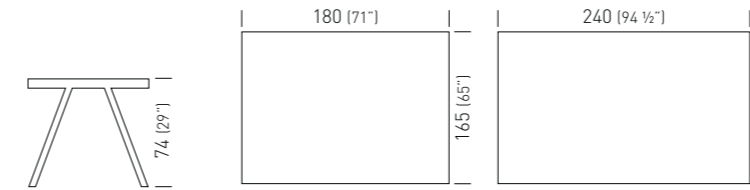
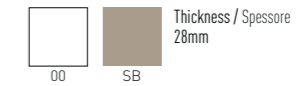

165x180laminated	TSRDL314._._/H74	0.90m³ / 87kg / 1pcs	€ 3.050,00
165x240laminated	TSRDL316._._/H74	1.20m³ / 109kg / 1pcs	€ 3.484,00

Table Extension / Modulo Aggiuntivo			
165x180laminated	TSRDL315._._/H74	0.40m³ / 77kg / 1pcs	€ 2.744,00
165x240laminated	TSRDL317._._/H74	0.50m³ / 99kg / 1pcs	€ 3.138,00



Option: Cod. 1101
Cable Routing Option,
anodized Aluminum 8x8 cm,
black brush
Opzione Passacavi,
Alluminio anodizzato 8x8 cm
spazzolina nera
€ 160,00



Option: Cod. ACCV030
Metal Fairlead Solution
Tubo metallico passacavi
€ 96,00

Colors / Colori

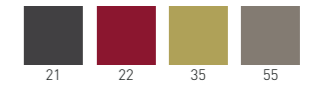
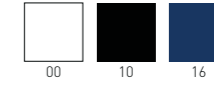

SURFY HIGH DESK 2027



Frame colors / Colori struttura

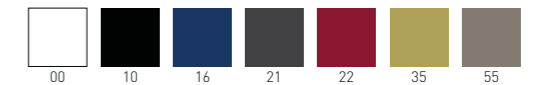

Laminated Top Color / Colore Piano Laminato

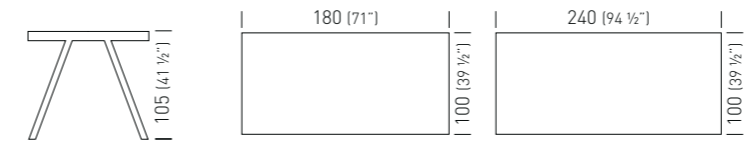
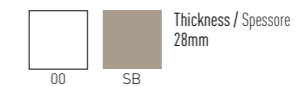

100x180laminated	TSRDL307._._/H105	0.85m³ / 57kg / 1pcs	€ 2.008,00
100x240laminated	TSRDL308._._/H105	1.10m³ / 69kg / 1pcs	€ 2.372,00



Option: Cod. 1101
Cable Routing Option,
anodized Aluminum 8x8 cm,
black brush
Opzione Passacavi,
Alluminio anodizzato 8x8 cm
spazzolina nera
€ 160,00



Option: Cod. ACCV030
Metal Fairlead Solution
Tubo metallico passacavi
€ 96,00

Colors / Colori

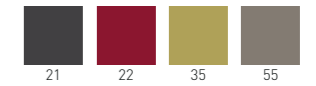
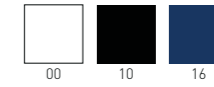

SURFY DESK 2027 L VERSION

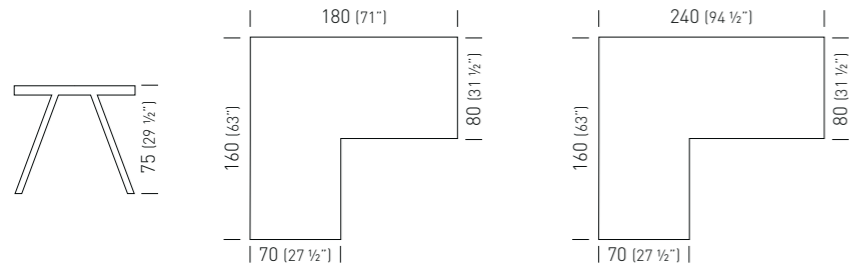
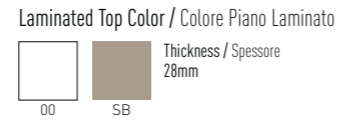
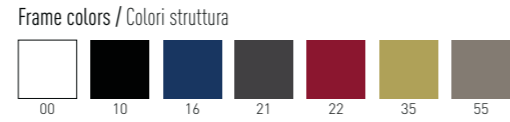

80x180laminated	TSRDL330.___/H75	0.65m³ / 53kg / 1pc	€ 1.912,00
80x240laminated	TSRDL331.___/H75	0.95m³ / 61.5kg / 1pc	€ 2.190,00

Option: Cod. 1101
Cable Routing Option,
anodized Aluminum 8x8 cm,
black brush

Option: Cod. ACCV030.
Metal Fairlead Solution
Tubo metallico passacavi
€ **96,00**

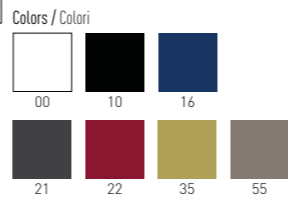

Surfy Outdoor 2027 Coffee Table

Studio Eurolinea Design

Waiting areas and Coffee Table, Compactop with
three metal legs frame.
Tavolino attesa con piano in Compactop e
struttura a tre gambe in metallo.

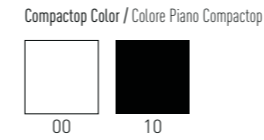
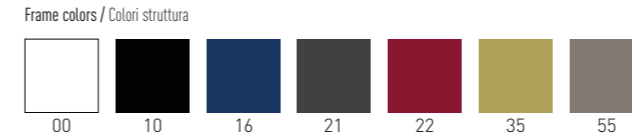

diam.68 compactop	TSROC278.___/H35	0.15m³ / 11kg / 1pc	€ 522,00
diam.68 fullcolor (min 5pcs)	TSROC279.___/H35	0.15m³ / 11kg / 1pc	€ 572,00
diam.68 compactop	TSROC278.___/H50	0.15m³ / 11.50kg / 1pc	€ 532,00
diam.68 fullcolor (min 5pcs)	TSROC279.___/H50	0.15m³ / 11.50kg / 1pc	€ 584,00
diam.80 compactop	TSROC297.___/H50	0.18m³ / 14kg / 1pc	€ 570,00
diam.80 fullcolor (min 5pcs)	TSROC298.___/H50	0.18m³ / 14kg / 1pc	€ 644,00

Surfy Hub 2027 Coffee Table

Studio Eurolinea Design

Waiting areas and Coffee Table, Laminated Table Top with four metal legs frame.
Tavolino attesa con piano in Laminato e struttura a 4 gambe in metallo.

Frame colors / Colori struttura



Laminated Top Color / Colore Piano Laminato

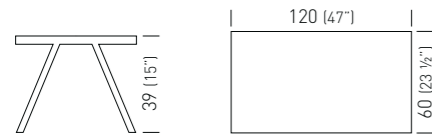
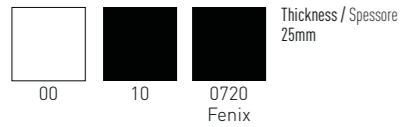

60x120 laminated	TSRHL256. __-_/H39	0.65m ³ / 22Kg / 1pc	€	702,00
60x120 lam.fenix	TSRHL256.0720-_/H39	0.65m ³ / 22Kg / 1pc	€	830,00



Tag Marble

Ilaria Marelli Design

The Marble tops, characterized by always different veins of natural stones, contribute to enhance elegance and refinement for the most demanding environments. The solid Marble surfaces, shiny and glossy, are treated to reduce their porosity, however constant care and cleaning of the product is recommended.

I piani in Marmo, caratterizzati dalle sempre diverse venature della pietra naturale, offrono eleganza e raffinatezza, per completare con esclusività gli ambienti più ricercati. I solidi piani in Marmo, splendenti e lucidi, sono trattati per ridurre la porosità, tuttavia si consiglia pulizia costante e cura nell'utilizzo del prodotto.

Frame Color / Colore Struttura

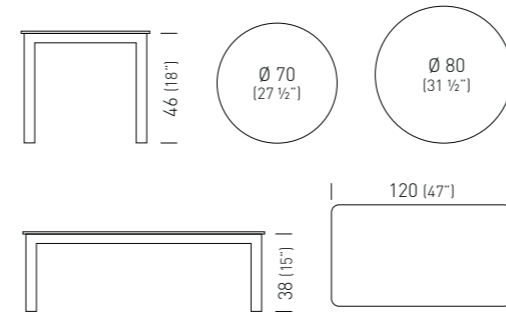
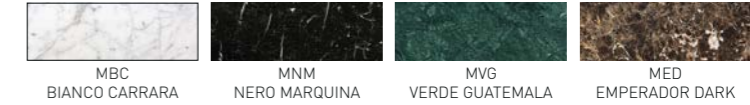
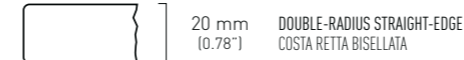
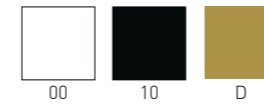

diam. 70	TTAGM403. __-_/H45	0.55m ³ / 25kg / 1pc	€	944,00
diam. 80	TTAGM404. __-_/H45	0.55m ³ / 31kg / 1pc	€	1.108,00
60x120	TTAGM405. __-_/H37	0.50m ³ / 42kg / 1pc	€	1.574,00

Tag Porcelain

Ilaria Marelli Design

The Porcelain stoneware tops stand out for their excellent technical performance, ideal for the most delicate uses where maximum hygiene and resistance must be guaranteed. Porcelain tops are compatible with foodstuffs, resistant to fungi and molds, suitable for both indoor and outdoor use, resistant to frost, heat and high temperatures, they can be cleaned very easily while maintaining the characteristics of the surface.

I piani in Gres Porcellanato si distinguono per le eccellenti performance tecniche, ideali negli impieghi più delicati nei quali è necessario garantire la massima igiene e resistenza. I piani Porcelain sono compatibili con le sostanze alimentari, resistenti a funghi e muffe, idonei ad un utilizzo sia interno che esterno, resistenti al gelo, al calore alle alte temperature, si possono pulire con estrema facilità mantenendo inalterate le caratteristiche della superficie.



Frame Color / Colore Struttura

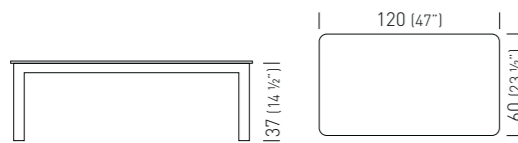
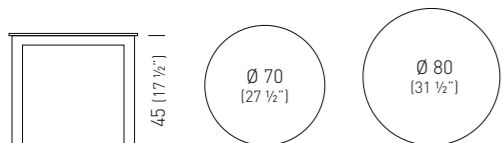
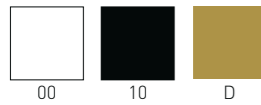

diam. 70	TTAGP407._._/H45	0.55m³ / 27kg / 1pc	€ 1.092,00
diam. 80	TTAGP408._._/H45	0.55m³ / 31.5kg / 1pc	€ 1.266,00
60x120	TTAGP409._._/H37	0.50m³ / 40kg / 1pc	€ 1.320,00

Min. order 10pcs
each code
Ordine min 10pz
per codice

Together

Mark Sadler Design

Natural Oak wood table top and polycarbonate legs: transparent, solid white, solid black.
Tavolo con piano in legno di rovere, gambe in polycarbonato trasparente, bianche o nere.



Technopolymer Frame Color / Colore Struttura Tecnopolimero

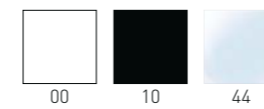

Top Color / Colore Piano

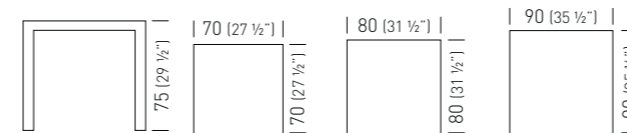

70x70	TTOGL420._._/H75	0.40m³ / 16kg / 1pcs	€ 1.210,00
80x80	TTOGL422._._/H75	0.40m³ / 18kg / 1pcs	€ 1.258,00
90x90	TTOGL424._._/H75	0.40m³ / 20kg / 1pcs	€ 1.332,00

Together

Mark Sadler Design

Together is a solid and versatile table, suitable to be utilized with elegance in all modern environments. The legs, made of natural solid oak, are combined with a natural oak veneered top, thus obtaining a pleasant visual play of solid interlocking between the leg and the top. With a simple and elegant design, Together adapts to any decorative context, expressing the warmth of wood and its small details. The legs are always at the extreme of tops sizes. Together è un tavolo solido e versatile, adatto ad essere inserito con eleganza in tutti gli ambienti moderni. Le gambe, realizzate in rovere massello naturale, sono abbinata ad un piano impiallacciato rovere naturale, ottenendo così un piacevole gioco visivo di solido incastro tra la gamba e il piano. Dal design semplice ed elegante, Together si adatta a qualunque contesto decorativo esprimendo il calore del legno ed i suoi piccoli dettagli. Le gambe restano sempre all' estremo.

Wooden Frame Color / Colore Struttura Legno Top Color / Colore Piano

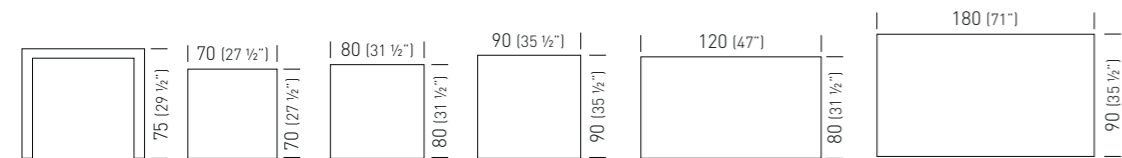

70x70	TTOGL420._._/H75	0.40m³ / 16kg / 1pcs	€ 1.210,00
80x80	TTOGL422._._/H75	0.40m³ / 18kg / 1pcs	€ 1.258,00
90x90	TTOGL424._._/H75	0.40m³ / 20kg / 1pcs	€ 1.332,00
120x80	TTOGL426._._/H75	0.48m³ / 24kg / 1pcs	€ 2.058,00
180x90	TTOGL428._._/H75	0.80m³ / 33kg / 1pcs	€ 2.904,00

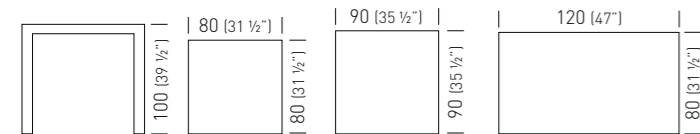

80x80	TTOGL422._._/H100	0.42m³ / 22kg / 1pcs	€ 1.452,00
90x90	TTOGL424._._/H100	0.42m³ / 24kg / 1pcs	€ 1.500,00
120x80	TTOGL426._._/H100	0.50m³ / 27kg / 1pcs	€ 2.274,00

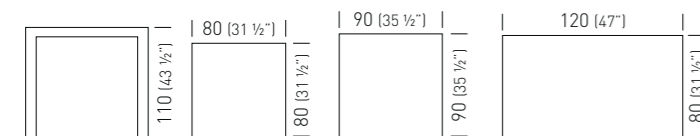

80x80	TTOGL422._._/H110	0.42m³ / 22kg / 1pcs	€ 1.524,00
90x90	TTOGL424._._/H110	0.42m³ / 24kg / 1pcs	€ 1.574,00
120x80	TTOGL426._._/H110	0.50m³ / 27kg / 1pcs	€ 2.300,00



Wooden Frame Color / Colore Struttura Legno



Top Color / Colore Piano

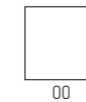

Fullcolor

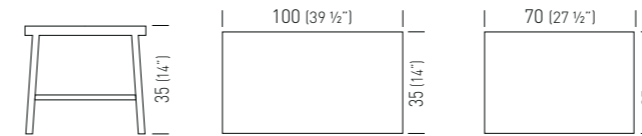

100x35	TWOOC132.00-F/H35	0.18m³ / 12kg / 1pcs	€ 498,00
70x35	TWOOC130.00-F/H35	0.13m³ / 9kg / 1pcs	€ 468,00

Woody

Favaretto & Partners Design

Waiting areas and Coffee Table, double Compactop deck and beech legs. Tavolino attesa con doppio piano Compactop e gambe in legno di faggioio.

TKITT
Collection

TABLES FOR INDOOR AND OUT



TKITT.BG3K

H75 Table with technopolymer top, BG3K 3-spur metal-technopolymer co-injected table base, Ø 80mm anodized aluminum column.

Tavolo con piano in tecnopolimero H75, basamento BG3K a tre razze in metallo sovrastampato con tecnopolimero, colonna in alluminio anodizzato Ø 80mm.



■ TKITT04._/BG3K	0.13m³ / 13.8kg / 1pcs	€ 314,00
■ TKITT04._/BG3K.10	0.13m³ / 13.8kg / 1pcs	€ 344,00

■ TKITT03._/BG3K	0.15m³ / 14.5kg / 1pcs	€ 342,00
■ TKITT03._/BG3K.10	0.15m³ / 14.5kg / 1pcs	€ 376,00



■ TKITT20._/BG3K	0.13m³ / 14.6kg / 1pcs	€ 330,00
■ TKITT20._/BG3K.10	0.13m³ / 14.6kg / 1pcs	€ 366,00

■ TKITT06._/BG3K	0.15m³ / 15.8kg / 1pcs	€ 376,00
■ TKITT06._/BG3K.10	0.15m³ / 15.8kg / 1pcs	€ 410,00

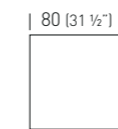

■ TKITT23._/BG3K	0.16m³ / 18.4kg / 1pcs	€ 392,00
■ TKITT23._/BG3K.10	0.16m³ / 18.4kg / 1pcs	€ 432,00

Top Color / Colore Piano



TKITT.BG3L

H75 Table with technopolymer top, BG3L 3-spur metal-technopolymer co-injected table base, Ø 80mm anodized aluminum column.

Tavolo con piano in tecnopolimero H75, basamento BG3L a tre razze in metallo sovrastampato con tecnopolimero, colonna in alluminio anodizzato Ø 80mm.

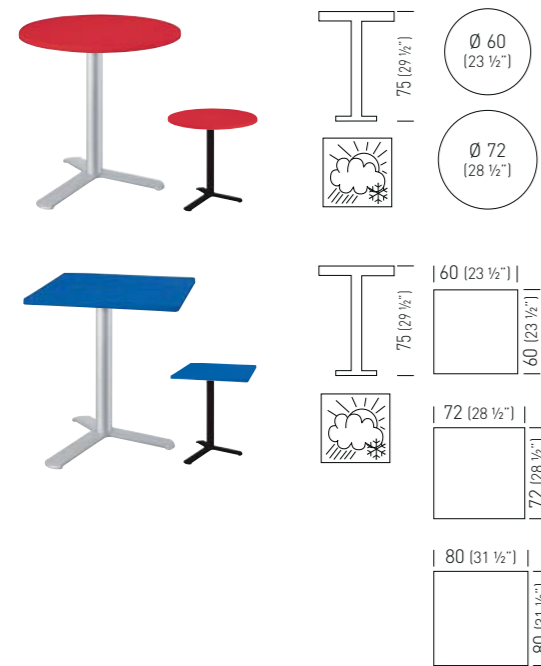

■ TKITT04._/BG3L		0.14m³ / 15kg / 1pcs	€ 314,00
■ TKITT04._/BG3L.10		0.14m³ / 15kg / 1pcs	€ 344,00
■ TKITT03._/BG3L		0.16m³ / 15.7kg / 1pcs	€ 342,00
■ TKITT03._/BG3L.10		0.16m³ / 15.7kg / 1pcs	€ 376,00
■ TKITT20._/BG3L		0.14m³ / 15.8kg / 1pcs	€ 330,00
■ TKITT20._/BG3L.10		0.14m³ / 15.8kg / 1pcs	€ 366,00
■ TKITT06._/BG3L		0.16m³ / 17kg / 1pcs	€ 376,00
■ TKITT06._/BG3L.10		0.16m³ / 17kg / 1pcs	€ 410,00
■ TKITT23._/BG3L		0.17m³ / 19.6kg / 1pcs	€ 392,00
■ TKITT23._/BG3L.10		0.17m³ / 19.6kg / 1pcs	€ 432,00

TKITT.BG4K

H75 Table with technopolymer top, BG4K 4-spur metal-technopolymer co-injected table base, Ø 80mm anodized aluminum column.

Tavolo con piano in tecnopolimero H75, basamento BG4K a quattro razze in metallo sovrastampato con tecnopolimero, colonna in alluminio anodizzato Ø 80mm.

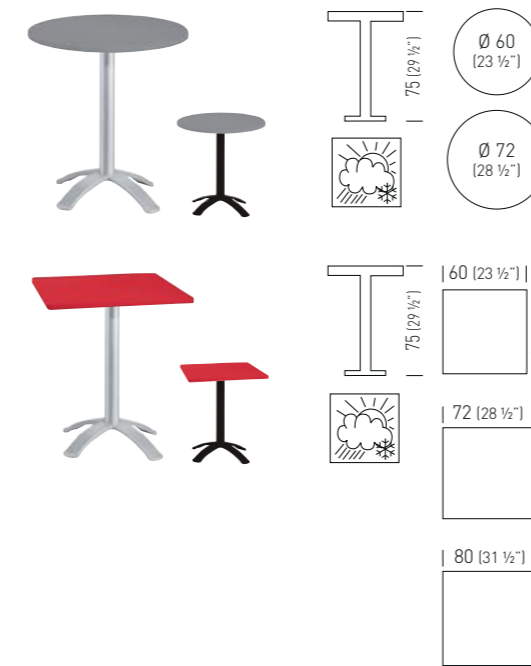

■ TKITT04._/BG4K		0.13m³ / 16.5kg / 1pcs	€ 330,00
■ TKITT04._/BG4K.10		0.13m³ / 16.5kg / 1pcs	€ 366,00
■ TKITT03._/BG4K		0.15m³ / 17.2kg / 1pcs	€ 356,00
■ TKITT03._/BG4K.10		0.15m³ / 17.2kg / 1pcs	€ 394,00
■ TKITT20._/BG4K		0.13m³ / 17.3kg / 1pcs	€ 346,00
■ TKITT20._/BG4K.10		0.13m³ / 17.3kg / 1pcs	€ 380,00
■ TKITT06._/BG4K		0.15m³ / 18.5kg / 1pcs	€ 392,00
■ TKITT06._/BG4K.10		0.15m³ / 18.5kg / 1pcs	€ 432,00
■ TKITT23._/BG4K		0.16m³ / 21.1kg / 1pcs	€ 410,00
■ TKITT23._/BG4K.10		0.16m³ / 21.1kg / 1pcs	€ 452,00

TKITT.BGA3L

H110 Table with technopolymer top, BG3L 3-spur metal-technopolymer co-injected table base, Ø 80mm anodized aluminum column.

Tavolo con piano in tecnopolimero H110, basamento BG3L a tre razze in metallo sovrastampato con tecnopolimero, colonna in alluminio anodizzato Ø 80mm.

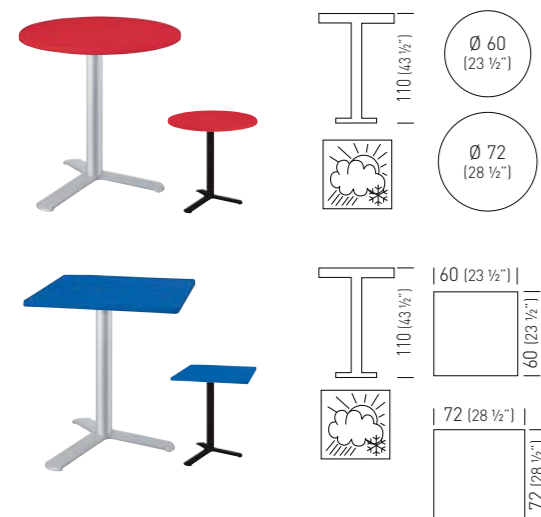

■ TKITT04._/BGA3L		0.18m³ / 15.8kg / 1pcs	€ 396,00
■ TKITT04._/BGA3L.10		0.18m³ / 15.8kg / 1pcs	€ 436,00
■ TKITT03._/BGA3L		0.20m³ / 16.5kg / 1pcs	€ 426,00
■ TKITT03._/BGA3L.10		0.20m³ / 16.5kg / 1pcs	€ 466,00
■ TKITT20._/BGA3L		0.18m³ / 16.6kg / 1pcs	€ 414,00
■ TKITT20._/BGA3L.10		0.18m³ / 16.6kg / 1pcs	€ 456,00
■ TKITT06._/BGA3L		0.20m³ / 17.8kg / 1pcs	€ 416,00
■ TKITT06._/BGA3L.10		0.20m³ / 17.8kg / 1pcs	€ 458,00

TKITT.BGA4K

H115 Table with technopolymer top, BG4K 4-spur metal-technopolymer co-injected table base, Ø 80mm anodized aluminum column.

Tavolo con piano in tecnopolimero H115, basamento BG4K a quattro razze in metallo sovrastampato con tecnopolimero, colonna in alluminio anodizzato Ø 80mm.

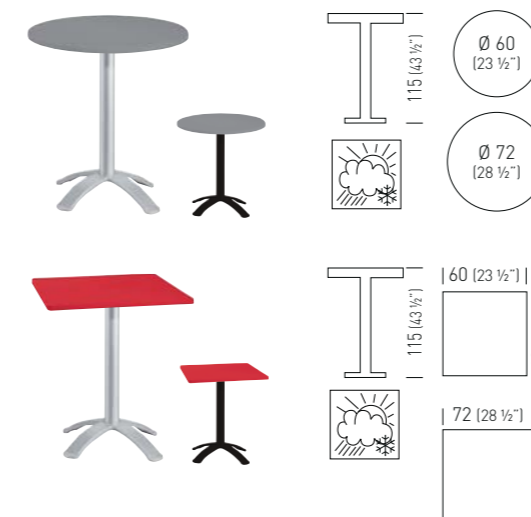

■ TKITT04._/BGA4K		0.17m³ / 17.3kg / 1pcs	€ 436,00
■ TKITT04._/BGA4K.10		0.17m³ / 17.3kg / 1pcs	€ 482,00
■ TKITT03._/BGA4K		0.19m³ / 18kg / 1pcs	€ 462,00
■ TKITT03._/BGA4K.10		0.19m³ / 18kg / 1pcs	€ 510,00
■ TKITT20._/BGA4K		0.17m³ / 18.1kg / 1pcs	€ 454,00
■ TKITT20._/BGA4K.10		0.17m³ / 18.1kg / 1pcs	€ 500,00
■ TKITT06._/BGA4K		0.19m³ / 19.3kg / 1pcs	€ 500,00
■ TKITT06._/BGA4K.10		0.19m³ / 19.3kg / 1pcs	€ 550,00

Top Color / Colore Piano



Top Color / Colore Piano



TKITT.BG4J

H73 Table with technopolymer top, BG4J 4-spur metal-technopolymer co-injected table base, 80x80mm anodized aluminum column.

Tavolo con piano in tecnopolimero H73, basamento BG4J a quattro razze in metallo sovrastampato con tecnopolimero, colonna in alluminio anodizzato 80x80mm.

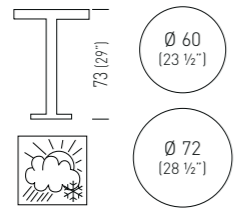
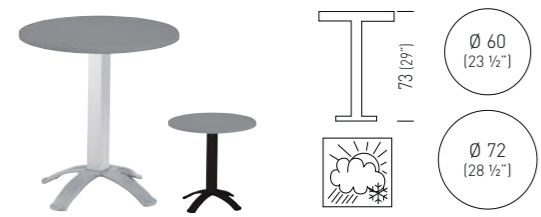

■ TKITT04._/BG4J		0.16m³ / 16.8kg / 1pcs	€ 346,00
■ TKITT04._/BG4J.10		0.16m³ / 16.8kg / 1pcs	€ 380,00
■ TKITT03._/BG4J		0.18m³ / 17.5kg / 1pcs	€ 376,00
■ TKITT03._/BG4J.10		0.18m³ / 17.5kg / 1pcs	€ 205,00

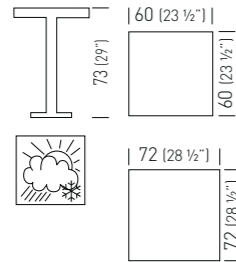
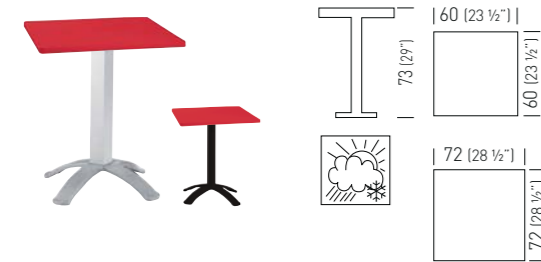

■ TKITT20._/BG4J		0.16m³ / 17.6kg / 1pcs	€ 366,00
■ TKITT20._/BG4J.10		0.16m³ / 17.6kg / 1pcs	€ 200,00
■ TKITT06._/BG4J		0.18m³ / 18.8kg / 1pcs	€ 408,00
■ TKITT06._/BG4J.10		0.18m³ / 18.8kg / 1pcs	€ 448,00

■ TKITT23._/BG4J		0.19m³ / 21.4kg / 1pcs	€ 426,00
■ TKITT23._/BG4J.10		0.19m³ / 21.4kg / 1pcs	€ 466,00

TKITT.BGPK

H75 folding table with technopolymer top, BG4J 4-spur metal-technopolymer co-injected base, Ø 80mm anodized aluminum column with flip-top mechanism.

Tavolo pieghevole con piano in tecnopolimero H75, basamento BGPK a quattro razze in metallo sovrastampato con tecnopolimero, colonna in alluminio anodizzato Ø 80mm.

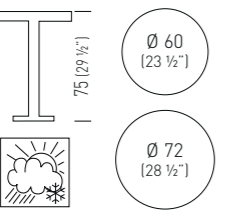
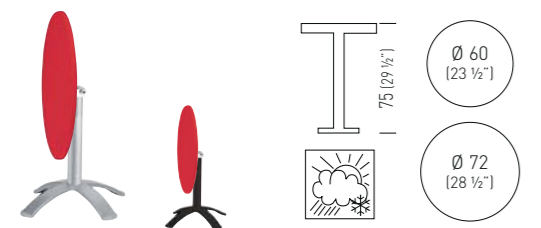

■ TKITT04._/BGPK		0.13m³ / 17.5kg / 1pcs	€ 486,00
■ TKITT04._/BGPK.10		0.13m³ / 17.5kg / 1pcs	€ 534,00
■ TKITT03._/BGPK		0.15m³ / 18.2kg / 1pcs	€ 514,00
■ TKITT03._/BGPK.10		0.15m³ / 18.2kg / 1pcs	€ 570,00

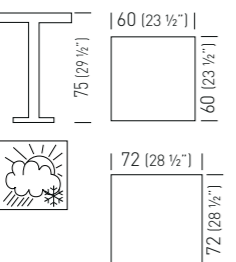
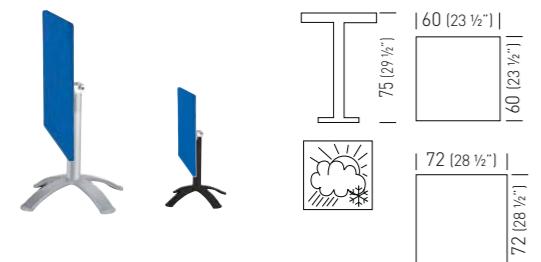

■ TKITT20._/BGPK		0.13m³ / 18.3kg / 1pcs	€ 506,00
■ TKITT20._/BGPK.10		0.13m³ / 18.3kg / 1pcs	€ 556,00
■ TKITT06._/BGPK		0.15m³ / 19.5kg / 1pcs	€ 552,00
■ TKITT06._/BGPK.10		0.15m³ / 19.5kg / 1pcs	€ 608,00

■ TKITT23._/BGPK		0.16m³ / 22.1kg / 1pcs	€ 566,00
■ TKITT23._/BGPK.10		0.16m³ / 22.1kg / 1pcs	€ 622,00

Top Color / Colore Piano



TKITT.BGPJ

H75 folding table with technopolymer top, BG4J 4-spur metal-technopolymer co-injected base, 80x80mm anodized aluminum column with flip-top mechanism.

Tavolo pieghevole con piano in tecnopolimero H75, basamento BGPJ a quattro razze in metallo sovrastampato con tecnopolimero, colonna in alluminio anodizzato 80x80mm.

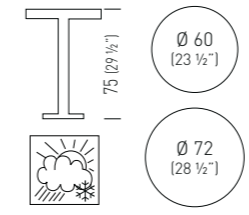
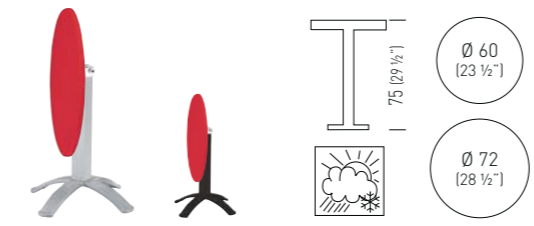

■ TKITT04._/BGPJ		0.16m³ / 17.8kg / 1pcs	€ 502,00
■ TKITT04._/BGPJ.10		0.16m³ / 17.8kg / 1pcs	€ 552,00
■ TKITT03._/BGPJ		0.18m³ / 18.5kg / 1pcs	€ 532,00
■ TKITT03._/BGPJ.10		0.18m³ / 18.5kg / 1pcs	€ 584,00

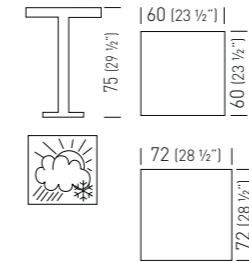
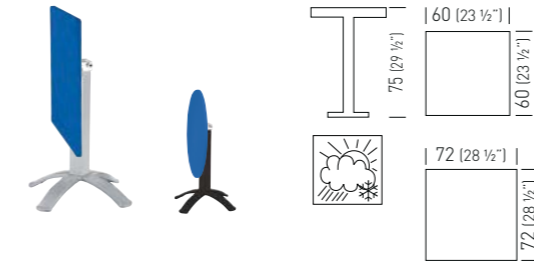

■ TKITT20._/BGPJ		0.16m³ / 18.6kg / 1pcs	€ 522,00
■ TKITT20._/BGPJ.10		0.16m³ / 18.6kg / 1pcs	€ 574,00
■ TKITT06._/BGPJ		0.18m³ / 19.8kg / 1pcs	€ 564,00
■ TKITT06._/BGPJ.10		0.18m³ / 19.8kg / 1pcs	€ 620,00

■ TKITT23._/BGPJ		0.19m³ / 22.4kg / 1pcs	€ 580,00
■ TKITT23._/BGPJ.10		0.19m³ / 22.4kg / 1pcs	€ 638,00

TKITT.BG4IP

Folding and stacking H75 table with technopolymer top, BG4IP 4-spur metal-technopolymer co-injected table base, Ø 80mm anodized aluminum column with flip-top mechanism and adjustable feet.

Tavolo pieghevole e accatastabile con piano in tecnopolimero H75, basamento BG4IP a quattro razze in metallo sovrastampato con tecnopolimero, colonna in alluminio anodizzato Ø 80mm e piedini regolabili.

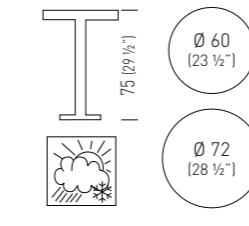
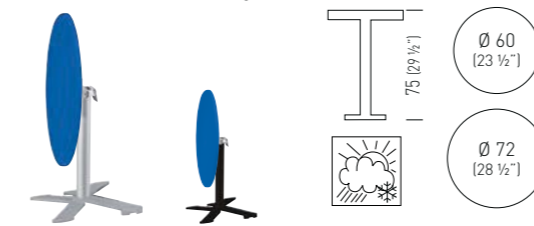

■ TKITT04._/BG4IP		0.13m³ / 14kg / 1pcs	€ 566,00
■ TKITT04._/BG4IP.10		0.13m³ / 14kg / 1pcs	€ 622,00
■ TKITT03._/BG4IP		0.15m³ / 14.7kg / 1pcs	€ 600,00
■ TKITT03._/BG4IP.10		0.15m³ / 14.7kg / 1pcs	€ 658,00

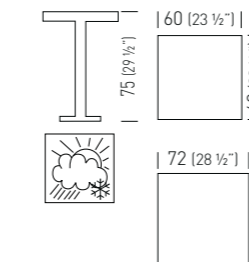
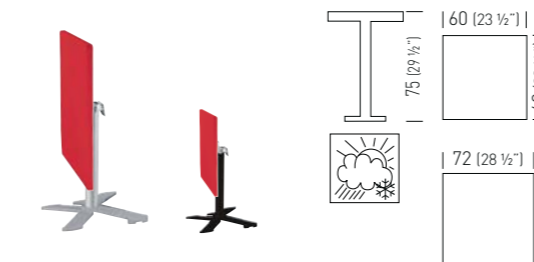

■ TKITT20._/BG4IP		0.13m³ / 14.8kg / 1pcs	€ 588,00
■ TKITT20._/BG4IP.10		0.13m³ / 14.8kg / 1pcs	€ 646,00
■ TKITT06._/BG4IP		0.15m³ / 16kg / 1pcs	€ 632,00
■ TKITT06._/BG4IP.10		0.15m³ / 16kg / 1pcs	€ 696,00

■ TKITT23._/BG4IP		0.16m³ / 18.5kg / 1pcs	€ 650,00
■ TKITT23._/BG4IP.10		0.16m³ / 18.5kg / 1pcs	€ 716,00

Top Color / Colore Piano

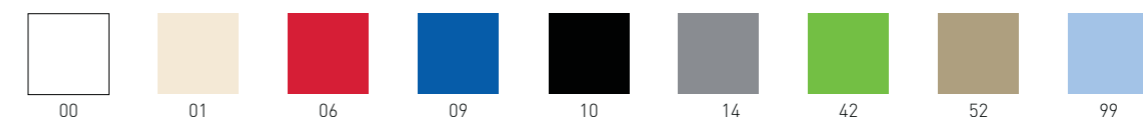

TKITT.BTK

H75 Table with technopolymer top, round BTK metal-technopolymer co-injected base, Ø 80mm anodized aluminum column.

Tavolo con piano in tecnopolimero H75, basamento BTK rotondo in metallo sovrastampato con tecnopolimero, colonna in alluminio anodizzato Ø 80mm.

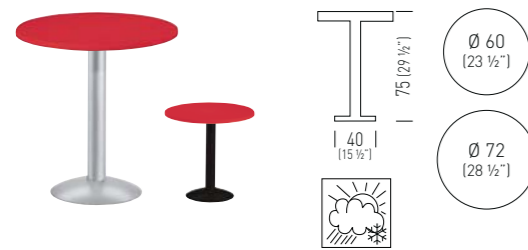

■ TKITT04._/BTK		0.16m³ / 13.8kg / 1pcs	€	276,00
■ TKITT04._/BTK.10		0.16m³ / 13.8kg / 1pcs	€	304,00
■ TKITT03._/BTK		0.18m³ / 14.5kg / 1pcs	€	304,00
■ TKITT03._/BTK.10		0.18m³ / 14.5kg / 1pcs	€	336,00

TKITT.BTK54

H75 Table with technopolymer top, round BTK54 metal-technopolymer co-injected table base, Ø 80mm anodized aluminum column.

Tavolo con piano in tecnopolimero H75, basamento BTK54 rotondo in metallo sovrastampato con tecnopolimero, colonna in alluminio anodizzato Ø 80mm.

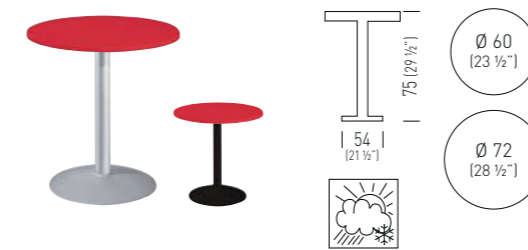

■ TKITT04._/BTK54		0.16m³ / 16.3kg / 1pcs	€	312,00
■ TKITT04._/BTK54.10		0.16m³ / 16.3kg / 1pcs	€	342,00
■ TKITT03._/BTK54		0.18m³ / 17kg / 1pcs	€	338,00
■ TKITT03._/BTK54.10		0.18m³ / 17kg / 1pcs	€	372,00

TKITT.BTAK

H110 Table with technopolymer top, round BTAK metal-technopolymer co-injected base, Ø 80mm anodized aluminum column.

Tavolo con piano in tecnopolimero H110, basamento BTAK rotondo in metallo sovrastampato con tecnopolimero, colonna in alluminio anodizzato Ø 80mm.

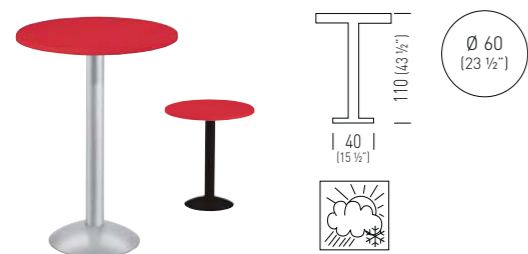

■ TKITT04._/BTAK		0.17m³ / 14.8kg / 1pcs	€	338,00
■ TKITT04._/BTAK.10		0.17m³ / 14.8kg / 1pcs	€	372,00

TKITT.BTAK54

H110 Table with technopolymer top, round BTK54 metal-technopolymer co-injected table base, Ø 80mm anodized aluminum column.

Tavolo con piano in tecnopolimero H110, basamento BTAK54 rotondo in metallo sovrastampato con tecnopolimero, colonna in alluminio anodizzato Ø 80mm.

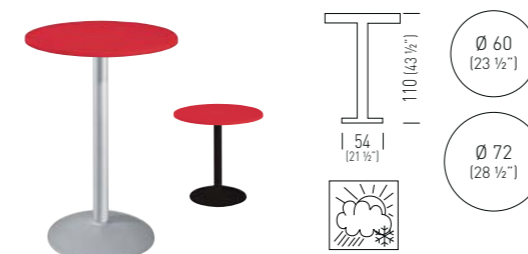

■ TKITT04._/BTAK54		0.17m³ / 17.3kg / 1pcs	€	378,00
■ TKITT04._/BTAK54.10		0.17m³ / 17.3kg / 1pcs	€	414,00
■ TKITT03._/BTAK54		0.19m³ / 18kg / 1pcs	€	404,00
■ TKITT03._/BTAK54.10		0.19m³ / 18kg / 1pcs	€	448,00

Top Color / Colore Piano



Top Color / Colore Piano



TKITT.DPBT54

H110 double table with technopolymer tops, round DPBT54 metal-technopolymer co-injected base, Ø 80mm anodized aluminum column.

Tavolo con doppio piano in tecnopolimero H110, basamento DPBT54 rotondo in metallo sovrastampato con tecnopolimero, colonna in alluminio anodizzato Ø 80mm.

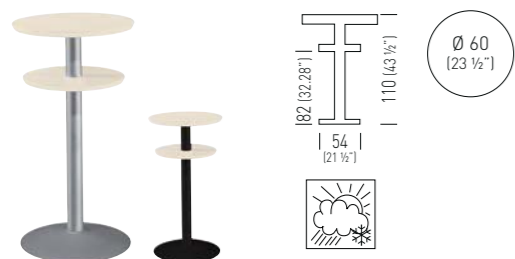

■ TKITT08._/DPBT54		0.15m³ / 16.5kg / 1pcs	€	468,00
■ TKITT08._/DPBT54.10		0.15m³ / 16.5kg / 1pcs	€	512,00

TKITT.BRK

H75 Table with technopolymer top, round BRK metal-technopolymer co-injected base, Ø 80mm anodized aluminum column.

Tavolo con piano in tecnopolimero H75, basamento BRK rotondo in metallo sovrastampato con tecnopolimero, colonna in alluminio anodizzato Ø 80mm.

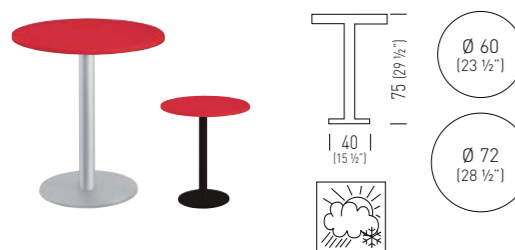

■ TKITT04._/BRK		0.13m³ / 14.3kg / 1pcs	€	284,00
■ TKITT04._/BRK.10		0.13m³ / 14.3kg / 1pcs	€	312,00
■ TKITT03._/BRK		0.15m³ / 15kg / 1pcs	€	312,00
■ TKITT03._/BRK.10		0.15m³ / 15kg / 1pcs	€	342,00

Top Color / Colore Piano



TKITT.BQJ

H74 Table with technopolymer top, square BQJ metal-technopolymer co-injected table base, 80x80mm anodized aluminum column.

Tavolo con piano in tecnopolimero H74, basamento BQJ quadrato in metallo sovrastampato con tecnopolimero, colonna in alluminio anodizzato 80x80mm.

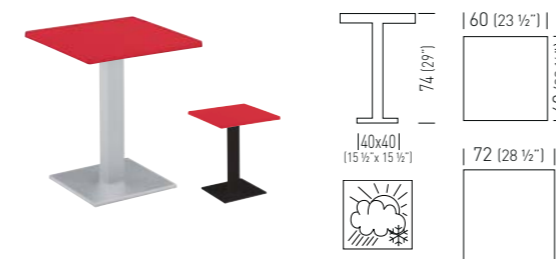

■ TKITT20._/BQJ		0.13m³ / 17.1kg / 1pcs	€	322,00
■ TKITT20._/BQJ.10		0.13m³ / 17.1kg / 1pcs	€	352,00
■ TKITT06._/BQJ		0.15m³ / 18.3kg / 1pcs	€	368,00
■ TKITT06._/BQJ.10		0.15m³ / 18.3kg / 1pcs	€	402,00

TKITT.BQAJ

H103 Table with technopolymer top, square BQJ metal-technopolymer co-injected table base, 80x80mm anodized aluminum column.

Tavolo con piano in tecnopolimero H103, basamento BQJ quadrato in metallo sovrastampato con tecnopolimero, colonna in alluminio anodizzato 80x80mm.

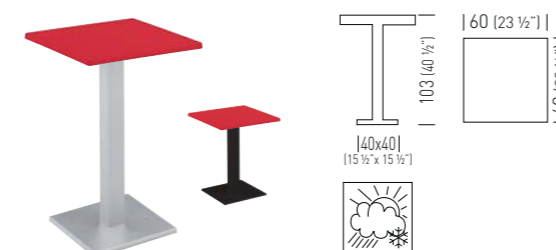

■ TKITT20._/BQAJ		0.14m³ / 17.6kg / 1pcs	€	396,00
■ TKITT20._/BQAJ.10		0.14m³ / 17.6kg / 1pcs	€	436,00

Top Color / Colore Piano



TIMPT.STAKY

Stackable table collection, suitable for outdoor use.
Techno polymer tops and anodized aluminum frames.

Collezione di tavoli impilabili, adatti all'uso esterno.
I tavoli sono realizzati con piani in tecnopolimero e struttura in alluminio anodizzato.

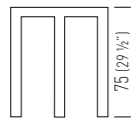

TIMPT04._/H75

0.08m³ / 7.1kg / 1pcs € **236,00**

TIMPT03._/H75

0.08m³ / 7.3kg / 1pcs € **244,00**

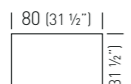
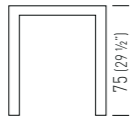

TIMPT20._/H75

0.05m³ / 7.6kg / 1pcs € **286,00**

TIMPT23._/H75

0.09m³ / 8kg / 1pcs € **336,00**

Top Color / Colore Piano



TCONT.STEADY

Counterbalanced tables collection, suitable for outdoor use.
Techno polymer tops and anodized aluminum frames.

Collezione di tavoli a contrappesi, adatti all'uso esterno.
I tavoli sono realizzati con piani in tecnopolimero e struttura in alluminio anodizzato.



TCONT06._/H75

0.08m³ / 12.8kg / 1pcs € **336,00**



TCONT23._/H75

0.10m³ / 13kg / 1pcs € **366,00**



TCONT03._/H75

0.08m³ / 12.6kg / 1pcs € **310,00**

Top Color / Colore Piano



Standard Compactop Surfaces



Flat black edge
Bordo piatto nero

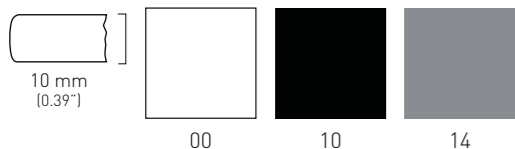

Sizes / Misure	Code / Codice	Icon	€	Sizes / Misure	Code / Codice	Icon	€
Ø 60 (23 ½")	PTC101._		256,00	Ø 80 (31 ½")	PTC105._		356,00
Ø 68 (27")	PTC103._		306,00	Ø 100 (39 ½")	PTC108._		548,00
59x59 (23"x23")	PTC102._		202,00	Ø 120 (47")	PTC109._		764,00
68x68 (27"x27")	PTC104._		236,00	Ø 140 (55")	PTC115._		778,00
79x79 (31"x31")	PTC106._		266,00	120x50 (47"x19 ½")	PTC110._		380,00
89x89 (35"x35")	PTC107._		360,00	140x70 (55"x27 ½")	PTC111._		522,00
				120x80 (47"x31 ½")	PTC112._		502,00
				159x79 (62 ½"x31")	PTC114._		578,00

ABOUT COMPACTOP: MUCH MORE THAN A MERE SURFACE

Gaber Compactops are made of high-pressure laminate, consisting of numerous layers of paper saturated with thermosetting resins and bonded through the combined action of heat and high pressure. The paper used on Compactop (around 70% of the complete composition) comes from production processes that conform with the FSC chain of custody; phenolic and melamine resins are all strictly water-based.

The result is a stable, non-reactive, homogenous, non-porous, antistatic, high-density product with a totally distinct physical and chemical profile from that of its constituent parts. Thanks to the heat and high-pressure treatment it they undergo, Gaber Compactops are exceptionally tough and resistant to scratches, abrasions, chemicals and heat, making them ideal for a wide range of contract applications. Tops come pre-bored for Gaber kit bases.

Gaber Compactops conform to EN 438/1. According to this norm, the most important characteristics of Gaber Compactops are: their resistance to bumps, scratches, and wear and tear; color-fastness; easy cleanability; suitable for contact with food and general hygiene.

UNI EN 438 is the reference standard for Compactop Gaber tops. This standard prescribes tolerances in the flatness of the product and on possible stains and other similar surface defects, for which the admissible size is based on a maximum contamination area equivalent to 1mm² / m² of laminate, concentrated in a single point or distributed in more points, proportional to the size of the sheet under inspection.

MAINTENANCE & CLEANING

No specific maintenance other than normal cleaning is required. The compact, non porous surface can easily be cleaned and disinfected with hot water, steam and any common non-abrasive household detergents and disinfectants, as long as these are not highly alkaline. Just a couple of precautions are necessary: avoid using strong acids and bases and avoid wiping with highly abrasive substances or equipment.

CHE COS'È IL COMPACTOP? MOLTO PIÙ DI UNA SEMPLICE SUPERFICIE

Il Compactop che Gaber utilizza per i propri tavoli è un laminato realizzato ad alta pressione, costituito da numerosi strati di carta impregnati con resine termoindurenti fenoliche e melaminiche, compattati attraverso l'azione combinata di calore ed alta pressione. Le carte utilizzate (circa il 70% della composizione dei piani) derivano da processi che seguono il protocollo della catena di custodia certificata FSC; le resine fenoliche e melaminiche sono tutte rigorosamente realizzate su base acqua.

Il risultato è un prodotto stabile, non reattivo, omogeneo, non poroso, antistatico e di alta densità. Grazie al trattamento di alta temperatura e pressione cui è sottoposto, il Compactop è un materiale estremamente robusto: resistente a graffi, urti, abrasioni, sostanze chimiche e calore; caratteristiche che lo rendono il materiale ideale per una vasta gamma di applicazioni. I fissaggi dei piani Compactop sono già predisposti per i basamenti Gaber.

Il Compactop è conforme alla norma EN 438/1, secondo la quale, queste sono le principali caratteristiche di qualità di questo materiale: Resistente all'impatto, ai graffi e all'usura, stabile alla luce, facile da pulire, igienico, adatto al contatto con i cibi.

La UNI EN 438 è la norma di riferimento dei piani in Compactop Gaber. Tale normativa prescrive tolleranze nella planarità del prodotto e su possibili macchie e altri difetti superficiali simili, per i quali la dimensione ammissibile è basata su un'area di contaminazione massima equivalente a 1mm²/m² di laminato, concentrata in un unico punto o dispersa in più punti, proporzionale alla dimensione del foglio sottoposto a ispezione.

MANUTENZIONE E PULIZIA

Il Compactop non richiede alcuna manutenzione particolare al di là della normale pulizia.

La sua superficie compatta e non porosa può essere facilmente pulita e disinfettata con acqua calda, vapore e tutti i tipi dei più comuni detergenti e disinfettanti per uso domestico, purché non alcalini. Sono necessarie solo poche precauzioni, quali l'evitare l'uso di acidi o basi forti, evitare di strofinare con sostanze o strumenti fortemente abrasivi.

Special Compactop Surfaces Fullcolor



Chamfered edge
Bordo smussato



Sizes / Misure	Code / Codice	Icon	€	Sizes / Misure	Code / Codice	Icon	€
Ø 60 (23 ½")	PTC301.00		306,00	Ø 60 (23 ½")	PTC201.00		306,00
Ø 68 (27")	PTC303.00		366,00	Ø 68 (27")	PTC203.00		366,00
Ø 80 (31 ½")	PTC305.00		426,00	Ø 80 (31 ½")	PTC205.00		426,00
Ø 100 (39 ½")	PTC308.00		944,00	Ø 100 (39 ½")	PTC208.00		944,00
Ø 120 (47")	PTC309.00		968,00	Ø 120 (47")	PTC209.00		968,00
Ø 140 (55")	PTC315.00		1.04,00	Ø 140 (55")	PTC215.00		1.04,00
59x59 (23"x23")	PTC302.00		242,00	59x59 (23"x23")	PTC202.00		242,00
68x68 (27"x27")	PTC304.00		280,00	68x68 (27"x27")	PTC204.00		280,00
79x79 (31"x31")	PTC306.00		320,00	79x79 (31"x31")	PTC206.00		320,00
89x89 (35"x35")	PTC307.00		432,00	89x89 (35"x35")	PTC207.00		432,00
120x50 (47"x19 ½")	PTC310.00		458,00	120x50 (47"x19 ½")	PTC210.00		458,00
140x70 (55"x27 ½")	PTC311.00		624,00	140x70 (55"x27 ½")	PTC211.00		624,00
120x80 (47"x31 ½")	PTC312.00		598,00	120x80 (47"x31 ½")	PTC212.00		598,00
159x79 (62 ½"x31")	PTC314.00		694,00	159x79 (62 ½"x31")	PTC214.00		694,00

ABOUT COMPACTOP: MUCH MORE THAN A MERE SURFACE

Gaber Compactops are made of high-pressure laminate, consisting of numerous layers of paper saturated with thermosetting resins and bonded through the combined action of heat and high pressure. The paper used on Compactop (around 70% of the complete composition) comes from production processes that conform with the FSC chain of custody; phenolic and melamine resins are all strictly water-based.

The result is a stable, non-reactive, homogenous, non-porous, antistatic, high-density product with a totally distinct physical and chemical profile from that of its constituent parts. Thanks to the heat and high-pressure treatment it they undergo, Gaber Compactops are exceptionally tough and resistant to scratches, abrasions, chemicals and heat, making them ideal for a wide range of contract applications. Tops come pre-bored for Gaber kit bases.

Gaber Compactops conform to EN 438/1. According to this norm, the most important characteristics of Gaber Compactops are: their resistance to bumps, scratches, and wear and tear; color-fastness; easy cleanability; suitable for contact with food and general hygiene.

UNI EN 438 is the reference standard for Compactop Gaber tops. This standard prescribes tolerances in the flatness of the product and on possible stains and other similar surface defects, for which the admissible size is based on a maximum contamination area equivalent to 1mm² / m² of laminate, concentrated in a single point or distributed in more points, proportional to the size of the sheet under inspection.

MAINTENANCE & CLEANING

No specific maintenance other than normal cleaning is required. The compact, non porous surface can easily be cleaned and disinfected with hot water, steam and any common non-abrasive household detergents and disinfectants, as long as these are not highly alkaline. Just a couple of precautions are necessary: avoid using strong acids and bases and avoid wiping with highly abrasive substances or equipment.

CHE COS'È IL COMPACTOP? MOLTO PIÙ DI UNA SEMPLICE SUPERFICIE

Il Compactop che Gaber utilizza per i propri tavoli è un laminato realizzato ad alta pressione, costituito da numerosi strati di carta impregnati con resine termoindurenti fenoliche e melaminiche, compattati attraverso l'azione combinata di calore ed alta pressione. Le carte utilizzate (circa il 70% della composizione dei piani) derivano da processi che seguono il protocollo della catena di custodia certificata FSC; le resine fenoliche e melaminiche sono tutte rigorosamente realizzate su base acqua.

Il risultato è un prodotto stabile, non reattivo, omogeneo, non poroso, antistatico e di alta densità. Grazie al trattamento di alta temperatura e pressione cui è sottoposto, il Compactop è un materiale estremamente robusto: resistente a graffi, urti, abrasioni, sostanze chimiche e calore; caratteristiche che lo rendono il materiale ideale per una vasta gamma di applicazioni. I fissaggi dei piani Compactop sono già predisposti per i basamenti Gaber.

Il Compactop è conforme alla norma EN 438/1, secondo la quale, queste sono le principali caratteristiche di qualità di questo materiale: Resistente all'impatto, ai graffi e all'usura, stabile alla luce, facile da pulire, igienico, adatto al contatto con i cibi.

La UNI EN 438 è la norma di riferimento dei piani in Compactop Gaber. Tale normativa prescrive tolleranze nella planarità del prodotto e su possibili macchie e altri difetti superficiali simili, per i quali la dimensione ammissibile è basata su un'area di contaminazione massima equivalente a 1mm²/m² di laminato, concentrata in un unico punto o dispersa in più punti, proporzionale alla dimensione del foglio sottoposto a ispezione.

MANUTENZIONE E PULIZIA

Il Compactop non richiede alcuna manutenzione particolare al di là della normale pulizia.

La sua superficie compatta e non porosa può essere facilmente pulita e disinfettata con acqua calda, vapore e tutti i tipi dei più comuni detergenti e disinfettanti per uso domestico, purché non alcalini. Sono necessarie solo poche precauzioni, quali l'evitare l'uso di acidi o basi forti, evitare di strofinare con sostanze o strumenti fortemente abrasivi.

Special Compactop Surfaces

10



Flat black edge
Bordo piatto nero

10 mm
(0.39")

(min. 20pcs each code)
(min. 20pcs per codice)

Solid

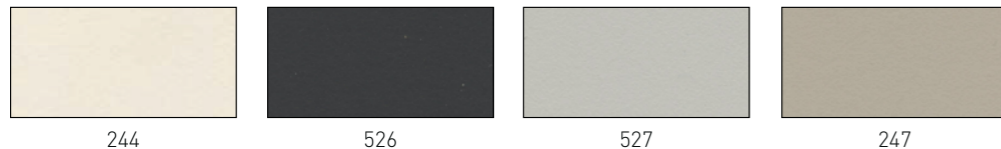

Stone, Concrete effect

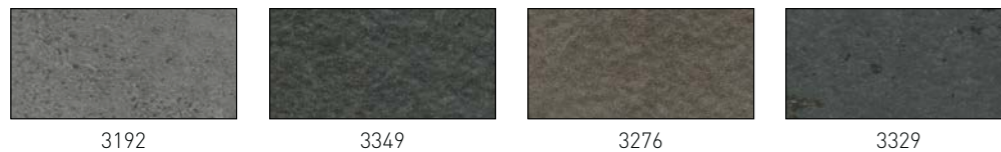

Wood effect



Marble effect

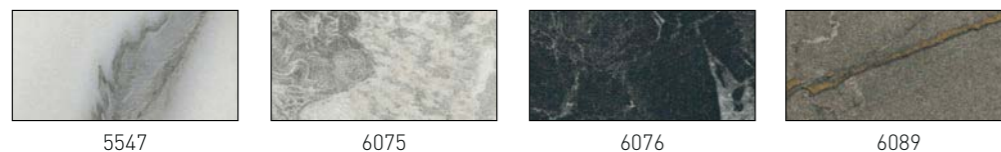

	Sizes / Misure	Code / Codice		€
	Ø 60 (23 1/2")	PTC501. __	0.700m³ / 95kg / 20pcs	256,00
	Ø 68 (27")	PTC503. __	0.700m³ / 120kg / 20pcs	306,00
	Ø 80 (31 1/2")	PTC505. __	0.84m³ / 185kg / 20pcs	356,00
	Ø 100 (39 1/2")	PTC508. __	1.20m³ / 285kg / 20pcs	548,00
	Ø 120 (47")	PTC509. __	1.20m³ / 405kg / 20pcs	764,00
	Ø 140 (55")	PTC515. __	1.60m³ / 535kg / 20pcs	778,00
	59x59 (23"x23")	PTC502. __	0.700m³ / 115kg / 20pcs	202,00
	68x68 (27"x27")	PTC504. __	0.700m³ / 155kg / 20pcs	236,00
	79x79 (31"x31")	PTC506. __	0.840m³ / 195kg / 20pcs	266,00
	89x89 (35"x35")	PTC507. __	0.840m³ / 245kg / 20pcs	360,00
	120x50 (47"x19 1/2")	PTC510. __	0.84m³ / 225kg / 20pcs	380,00
	140x70 (55"x27 1/2")	PTC511. __	0.95m³ / 355kg / 20pcs	522,00
	120x80 (47"x31 1/2")	PTC512. __	0.84m³ / 345kg / 20pcs	502,00
	159x79 (62 1/2"x31")	PTC514. __	1.20m³ / 455kg / 20pcs	578,00

ABOUT COMPACTOP: MUCH MORE THAN A MERE SURFACE

Gaber Compactops are made of high-pressure laminate, consisting of numerous layers of paper saturated with thermosetting resins and bonded through the combined action of heat and high pressure. The paper used on Compactop (around 70% of the complete composition) comes from production processes that conform with the FSC chain of custody; phenolic and melamine resins are all strictly water-based. The result is a stable, non-reactive, homogenous, non-porous, antistatic, high-density product with a totally distinct physical and chemical profile from that of its constituent parts. Thanks to the heat and high-pressure treatment it they undergo, Gaber Compactops are exceptionally tough and resistant to scratches, abrasions, chemicals and heat, making them ideal for a wide range of contract applications. Tops come pre-bored for Gaber kit bases. Gaber Compactops conform to EN 438/1. According to this norm, the most important characteristics of Gaber Compactops are: their resistance to bumps, scratches, and wear and tear; color-fastness; easy cleanability; suitable for contact with food and general hygiene. UNI EN 438 is the reference standard for Compactop Gaber tops. This standard prescribes tolerances in the flatness of the product and on possible stains and other similar surface defects, for which the admissible size is based on a maximum contamination area equivalent to 1mm² / m² of laminate, concentrated in a single point or distributed in more points, proportional to the size of the sheet under inspection.

MAINTENANCE & CLEANING

No specific maintenance other than normal cleaning is required. The compact, non porous surface can easily be cleaned and disinfected with hot water, steam and any common non-abrasive household detergents and disinfectants, as long as these are not highly alkaline. Just a couple of precautions are necessary: avoid using strong acids and bases and avoid wiping with highly abrasive substances or equipment.

CHE COS'È IL COMPACTOP? MOLTO PIÙ DI UNA SEMPLICE SUPERFICIE

Il Compactop che Gaber utilizza per i propri tavoli è un laminato realizzato ad alta pressione, costituito da numerosi strati di carta impregnati con resine termoindurenti fenoliche e melaminiche, compattati attraverso l'azione combinata di calore ed alta pressione. Le carte utilizzate (circa il 70% della composizione dei piani) derivano da processi che seguono il protocollo della catena di custodia certificata FSC; le resine fenoliche e melaminiche sono tutte rigorosamente realizzate su base acquosa. Il risultato è un prodotto stabile, non reattivo, omogeneo, non poroso, antistatico e di alta densità. Grazie al trattamento di alta temperatura e pressione cui è sottoposto, il Compactop è un materiale estremamente robusto: resistente a graffi, urti, abrasioni, sostanze chimiche e calore; caratteristiche che lo rendono il materiale ideale per una vasta gamma di applicazioni. I fissaggi dei piani Compactop sono già predisposti per i basamenti Gaber. Il Compactop è conforme alla norma EN 438/1, secondo la quale, queste sono le principali caratteristiche di qualità di questo materiale: Resistente all'impatto, ai graffi e all'usura, stabile alla luce, facile da pulire, igienico, adatto al contatto con i cibi.

La UNI EN 438 è la norma di riferimento dei piani in Compactop Gaber. Tale normativa prescrive tolleranze nella planarità del prodotto e su possibili macchie e altri difetti superficiali simili, per i quali la dimensione ammissibile è basata su un'area di contaminazione massima equivalente a 1mm²/m² di laminato, concentrata in un unico punto o dispersa in più punti, proporzionale alla dimensione del foglio sottoposto a ispezione.

MANUTENZIONE E PULIZIA

Il Compactop non richiede alcuna manutenzione particolare al di là della normale pulizia. La sua superficie compatta e non porosa può essere facilmente pulita e disinfettata con acqua calda, vapore e tutti i tipi dei più comuni detergenti e disinfettanti per uso domestico, purché non alcalini. Sono necessarie solo poche precauzioni, quali l'evitare l'uso di acidi o basi forti, evitare di strofinare con sostanze o strumenti fortemente abrasivi.

Special Compactop Surfaces Fenix

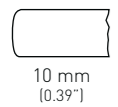

Flat black edge
Bordo piatto nero

(min. 20pcs each code)
(min. 20pcs per codice)

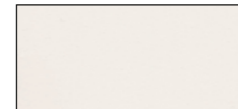

0029



0720

	Sizes / Misure	Code / Codice		€
○	Ø 60 (23 ½")	PTC401.__	0.70m³ / 95kg / 20pcs	306,00
	Ø 68 (27")	PTC403.__	0.70m³ / 120kg / 20pcs	366,00
□	59x59 (23"x23")	PTC402.__	0.70m³ / 115kg / 20pcs	242,00
	68x68 (27"x27")	PTC404.__	0.70m³ / 155kg / 20pcs	280,00
	79x79 (31"x31")	PTC406.__	0.84m³ / 195kg / 20pcs	320,00
	89x89 (35"x35")	PTC407.__	0.84m³ / 245kg / 20pcs	434,00

ABOUT FENIX COMPACTOP

Gaber's Fenix Compactop differ from standards as they are built with new generation materials on exposed coated surfaces, made using nanoparticles and acrylic resins. This coating avoid fingerprints on the material, make it soft-touch, heat-repairing, opaque and extremely resistant to bumps and scratches. In addition to this, the material is water repellent, hygienic, easy to clean and suitable for food-contact.

MAINTENANCE & CLEANING

No specific maintenance other than normal cleaning is required. The compact, non porous surface can easily be cleaned and disinfected with a soft cloth dampened with hot water, steam and any common non-abrasive household detergents and disinfectants, as long as these are not highly alkaline. Just a couple of precautions are necessary: avoid using strong acids and bases and avoid wiping with highly abrasive substances or equipment.

CHE COS'È IL FENIX COMPACTOP

I piani Compactop Fenix di Gaber differiscono dagli standard in quanto prevedono l'utilizzo delle superfici esposte rivestite con materiali di nuova generazione, realizzati per mezzo dell'uso di nanoparticelle e resine acriliche. Tali rivestimenti rendono il materiale anti-impronta, morbido al tatto, termo-riparatore, opaco ed estremamente resistente ad urti e graffi. Oltre a ciò, il materiale è idrorepellente, igienico, resistente alle muffe, facile da pulire e adatto al contatto con alimenti.

MANUTENZIONE E PULIZIA

Il Compactop non richiede alcuna manutenzione particolare al di là della normale pulizia.

La sua superficie compatta e non porosa può essere facilmente pulita e disinfettata con un panno umido, acqua calda, vapore e tutti i tipi dei più comuni detergenti e disinfettanti per uso domestico, purché non alcalini. Sono necessarie solo poche precauzioni, quali l'evitare l'uso di acidi o basi forti, evitare di strofinare con sostanze o strumenti fortemente abrasivi.

Standard Laminated Surfaces 22

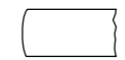

22 mm
(0.86")



F



W



RN



00

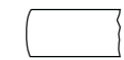

25 mm
(0.98")



10

Bottom surfaces of our laminated tops are in white, black or dark grey colors. Il fondo del piano laminato può essere con colore bianco, nero o grigio antracite.

For orders under 10no. surcharge 20€ each unit
Per ordini inferiori ai 10pz + €20,00 ogni unità.

	Sizes / Misure	Code / Codice		€
○	Ø 60 (23 ½")	PTL101.__	0.054m³ / 11kg / 2pcs	172,00
	Ø 70 (27 ½")	PTL103.__	0.074m³ / 13kg / 2pcs	218,00
	Ø 80 (31 ½")	PTL105.__	0.090m³ / 14kg / 2pcs	304,00
	Ø 90 (35 ½")	PTL127.__	0.110m³ / 16kg / 2pcs	352,00
	Ø 100 (39 ½")	PTL108.__	0.200m³ / 20kg / 2pcs	498,00
	Ø 120 (47")	PTL109.__	0.260m³ / 27kg / 2pcs	580,00
□	Ø 140 (55")	PTL115.__	0.300m³ / 33kg / 2pcs	702,00
	60x60 (23 ½"x23 ½")	PTL102.__	0.054m³ / 13kg / 2pcs	158,00
	70x70 (27 ½"x27 ½")	PTL104.__	0.074m³ / 19kg / 2pcs	172,00
	80x80 (31 ½"x31 ½")	PTL106.__	0.090m³ / 24kg / 2pcs	194,00
	90x90 (35 ½"x35 ½")	PTL107.__	0.110m³ / 27kg / 2pcs	238,00
	100x100 (39 ½"x39 ½")	PTL128.__	0.200m³ / 28kg / 2pcs	364,00
□	120x50 (47"x19 ½")	PTL110.__	0.110m³ / 27kg / 2pcs	242,00
	120x80 (47"x31 ½")	PTL112.__	0.200m³ / 30kg / 2pcs	256,00
	140x70 (55"x27 ½")	PTL111.__	0.200m³ / 34kg / 2pcs	282,00
	160x80 (63"x31 ½")	PTL114.__	0.260m³ / 36kg / 2pcs	432,00

ABOUT LAMINATED TABLE TOPS

Gaber's laminate table tops are composed of a high-pressure decorative laminate layer, with a recycled-wood chipboard core and ABS edging. Gaber's support materials are E1 according to tests stipulated by the European standards EN717 and EN120 regarding formaldehyde emission. Laminate tops come ready for Gaber kit bases.

The result is homogeneous, static, lightweight and highly customizable in terms of shapes and finishes.

Our laminate tops are manufactures according the following European Standards related to fire reaction: EN 13501-1:2009 B -s2, d0.

MAINTENANCE & CLEANING

Gaber laminated table tops do not require any special maintenance beyond normal cleaning.

Laminated surfaces can be easily cleaned with a soft cloth dampened with water, even with cleaning agents, but not alkaline and generally aggressive. Avoid the use of strong acids or bases, avoid wiping with abrasive substances or equipment.

COSA SONO I PIANI DEI TAVOLI IN LAMINATO?

I ripiani laminati che Gaber utilizza per i propri tavoli sono composti da uno strato di laminato decorativo ad alta pressione, supportato da un pannello di truciolare; quest'ultimo realizzato con i materiali di scarto delle normali lavorazioni del legno. I piani sono bordati con bordo in Abs. La tipologia di supporto utilizzato da Gaber per i propri piani è di classe E1 secondo i test espressi dalle normative europee EN717 e EN120 in materia di emissione di formaldeide. I fissaggi dei ripiani in Laminato sono già predisposti per i basamenti Gaber.

Il risultato è un prodotto omogeneo, antistatico, leggero e facilmente personalizzabile in forme e finiture.

I nostri piani in laminato sono realizzati secondo la normativa europea di reazione al fuoco EN 13501-1:2009 B -s2, d0.

MANUTENZIONE E PULIZIA

I piani Laminati di Gaber non richiedono alcuna manutenzione particolare al di là della normale pulizia.

La sua superficie può essere facilmente pulita con un panno morbido imbevuto di acqua, anche con detergenti per uso domestico, purché non alcalini ed in genere aggressivi. Evitare l'uso di acidi o basi forti, evitare di strofinare con sostanze o strumenti abrasivi.

Standard Laminated Surfaces

50



Bottom surfaces of our laminated tops are in white, black or dark grey colors. Il fondo del piano laminato può essere con colore bianco, nero o grigio antracite.

50 mm (1.96")
20 mm
42 mm



For orders under 10no. surcharge 20€ each unit
Per ordini inferiori ai 10pz + €20,00 ogni unità.

Sizes / Misure	Code / Codice		€
60x60 (23 1/2"x23 1/2")	PTL202. __	0.054m³ / 7kg / 1pcs	152,00
70x70 (27 1/2"x27 1/2")	PTL204. __	0.074m³ / 9kg / 1pcs	242,00
80x80 (31 1/2"x31 1/2")	PTL206. __	0.090m³ / 13kg / 1pcs	320,00
90x90 (35 1/2"x35 1/2")	PTL207. __	0.110m³ / 15kg / 1pcs	346,00
100x100 (39 1/2"x39 1/2")	PTL228. __	0.200m³ / 16kg / 1pcs	412,00
120x80 (47"x31 1/2")	PTL212. __	0.200m³ / 17kg / 1pcs	348,00

ABOUT LAMINATED TABLE TOPS

Gaber's laminate table tops are composed of a high-pressure decorative laminate layer, with a recycled-wood chipboard core and ABS edging. Gaber's support materials are E1 according to tests stipulated by the European standards EN717 and EN120 regarding formaldehyde emission. Laminate tops come ready for Gaber kit bases.

The result is homogeneous, static, lightweight and highly customizable in terms of shapes and finishes.

Our laminate tops are manufactured according to the following European Standards related to fire reaction: EN 13501-1:2009 B -s2, d0.

MAINTENANCE & CLEANING

Gaber laminated table tops do not require any special maintenance beyond normal cleaning.

Laminated surfaces can be easily cleaned with a soft cloth dampened with water, even with cleaning agents, but not alkaline and generally aggressive. Avoid the use of strong acids or bases, avoid wiping with abrasive substances or equipment.

COSA SONO I PIANI DEI TAVOLI IN LAMINATO?

I ripiani laminati che Gaber utilizza per i propri tavoli sono composti da uno strato di laminato decorativo ad alta pressione, supportato da un pannello di truciolare; quest'ultimo realizzato con i materiali di scarto delle normali lavorazioni del legno. I piani sono bordati con bordo in Abs. La tipologia di supporto utilizzato da Gaber per i propri piani è di classe E1 secondo i test espressi dalle normative europee EN717 e EN120 in materia di emissione di formaldeide. I fissaggi dei ripiani in Laminato sono già predisposti per i basamenti Gaber.

Il risultato è un prodotto omogeneo, antistatico, leggero e facilmente personalizzabile in forme e finiture.

I nostri piani in laminato sono realizzati secondo la normativa europea di reazione al fuoco EN 13501-1:2009 B -s2, d0.

MANUTENZIONE E PULIZIA

I piani Laminati di Gaber non richiedono alcuna manutenzione particolare al di là della normale pulizia.

La sua superficie può essere facilmente pulita con un panno morbido imbevuto di acqua, anche con detersivi per uso domestico, purché non alcalini ed in genere aggressivi. Evitare l'uso di acidi o basi forti, evitare di strofinare con sostanze o strumenti abrasivi.

Special Laminated Surfaces

Wood Effect 25



25 mm (0.98") (min. 20pcs each code) (min. 20pcs per codice)

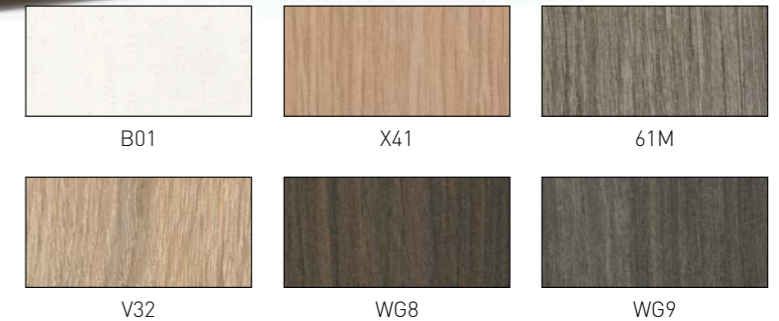

Sizes / Misure	Code / Codice		€
Ø 60 (23 1/2")	PTL301. __	0.700m³ / 85kg / 20pcs	196,00
Ø 70 (27 1/2")	PTL303. __	0.700m³ / 105kg / 20pcs	248,00
Ø 80 (31 1/2")	PTL305. __	0.840m³ / 125kg / 20pcs	352,00
Ø 90 (35 1/2")	PTL327. __	0.840m³ / 155kg / 20pcs	400,00
Ø 100 (39 1/2")	PTL308. __	1.200m³ / 190kg / 20pcs	546,00
Ø 120 (47")	PTL309. __	1.200m³ / 270kg / 20pcs	630,00
Ø 140 (55")	PTL315. __	1.600m³ / 325kg / 20pcs	750,00
60x60 (23 1/2"x23 1/2")	PTL302. __	0.700m³ / 95kg / 20pcs	182,00
70x70 (27 1/2"x27 1/2")	PTL304. __	0.700m³ / 125kg / 20pcs	182,00
80x80 (31 1/2"x31 1/2")	PTL306. __	0.840m³ / 160kg / 20pcs	222,00
90x90 (35 1/2"x35 1/2")	PTL307. __	0.840m³ / 195kg / 20pcs	270,00
100x100 (39 1/2"x39 1/2")	PTL328. __	1.200m³ / 235kg / 20pcs	412,00
120x50 (47"x19 1/2")	PTL310. __	0.840m³ / 155kg / 20pcs	290,00
120x80 (47"x31 1/2")	PTL312. __	0.840m³ / 235kg / 20pcs	304,00
140x70 (55"x27 1/2")	PTL311. __	0.950m³ / 240kg / 20pcs	330,00
160x80 (63"x31 1/2")	PTL314. __	1.200m³ / 300kg / 20pcs	480,00

ABOUT LAMINATED TABLE TOPS

Gaber's laminate table tops are composed of a high-pressure decorative laminate layer, with a recycled-wood chipboard core and ABS edging. Gaber's support materials are E1 according to tests stipulated by the European standards EN717 and EN120 regarding formaldehyde emission. Laminate tops come ready for Gaber kit bases.

The result is homogeneous, static, lightweight and highly customizable in terms of shapes and finishes.

To optimize the production process, sizes may vary with tolerance ± 5mm.

MAINTENANCE & CLEANING

Gaber laminated table tops do not require any special maintenance beyond normal cleaning.

Laminated surfaces can be easily cleaned with a soft cloth dampened with water, even with cleaning agents, but not alkaline and generally aggressive. Avoid the use of strong acids or bases, avoid wiping with abrasive substances or equipment.

COSA SONO I PIANI DEI TAVOLI IN LAMINATO?

I ripiani laminati che Gaber utilizza per i propri tavoli sono composti da uno strato di laminato decorativo ad alta pressione, supportato da un pannello di truciolare; quest'ultimo realizzato con i materiali di scarto delle normali lavorazioni del legno. I piani sono bordati con bordo in Abs. La tipologia di supporto utilizzato da Gaber per i propri piani è di classe E1 secondo i test espressi dalle normative europee EN717 e EN120 in materia di emissione di formaldeide. I fissaggi dei ripiani in Laminato sono già predisposti per i basamenti Gaber.

Il risultato è un prodotto omogeneo, antistatico, leggero e facilmente personalizzabile in forme e finiture.

Ad ottimizzazione delle lavorazioni, le dimensioni possono variare nella tolleranza di ± 5mm.

MANUTENZIONE E PULIZIA

I piani Laminati di Gaber non richiedono alcuna manutenzione particolare al di là della normale pulizia.

La sua superficie può essere facilmente pulita con un panno morbido imbevuto di acqua, anche con detersivi per uso domestico, purché non alcalini ed in genere aggressivi. Evitare l'uso di acidi o basi forti, evitare di strofinare con sostanze o strumenti abrasivi.

Special Laminated Surfaces

Fenix 25



25 mm (0.98") (min. 20pcs each code) (min. 20pcs per codice)

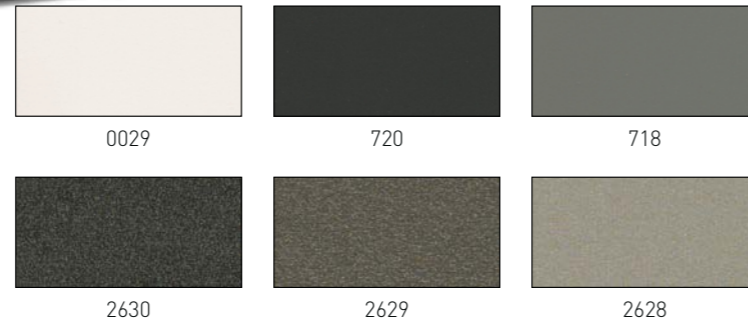

Sizes / Misure	Code / Codice		€
	Ø 60 (23 1/2")	PTL401._	0.700m³ / 85kg / 20pcs 196,00
	Ø 70 (27 1/2")	PTL403._	0.700m³ / 105kg / 20pcs 248,00
	Ø 80 (31 1/2")	PTL405._	0.840m³ / 125kg / 20pcs 352,00
	Ø 90 (35 1/2")	PTL427._	0.840m³ / 155kg / 20pcs 400,00
	Ø 100 (39 1/2")	PTL408._	1.200m³ / 190kg / 20pcs 546,00
	Ø 120 (47")	PTL409._	1.200m³ / 270kg / 20pcs 630,00
	Ø 140 (55")	PTL415._	1.600m³ / 325kg / 20pcs 750,00
	60x60 (23 1/2"x23 1/2")	PTL402._	0.700m³ / 95kg / 20pcs 182,00
	70x70 (27 1/2"x27 1/2")	PTL404._	0.700m³ / 125kg / 20pcs 198,00
	80x80 (31 1/2"x31 1/2")	PTL406._	0.840m³ / 160kg / 20pcs 222,00
	90x90 (35 1/2"x35 1/2")	PTL407._	0.840m³ / 195kg / 20pcs 270,00
	100x100 (39 1/2"x39 1/2")	PTL428._	1.200m³ / 235kg / 20pcs 412,00
	120x50 (47"x19 1/2")	PTL410._	0.840m³ / 155kg / 20pcs 290,00
	120x80 (47"x31 1/2")	PTL412._	0.840m³ / 235kg / 20pcs 304,00
	140x70 (55"x27 1/2")	PTL411._	0.950m³ / 240kg / 20pcs 330,00
	160x80 (63"x31 1/2")	PTL414._	1.200m³ / 300kg / 20pcs 480,00

ABOUT FENIX LAMINATED TABLE TOPS

Gaber's Fenix laminated table tops are composed of a decorative Fenix laminate layer, with a recycled-wood chipboard core. Tops utilize ABS edging, made using nanoparticles and acrylic resins. This coating avoid fingerprints on the material, make it soft-touch, heat-repairing, opaque and extremely resistant to bumps and scratches. In addition to this, the material is water repellent, hygienic, easy to clean and suitable for food-contact. Gaber's support materials are E1 according to tests stipulated by the European standards EN717 and EN120 regarding formaldehyde emission. Laminate tops come ready for Gaber kit bases. To optimize the production process, sizes may vary in tolerance ±5mm.

MAINTENANCE & CLEANING

Gaber laminated table tops do not require any special maintenance beyond normal cleaning. Laminated surfaces can be easily cleaned with a soft cloth dampened with water, even with cleaning agents, but not alkaline and generally aggressive. Avoid the use of strong acids or bases, avoid wiping with abrasive substances or equipment.

CHE COSA SONO I PIANI DEI TAVOLI IN LAMINATO FENIX?

I ripiani laminati che Gaber utilizza per i propri tavoli sono composti da uno strato di laminato Fenix decorativo, supportato da un pannello truciolare; quest'ultimo realizzato con i materiali di scarto delle normali lavorazioni del legno. I piani sono bordati in ABS, realizzato per mezzo dell'uso di nanoparticelle e resine acriliche. Tali rivestimenti rendono il materiale anti-impronta, morbido al tatto, termo-riparatore, opaco ed estremamente resistente ad urti e graffi. Oltre a ciò il materiale è idrorepellente, igienico, resistente alle muffe, facile da pulire e adatto al contatto con alimenti. La tipologia di supporto utilizzato da Gaber per i propri piani è di classe E1 secondo i test espressi dalle normative europee EN717 e EN120 in materia di emissione di formaldeide. I fissaggi dei ripiani in laminato sono già predisposti per i basamenti Gaber. Ad ottimizzazione delle lavorazioni, le dimensioni possono variare nella tolleranza di ±5mm.

MANUTENZIONE E PULIZIA

I piani laminati di Gaber non richiedono alcuna manutenzione particolare al di là della normale pulizia. La sua superficie può essere facilmente pulita con un panno morbido imbevuto di acqua, anche con detersivi per uso domestico, purché non alcalini ed in genere aggressivi. Evitare l'uso di acidi o basi forti, evitare di strofinare con sostanze o strumenti abrasivi.

Iron Surfaces



25 mm (0.98")

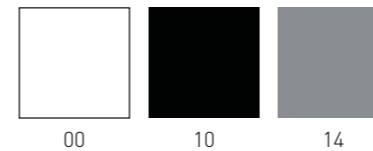

Sizes / Misure	Code / Codice		€
	60x60 (23 1/2"x23 1/2")	PTI102._	0.054m³ / 16.4kg / 2pcs 288,00
	70x70 (27 1/2"x27 1/2")	PTI104._	0.074m³ / 21.6kg / 2pcs 302,00
	80x80 (31 1/2"x31 1/2")	PTI106._	0.090m³ / 22kg / 2pcs 334,00
	120x80 (47"x31 1/2")	PTI112._	0.20m³ / 31.2kg / 2pcs 702,00

ABOUT IRON TABLE TOPS

Gaber's Iron table tops are made of composite materials: a non-deformable water-repellent multilayer wood-based core, covered in steel. The slim line result is elegant, stylish and practical. Iron tops come pre-bored for Gaber kit bases. These tough materials make iron tops suitable for indoor as well as outdoor use.

MAINTENANCE & CLEANING

Gaber's Iron table tops do not require any special maintenance beyond normal cleaning. Its surface can be easily cleaned with a soft cloth dampened with water, even with household cleaning detergent, provided they are not alkaline and generally aggressive. Avoid the use of strong acids or bases, avoid rubbing with abrasive substances or devices.

COSA SONO I PIANI DEI TAVOLI IRON?

I sistemi Iron che Gaber utilizza per i propri piani dei tavoli sono realizzati da materiali compositi: il cuore del sistema è realizzato con un materiale multistrato, a base legnosa, resistente all'umidità, di grande stabilità. Il rivestimento in acciaio e lo spessore contenuto rendono il prodotto elegante, raffinato e pratico. I fissaggi dei piani Iron sono già predisposti per i basamenti Gaber. Le finiture disponibili lo rendono adatto anche all'uso per outdoor, grazie all'ottimale resistenza agli agenti atmosferici.

MANUTENZIONE E PULIZIA



I piani Iron di Gaber non richiedono alcuna manutenzione particolare al di là della normale pulizia. La sua superficie può essere facilmente pulita con un panno morbido imbevuto di acqua, anche con detersivi per uso domestico, purché non alcalini ed in genere aggressivi. Evitare l'uso di acidi o basi forti, evitare di strofinare con sostanze o strumenti abrasivi.

Techno Polymer Table Tops

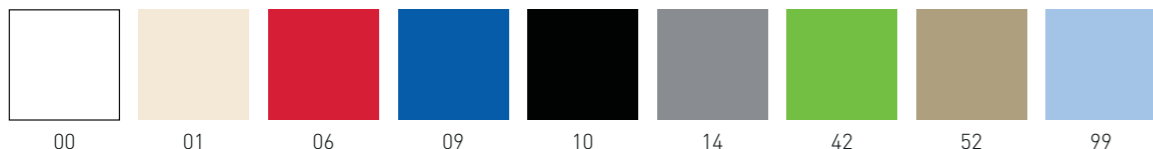

30 mm
(1.18")



	Sizes / Misure	Code / Codice		€
	Ø 60 (23 ½")	PTT04_	0.054m³ / 4kg / 1pcs	124,00
	Ø 72 (28 ½")	PTT03_	0.074m³ / 4.7kg / 1pcs	158,00
	60x60 (23 ½"X23 ½")	PTT20_	0.054m³ / 4.8kg / 1pcs	158,00
	72x72 (28 ½"X28 ½")	PTT06_	0.074m³ / 6kg / 1pcs	184,00
	80x80 (31 ½"X31 ½")	PTT23_	0.090m³ / 8.6kg / 1pcs	212,00

ABOUT TECHNO POLYMER TABLE-TOPS

The Techno Polymer Compounds Gaber uses on its table tops have high structural, heat and abrasion resistance. Gaber's technopolymer table tops are practical, shock-resistant, colorful and inexpensive.

Gaber technopolymers are non-toxic, stain-resistant, antistatic and UV-resistant and consequently have excellent resistance to atmospheric agents. All these materials are recyclable in the full respect of our Natural Environment. Gaber produces plastic injected materials without added chemicals and, as far as possible, recycled pre-used technopolymers are sourced as a base raw material. Technopolymer table top colors perfectly match the colors of Gaber's seating collection.

MAINTENANCE & CLEANING

The plastic surfaces of Gaber products can generally be cleaned with a cloth and warm water. For the most persistent stains, a small amount of liquid soap diluted in water may be used. Do not use acetone, trichloroethylene, ammonia, alcoholic substances and detergents that contain even just a small amount of these substances. We also recommend avoiding all types of abrasive and solvent substances or rough sponges.

COME SONO FATTI I RIPIANI IN TECNOPOLIMERO?

I piani in Tecnopolimero utilizzati da Gaber per i propri tavoli sono realizzati per mezzo del processo di iniezione plastica. I piani così realizzati sono pratici, resistenti agli urti, colorati ed economici. I compound di tecnopolimeri utilizzati da Gaber nella realizzazione dei propri prodotti sono caratterizzati da un'elevata resistenza strutturale, termica e all'abrasione. Il tecnopolimero è atossico, antimacchia, antistatico e anti-uv: qualità che lo rendono ottimamente resistente agli agenti atmosferici. I tecnopolimeri utilizzati da Gaber sono integralmente riciclabili, nel pieno rispetto del nostro Ambiente Naturale. Gaber produce articoli termoplastici senza additivi chimici e, ove possibile, vengono utilizzati tecnopolimeri riciclati derivanti da post-consumo. I colori dei ripiani dei tavoli corrispondono ai colori della vasta collezione di sedute Gaber.

MANUTENZIONE E PULIZIA

Le superfici in tecno polimero dei piani dei tavoli Gaber possono essere pulite con un panno umido e soffice imbevuto in acqua. Per le macchie più ostinate è possibile diluire in acqua del sapone neutro liquido con moderazione. Non utilizzare acetone, trielina, ammoniaca, sostanze alcoliche o detersivi che contengano anche piccole quantità di tali detersivi. Non utilizzare a contatto con il prodotto sostanze abrasive o solventi, strumenti di pulizia ruvidi.

TABLE BASES Collection

ARKET 3 BASE

H49-H73-H109 3 spur aluminum casted base, column made in aluminum extruded tube, aluminum cross and adjustable feet. Basamento per tavolo H49-H73-H109 con 3 razze e crociera in alluminio pressofuso, colonna in alluminio estruso. Piedini regolabili.

Top max dimensions / Massima dimensione piano



Available table tops / Piani tavolo disponibili

compactop laminated



Frame Color / Colore Struttura

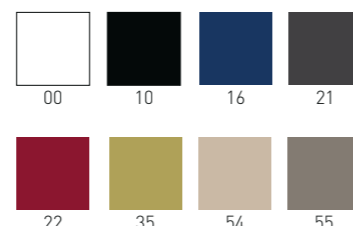

H49	BAK3B_	0.055m³ / 3.5kg / 1pcs	€ 242,00
H73	BAK3_	0.055m³ / 4.0kg / 1pcs	€ 258,00
H109	BAK3A_	0.085m³ / 4.2kg / 1pcs	€ 314,00

Minimum order 20 pcs each code, unless combined with Gaber table tops. Ordine minimo 20 pezzi per codice, se non abbinato a piani Gaber.

ARKET PLUS

H73 3 spur metal-technopolymer co-injected table base, aluminum column and cross, flip-top mechanism. Base per tavolo pieghevole H73 a tre razze in metallo sovrastampato con tecnopolimero, colonna e crociera in alluminio.

Top max dimensions / Massima dimensione piano

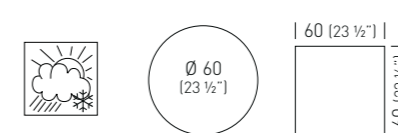

Available table tops / Piani tavolo disponibili

compactop laminated

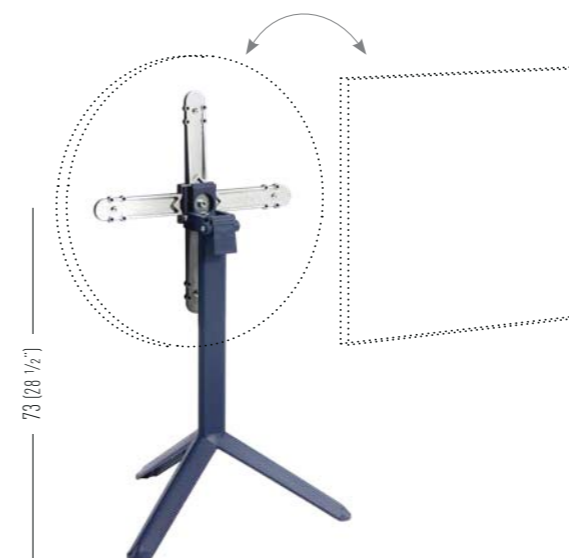

Frame Color / Colore Struttura

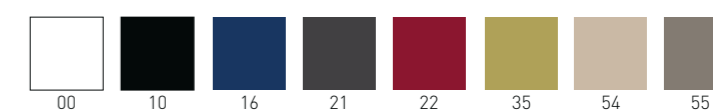

BAKP_	0.12m³ / 5.5kg / 1pc	€ 290,00
-------	----------------------	----------

ARKET 4 BASE

H49-H73-H109 4 spur aluminum casted base, column made in aluminum extruded tube, aluminum cross and adjustable feet. Basamento per tavolo H49-H73-H109 con 4 razze e crociera in alluminio pressofuso, colonna in alluminio estruso. Piedini regolabili.

Top max dimensions / Massima dimensione piano

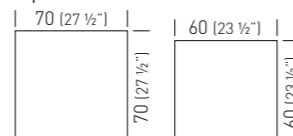

Available table tops / Piani tavolo disponibili

compactop laminated



Frame Color / Colore Struttura

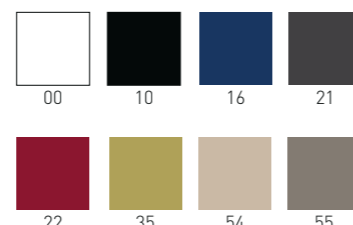

H49	BAK4B_	0.055m³ / 4.2kg / 1pcs	€ 256,00
H73	BAK4_	0.055m³ / 4.5kg / 1pcs	€ 268,00
H109	BAK4A_	0.085m³ / 4.8kg / 1pcs	€ 332,00

Minimum order 20 pcs each code, unless combined with Gaber table tops. Ordine minimo 20 pezzi per codice, se non abbinato a piani Gaber.

BG3K

H73 3-spur metal-technopolymer co-injected table base, Ø 80mm anodized aluminum column with cross. Base per tavolo H73 a tre razze in metallo sovrastampato con tecnopolimero, colonna in alluminio anodizzato Ø 80mm, crociera.

Top max dimensions / Massima dimensione piano

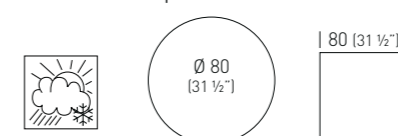

Available table tops / Piani tavolo disponibili

compactop laminated iron

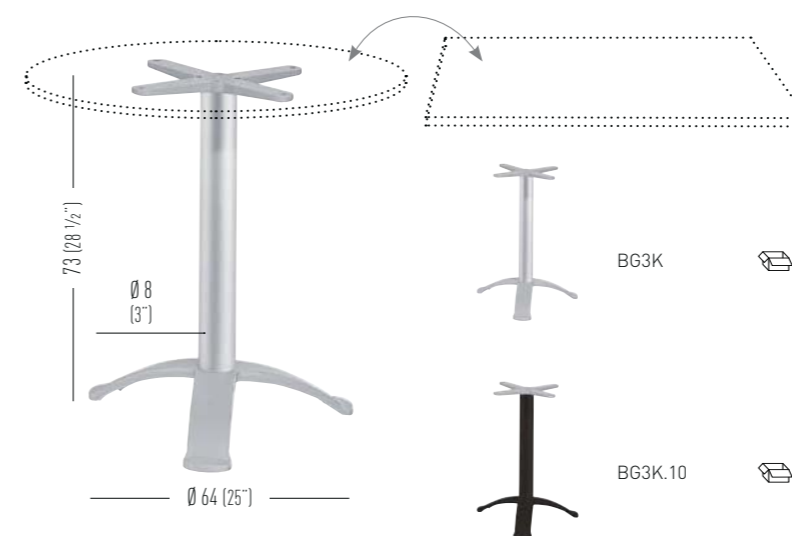

BG3K	0.07m³ / 19.6kg / 2pcs	€ 240,00
------	------------------------	----------

BG3K.10	0.07m³ / 19.6kg / 2pcs	€ 266,00
---------	------------------------	----------

BGA3K

H115 3-spur metal-technopolymer co-injected table base, Ø 80mm anodized aluminum column with cross. Base per tavolo H115 a tre razze in metallo sovrastampato con tecnopolimero, colonna in alluminio anodizzato Ø 80mm, crociera.



Top max dimensions / Massima dimensione piano

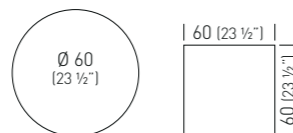

Available table tops / Piani tavolo disponibili

compactop laminated iron

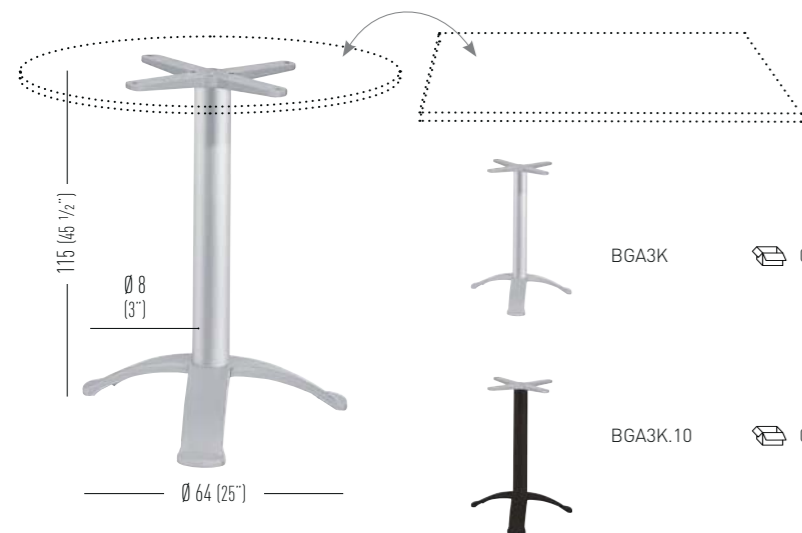

BGA3K 0.12m³ / 21,6kg / 2pcs € **324,00**

BGA3K.10 0.12m³ / 21,6kg / 2pcs € **356,00**

BG3L

H73 3-spur metal-technopolymer co-injected table base, Ø 80mm anodized aluminum column with cross. Base per tavolo H73 a tre razze in metallo sovrastampato con tecnopolimero, colonna in alluminio anodizzato Ø 80mm, crociera.



Top max dimensions / Massima dimensione piano

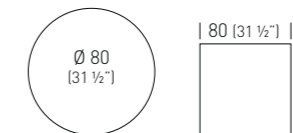

Available table tops / Piani tavolo disponibili

compactop laminated iron

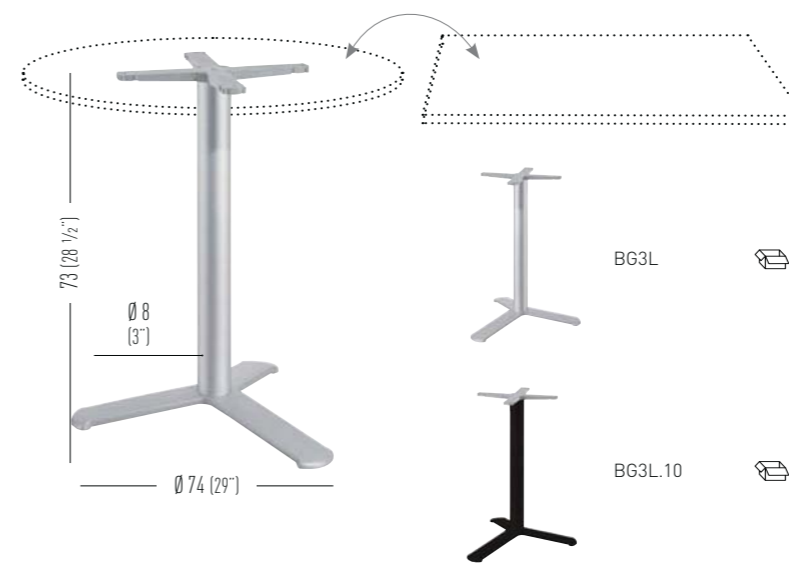

BG3L 0.08m³ / 11kg / 1pcs € **240,00**

BG3L.10 0.08m³ / 11kg / 1pcs € **266,00**

BPG3K

H73 3-spur metal-technopolymer co-injected table base, Ø 60mm anodized aluminum column with cross. Base per tavolo H73 a tre razze in metallo sovrastampato con tecnopolimero, colonna in alluminio anodizzato Ø 60mm, crociera.



Top max dimensions / Massima dimensione piano

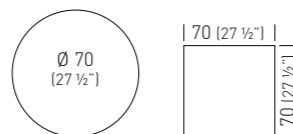

Available table tops / Piani tavolo disponibili

compactop laminated iron

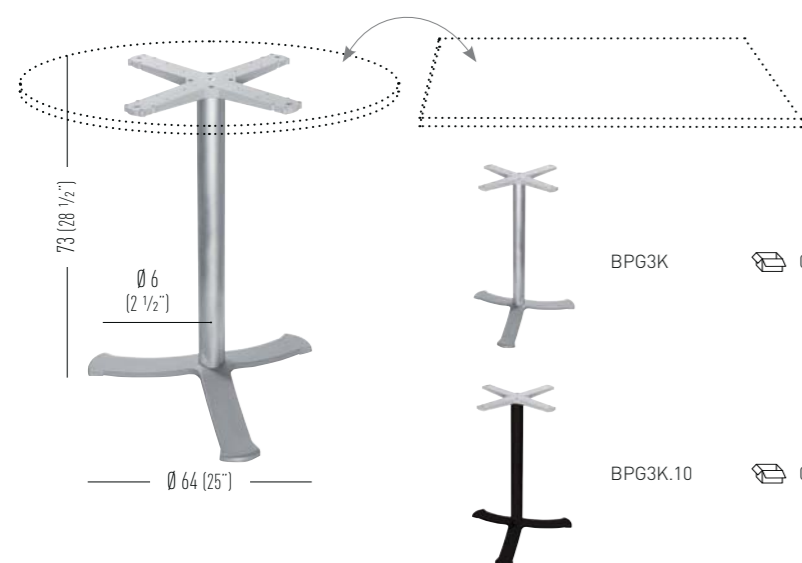

BPG3K 0.07m³ / 14.20kg / 2pcs € **240,00**

BPG3K.10 0.07m³ / 14.20kg / 2pcs € **266,00**

BGA3L

H110 3-spur metal-technopolymer co-injected table base, Ø 80mm anodized aluminum column with cross. Base per tavolo H110 a tre razze in metallo sovrastampato con tecnopolimero, colonna in alluminio anodizzato Ø 80mm, crociera.



Top max dimensions / Massima dimensione piano

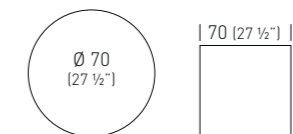

Available table tops / Piani tavolo disponibili

compactop laminated iron



BGA3L 0.12m³ / 23.6kg / 2pcs € **324,00**

BGA3L.10 0.12m³ / 23.6kg / 2pcs € **356,00**

BG4K

H73 4-spur metal-technopolymer co-injected table base, Ø 80mm anodized aluminum column with cross.

Base per tavolo H73 a quattro razze in metallo sovrastampato con tecnopolimero, colonna in alluminio anodizzato Ø 80mm, crociera.



Top max dimensions / Massima dimensione piano

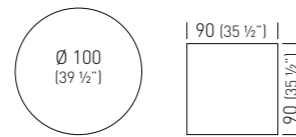

Available table tops / Piani tavolo disponibili

compactop
laminated
iron

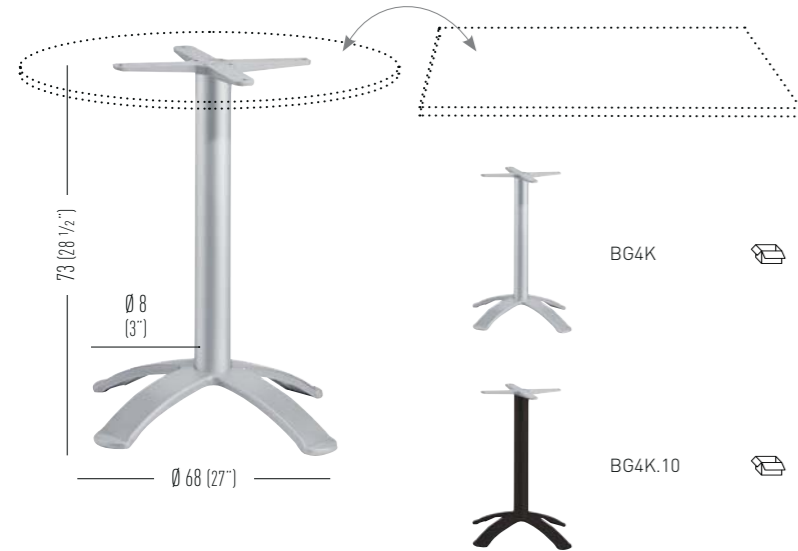

BG4K 0.07m³ / 25kg / 2pcs € **260,00**

BG4K.10 0.07m³ / 25kg / 2pcs € **284,00**

BG4J

H73 4-spur metal-technopolymer co-injected table base, 80x80mm anodized aluminum column with cross.

Base per tavolo H73 a quattro razze in metallo sovrastampato con tecnopolimero, colonna in alluminio anodizzato 80x80mm, crociera.



Top max dimensions / Massima dimensione piano

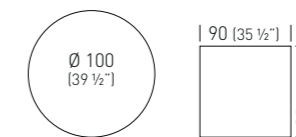

Available table tops / Piani tavolo disponibili

compactop
laminated
iron

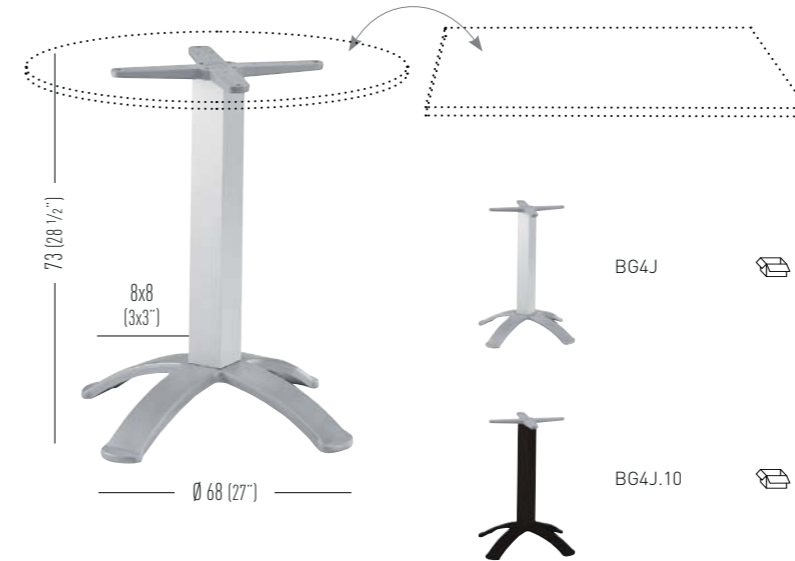

BG4J 0.10m³ / 25.6kg / 2pcs € **272,00**

BG4J.10 0.10m³ / 25.6kg / 2pcs € **300,00**

BGA4K

H115 4-spur metal-technopolymer co-injected table base, Ø 80mm anodized aluminum column with cross.

Base per tavolo H115 a quattro razze in metallo sovrastampato con tecnopolimero, colonna in alluminio anodizzato Ø 80mm, crociera.



Top max dimensions / Massima dimensione piano

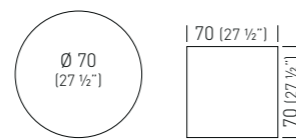

Available table tops / Piani tavolo disponibili

compactop
laminated
iron

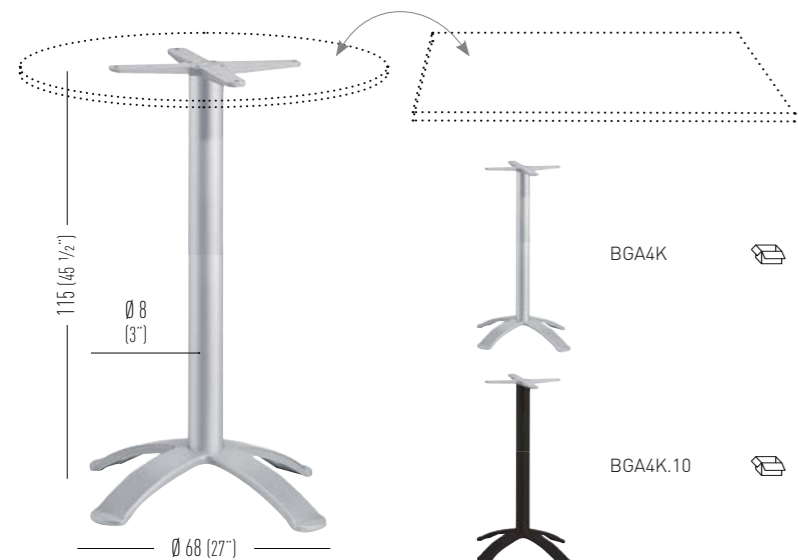

BGA4K 0.11m³ / 26.60kg / 2pcs € **366,00**

BGA4K.10 0.11m³ / 26.60kg / 2pcs € **400,00**

BGPK

H73 4-spur metal-technopolymer co-injected table base, Ø 80mm anodized aluminum column with flip-top mechanism.

Base per tavolo pieghevole H73 a quattro razze in metallo sovrastampato con tecnopolimero, colonna in alluminio anodizzato Ø 80mm.



Top max dimensions / Massima dimensione piano

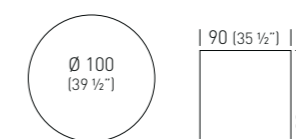

Available table tops / Piani tavolo disponibili

compactop
laminated
iron

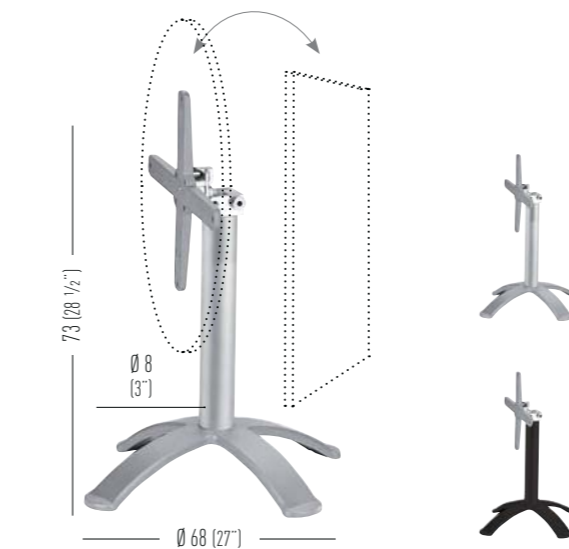

BGPK 0.07m³ / 27kg / 2pcs € **416,00**

BGPK.10 0.07m³ / 27kg / 2pcs € **458,00**

BGPJ

H73 4-spur metal-technopolymer co-injected table base, 80x80mm anodized aluminum column with flip-top mechanism.

Base per tavolo pieghevole H73 a quattro razze in metallo sovrastampato con tecnopolimero, colonna in alluminio anodizzato 80x80mm.

Top max dimensions / Massima dimensione piano

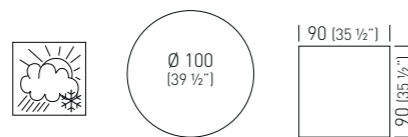

Available table tops / Piani tavolo disponibili

compactop
laminated
iron

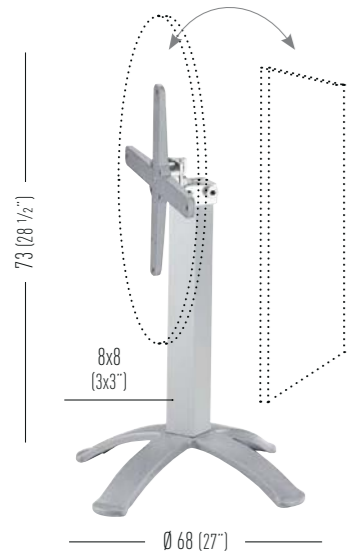

BGPJ 0.10m³ / 27.60kg / 2pcs € **432,00**

BGPJ.10 0.10m³ / 27.60kg / 2pcs € **474,00**

BG4IP

H73 stacking 4-spur metal-technopolymer co-injected table base, Ø 80mm round anodized aluminum column with flip-top mechanism. Adjustable feet.

Base per tavolo pieghevole e accatastabile H73 a quattro razze in metallo sovrastampato con tecnopolimero, colonna in alluminio anodizzato Ø 80mm. Piedini regolabili.

Top max dimensions / Massima dimensione piano

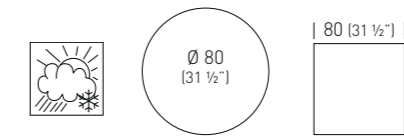

Available table tops / Piani tavolo disponibili

compactop
laminated
iron

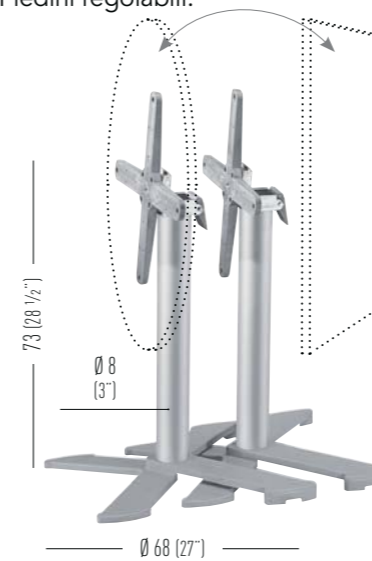

BG4IP 0.07m³ / 20kg / 2pcs € **500,00**

BG4IP.10 0.07m³ / 20kg / 2pcs € **548,00**

BPG4K

H73 4-spur metal-technopolymer co-injected table base, Ø 60mm anodized aluminum column with cross.

Base per tavolo H73 a quattro razze in metallo sovrastampato con tecnopolimero, colonna in alluminio anodizzato Ø 60mm, crociera.

Top max dimensions / Massima dimensione piano

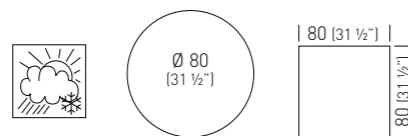

Available table tops / Piani tavolo disponibili

compactop
laminated
iron

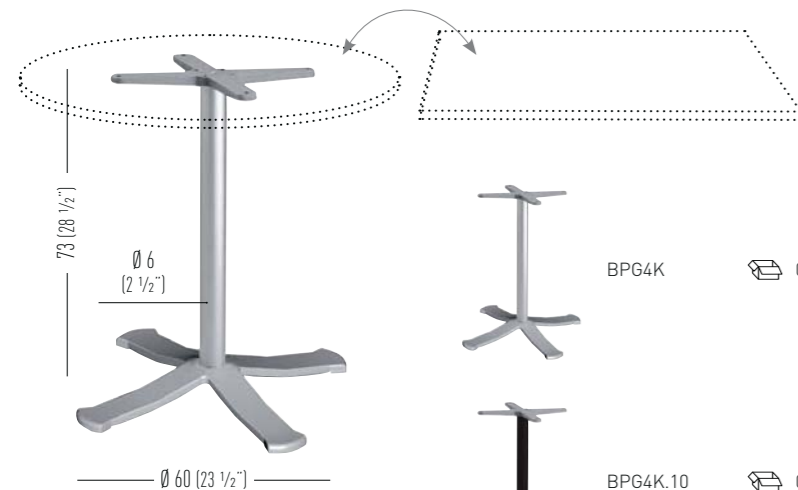

BPG4K 0.07m³ / 17kg / 2pcs € **260,00**

BPG4K.10 0.07m³ / 17kg / 2pcs € **284,00**

BG2J

H73 double metal-technopolymer co-injected table base, 80x80mm anodized aluminum column with cross.

Base doppia per tavolo H73 in metallo sovrastampato con tecnopolimero, colonna in alluminio anodizzato 80x80mm, crociera.

Top max dimensions / Massima dimensione piano

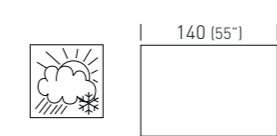

Available table tops / Piani tavolo disponibili

compactop
laminated
iron

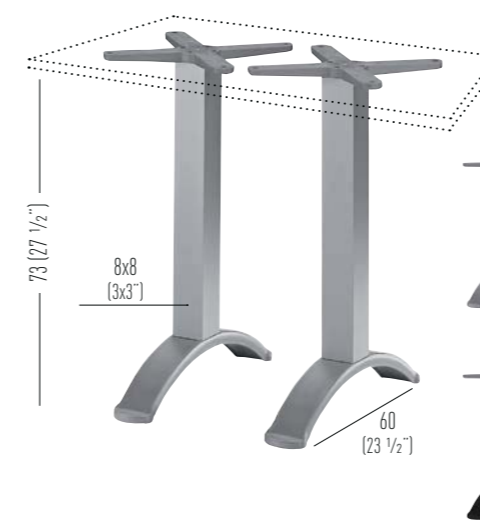

BG2J 0.07m³ / 30kg / 2pcs € **442,00**

BG2J.10 0.07m³ / 30kg / 2pcs € **484,00**

BTK

H73 round metal-technopolymer co-injected table base, Ø 80mm anodized aluminum column with cross.

Base per tavolo H73 rotonda in metallo sovrastampato con tecnopolimero, colonna in alluminio anodizzato Ø 80mm, crociera.

Top max dimensions / Massima dimensione piano

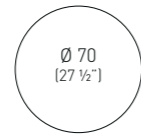

Available table tops / Piani tavolo disponibili

compactop
laminated
iron

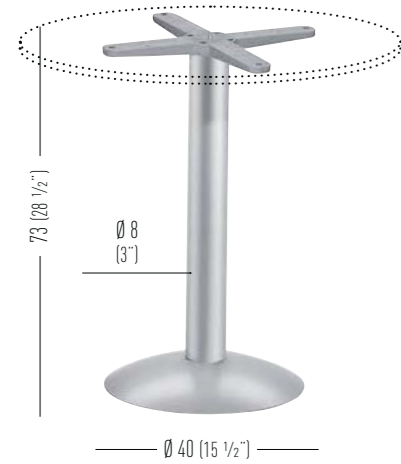

BTK 0.10m³ / 19.60kg / 2pcs € **206,00**

BTK.10 0.10m³ / 19.60kg / 2pcs € **222,00**

BTK54

H73 round metal-technopolymer co-injected table base, Ø 80mm anodized aluminum column with cross.

Base per tavolo H73 rotonda in metallo sovrastampato con tecnopolimero, colonna in alluminio anodizzato Ø 80mm, crociera.

Top max dimensions / Massima dimensione piano

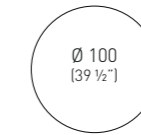

Available table tops / Piani tavolo disponibili

compactop
laminated
iron

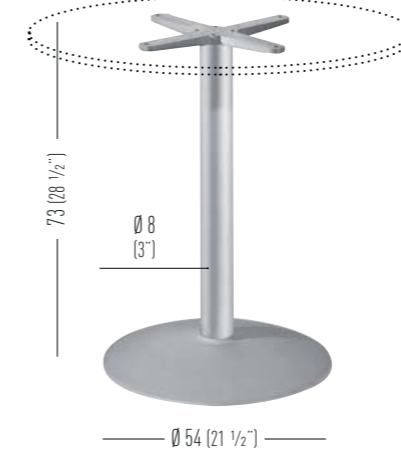

BTK54 0.10m³ / 24.60kg / 2pcs € **238,00**

BTK54.10 0.10m³ / 24.60kg / 2pcs € **262,00**

BTAK

H110 round metal-technopolymer co-injected table base, Ø 80mm anodized aluminum column with cross.

Base per tavolo H110 rotonda in metallo sovrastampato con tecnopolimero, colonna in alluminio anodizzato Ø 80mm, crociera.

Top max dimensions / Massima dimensione piano



Available table tops / Piani tavolo disponibili

compactop
laminated
iron

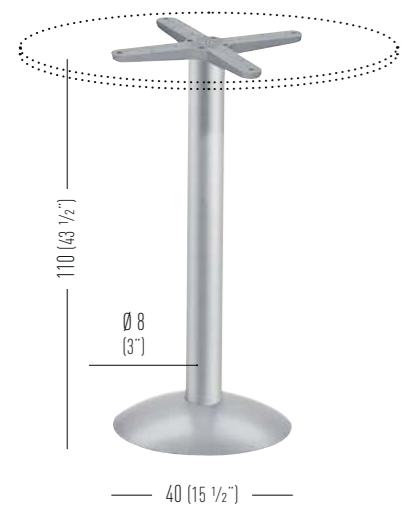

BTAK 0.11m³ / 21.60kg / 2pcs € **266,00**

BTAK.10 0.11m³ / 21.60kg / 2pcs € **292,00**

BTAK54

H110 round metal-technopolymer co-injected table base, Ø 80mm anodized aluminum column with cross.

Base per tavolo H110 rotonda in metallo sovrastampato con tecnopolimero, colonna in alluminio anodizzato Ø 80mm, crociera.

Top max dimensions / Massima dimensione piano



Available table tops / Piani tavolo disponibili

compactop
laminated
iron

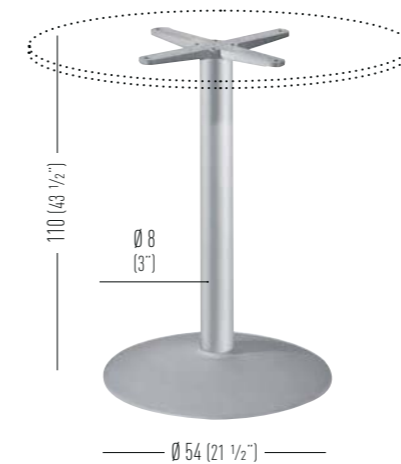

BTAK54 0.11m³ / 25.60kg / 2pcs € **304,00**

BTAK54.10 0.11m³ / 25.60kg / 2pcs € **336,00**

BRCV

H73 round metal-techno-polymer co-injected table base, Ø 50mm metal painted column with cross.
Base per tavolo H73 rotonda in metallo sovrastampato con tecnopolimero, colonna in metallo verniciato Ø 50mm, crociera.

Top max dimensions / Massima dimensione piano

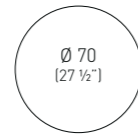

Available table tops / Piani tavolo disponibili

compactop
laminated
iron

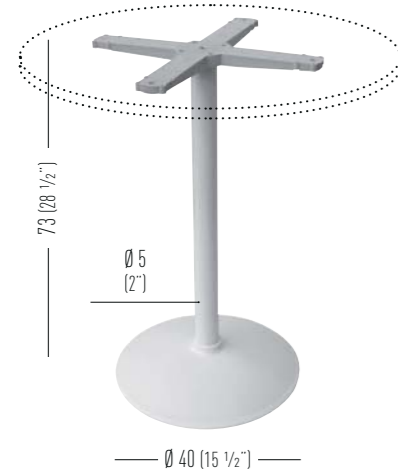

BRCV.00 0.07m³ / 15kg / 2pcs € 234,00

BRCV.10 0.07m³ / 15kg / 2pcs € 234,00

VENUS SQUARE

H73 metal-technopolymer co-injected table base, white color.
Base per tavolo H73 quadrata in metallo sovrastampato con tecnopolimero, colore bianco.

Top max dimensions / Massima dimensione piano

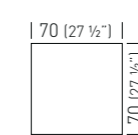

Available table tops / Piani tavolo disponibili

compactop
laminated
iron

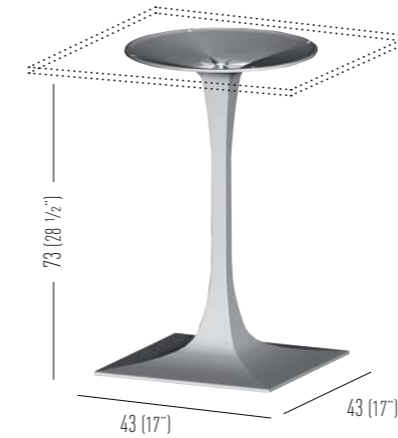

BGVQ.00 0.2m³ / 7kg / 1pcs € 316,00

VENUS ROUND

H73 metal-technopolymer co-injected table base, white color.
Base per tavolo H73 rotonda in metallo sovrastampato con tecnopolimero, colore bianco.

Top max dimensions / Massima dimensione piano

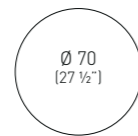

Available table tops / Piani tavolo disponibili

compactop
laminated
iron

Additional weight on request (+3).
Peso supplementare disponibile su richiesta (+3).



BGVR.00 0.2m³ / 6kg / 1pcs € 298,00
BGVR.00+3kg 0.2m³ / 9kg / 1pcs € 360,00

BRK

H73 round metal-technopolymer co-injected table base, Ø 80mm anodized aluminum column with cross.
Base per tavolo H73 rotonda in metallo sovrastampato con tecnopolimero, colonna in alluminio anodizzato Ø 80mm, crociera.

Top max dimensions / Massima dimensione piano

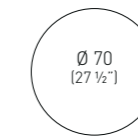

Available table tops / Piani tavolo disponibili

compactop
laminated
iron

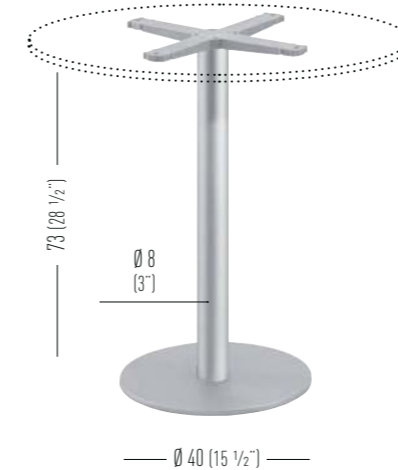

BRK 0.07m³ / 20.60kg / 2pcs € 212,00

BRK.10 0.07m³ / 20.60kg / 2pcs € 232,00

LEI

H73 or H110 4-spur metal-technopolymer co-injected table base, Ø 60mm anodized aluminum column with cross.

Base per tavolo H73 o H110 a quattro razze in metallo sovrastampato con tecnopolimero, colonna in alluminio anodizzato Ø 60mm, crociera.

Top max dimensions / Massima dimensione piano

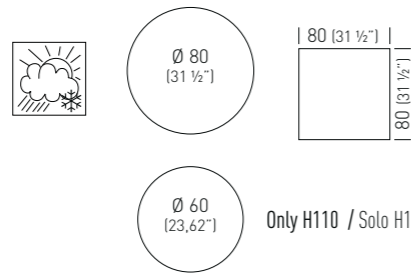

Available table tops / Piani tavolo disponibili

compactop laminated iron

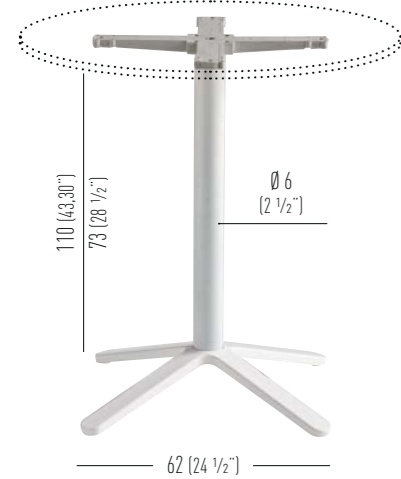

BLEI.00 0.07m³ / 8.5kg / 1pcs € 248,00

BLEIA.00 0.09m³ / 9kg / 1pcs € 274,00

BLEI.10 0.07m³ / 8.5kg / 1pcs € 248,00

BLEIA.10 0.09m³ / 9kg / 1pcs € 274,00

BQAJ

H103 square metal-technopolymer co-injected table base, 80x80mm square anodized aluminum column with cross.

Base per tavolo H103 quadrata in metallo sovrastampato con tecnopolimero, colonna quadrata in alluminio anodizzato 80x80mm, crociera.

Top max dimensions / Massima dimensione piano

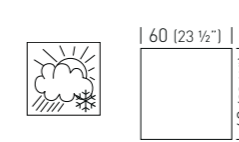

Available table tops / Piani tavolo disponibili

compactop laminated iron



BQAJ 0.08m³ / 25.60kg / 2pcs € 316,00

BQAJR 0.08m³ / 25.60kg / 2pcs € 370,00

Adjustable feet / Piedini regolabili

BQAJ.10 0.08m³ / 25.60kg / 2pcs € 346,00

BQAJR.10 0.08m³ / 25.60kg / 2pcs € 400,00

Adjustable feet / Piedini regolabili

BQJ

H73 square metal-technopolymer co-injected table base, 80x80mm anodized aluminum column with cross.

Base per tavolo H73 quadrata in metallo sovrastampato con tecnopolimero, colonna in alluminio anodizzato 80x80mm, crociera.

Top max dimensions / Massima dimensione piano

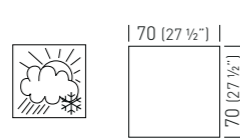

Available table tops / Piani tavolo disponibili

compactop laminated iron

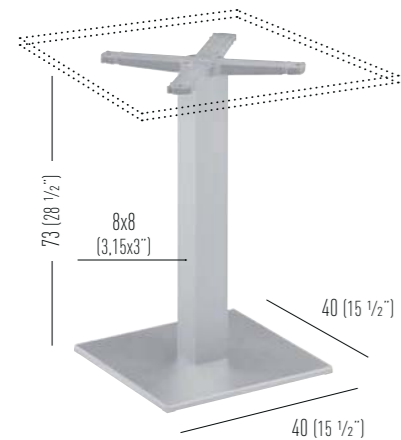

BQJ 0.07m³ / 24.60kg / 2pcs € 234,00

BQJR 0.07m³ / 24.60kg / 2pcs € 268,00

Adjustable feet / Piedini regolabili

BQJ.10 0.07m³ / 24.60kg / 2pcs € 258,00

BQJR.10 0.07m³ / 24.60kg / 2pcs € 310,00

Adjustable feet / Piedini regolabili

AMICA

H73 4-spur table base collection made of die-cast painted aluminum, Ø60mm polymer-steel co-injected column with cross. Adjustable feet.

Collezione basamenti per tavoli H73 a quattro razze in alluminio pressofuso verniciato, colonna in metallo-polimero Ø60mm, con crociera. Piedini regolabili.



BDA1.00

0.07m³ / 6.5kg / 1pcs

€ 260,00



BDA1.10

0.07m³ / 6.5kg / 1pcs

€ 260,00

ADJUSTABLE FEET
PIEDINI REGOLABILI

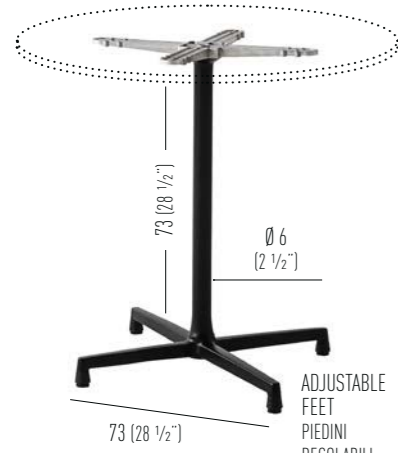

BDA2.00

0.07m³ / 7kg / 1pcs

€ 272,00



BDA2.10

0.07m³ / 7kg / 1pcs

€ 272,00

ADJUSTABLE FEET
PIEDINI REGOLABILI

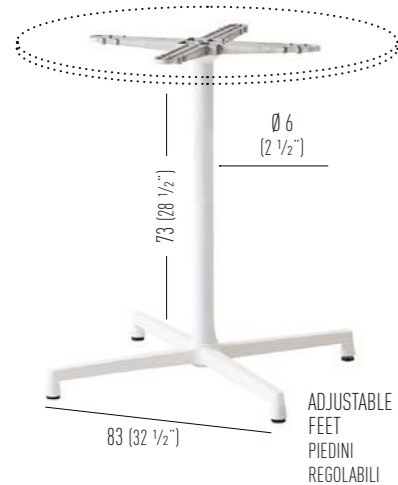

BDA3.00

0.08m³ / 8kg / 1pcs

€ 288,00



BDA3.10

0.08m³ / 8kg / 1pcs

€ 288,00

ADJUSTABLE FEET
PIEDINI REGOLABILI

Available table tops / Piani tavolo disponibili

compactop
laminated
iron

Top max dimensions / Massima dimensione piano

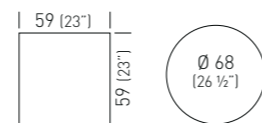

Top max dimensions / Massima dimensione piano

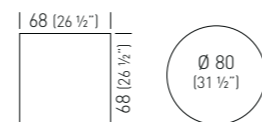

Top max dimensions / Massima dimensione piano

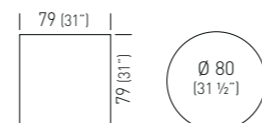

R1

H50-H74-H110 round steel table base, Ø 80mm steel column with cross. Base per tavolo rotonda in acciaio H50, H74 e H110, colonna in acciaio Ø 80mm, crociera.

Top max dimensions / Massima dimensione piano



Available table tops / Piani tavolo disponibili

compactop
laminated
iron

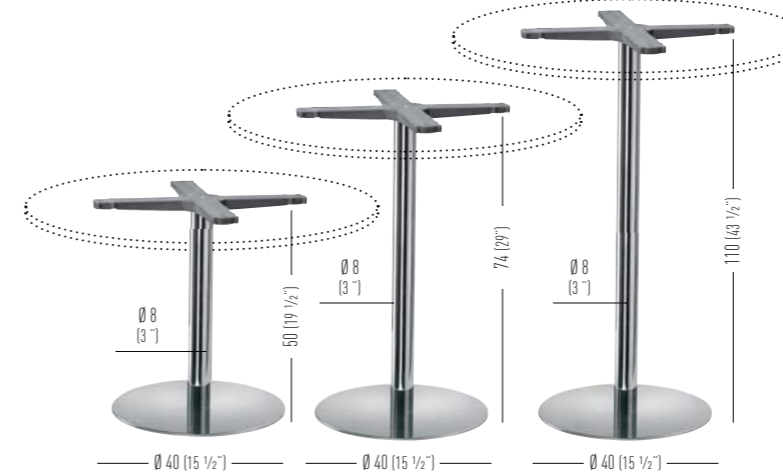

Finishes for R bases / Finiture per basamenti serie R

For orders under 10no. surcharge 20€ each unit
Per ordini inferiori ai 10pz + €20,00 ogni unità.

Polished Steel-Chromed Column / Acciaio Lucido-Colonna Cromata

Polished Steel-Chromed Column / Acciaio Lucido-Colonna Cromata	H50	BAR1B.A	0.07m³ / 15kg / 1pcs	€ 328,00
	H74	BAR1.A	0.07m³ / 15kg / 1pcs	€ 328,00
	H110	BAR1A.A	0.09m³ / 17kg / 1pcs	€ 382,00

Satin Steel-Satin Column / Acciaio Satinato-Colonna Satinata

Satin Steel-Satin Column / Acciaio Satinato-Colonna Satinata	H50	BAR1B.S	0.07m³ / 15kg / 1pcs	€ 342,00
	H74	BAR1.S	0.07m³ / 15kg / 1pcs	€ 342,00
	H110	BAR1A.S	0.09m³ / 17kg / 1pcs	€ 396,00

White Painted / Verniciata Bianca

White Painted / Verniciata Bianca	H50	BAR1B.00	0.07m³ / 15kg / 1pcs	€ 272,00
	H74	BAR1.00	0.07m³ / 15kg / 1pcs	€ 272,00
	H110	BAR1A.00	0.09m³ / 17kg / 1pcs	€ 330,00

Black Painted / Verniciata Nera

Black Painted / Verniciata Nera	H50	BAR1B.10	0.07m³ / 15kg / 1pcs	€ 272,00
	H74	BAR1.10	0.07m³ / 15kg / 1pcs	€ 272,00
	H110	BAR1A.10	0.09m³ / 17kg / 1pcs	€ 330,00

R2

H50-H74-H110 round steel table base, Ø 80mm steel column with cross. Base per tavolo rotonda in acciaio H50, H74 e H110, colonna in acciaio Ø 80mm, crociera.

Top max dimensions / Massima dimensione piano

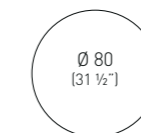

Available table tops / Piani tavolo disponibili

compactop
laminated
iron

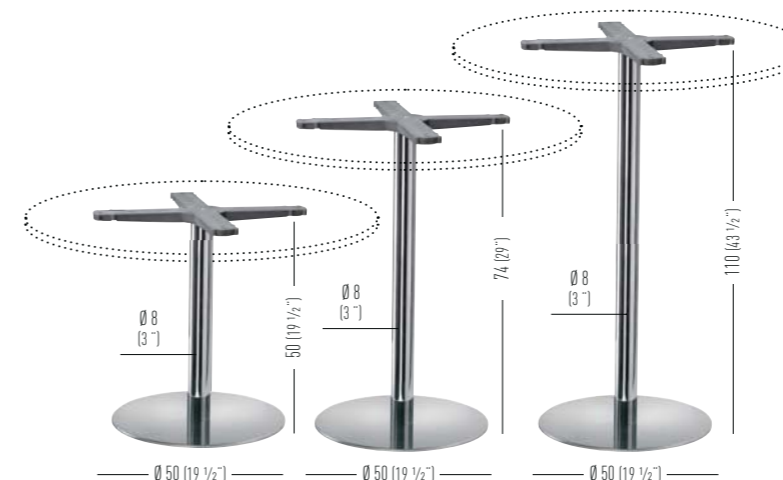

Finishes for R bases / Finiture per basamenti serie R

For orders under 10no. surcharge 20€ each unit
Per ordini inferiori ai 10pz + €20,00 ogni unità.

Polished Steel-Chromed Column / Acciaio Lucido-Colonna Cromata

Polished Steel-Chromed Column / Acciaio Lucido-Colonna Cromata	H50	BAR2B.A	0.07m³ / 18kg / 1pcs	€ 366,00
	H74	BAR2.A	0.07m³ / 18kg / 1pcs	€ 366,00
	H110	BAR2A.A	0.09m³ / 20kg / 1pcs	€ 420,00

Satin Steel-Satin Column / Acciaio Satinato-Colonna Satinata

Satin Steel-Satin Column / Acciaio Satinato-Colonna Satinata	H50	BAR2B.S	0.07m³ / 18kg / 1pcs	€ 434,00
	H74	BAR2.S	0.07m³ / 18kg / 1pcs	€ 434,00
	H110	BAR2A.S	0.09m³ / 20kg / 1pcs	€ 488,00

White Painted / Verniciata Bianca

White Painted / Verniciata Bianca	H50	BAR2B.00	0.07m³ / 18kg / 1pcs	€ 344,00
	H74	BAR2.00	0.07m³ / 18kg / 1pcs	€ 344,00
	H110	BAR2A.00	0.09m³ / 20kg / 1pcs	€ 400,00

Black Painted / Verniciata Nera

Black Painted / Verniciata Nera	H50	BAR2B.10	0.07m³ / 18kg / 1pcs	€ 344,00
	H74	BAR2.10	0.07m³ / 18kg / 1pcs	€ 344,00
	H110	BAR2A.10	0.09m³ / 20kg / 1pcs	€ 400,00

R3

H74-H110 round steel table base,
 Ø 80mm round steel column with cross.
 Base per tavolo rotonda in acciaio H74 e
 H110, colonna rotonda in acciaio
 Ø 80mm, crociera.

Top max dimensions / Massima dimensione piano

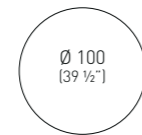

Available table tops / Piani tavolo disponibili

compactop
 laminated
 iron

Finishes for R bases / Finiture per basamenti serie R
 For orders under 10no. surcharge 20€ each unit
 Per ordini inferiori ai 10pz + €20,00 ogni unità.

Polished Steel-Chromed Column / Acciaio Lucido-Colonna Cromata

	H74	BAR3.A	0.07m³ / 21kg / 1pcs	€ 432,00
	H110	BAR3A.A	0.09m³ / 23kg / 1pcs	€ 576,00

Satin Steel-Satin Column / Acciaio Satinato-Colonna Satinata

	H74	BAR3.S	0.07m³ / 21kg / 1pcs	€ 432,00
	H110	BAR3A.S	0.09m³ / 23kg / 1pcs	€ 576,00

White Painted / Verniciata Bianca

	H74	BAR3.00	0.07m³ / 21kg / 1pcs	€ 392,00
	H110	BAR3A.00	0.09m³ / 23kg / 1pcs	€ 448,00

Black Painted / Verniciata Nera

	H74	BAR3.10	0.07m³ / 21kg / 1pcs	€ 392,00
	H110	BAR3A.10	0.09m³ / 23kg / 1pcs	€ 448,00



T1 FLOOR FIXING

Floor Fixing H74 round steel table base,
 Ø 80mm round steel column with cross.
 Base per tavolo H74 rotonda in metallo
 per fissaggio a terra, colonna rotonda in
 metallo Ø 80mm, crociera.

Top max dimensions / Massima dimensione piano

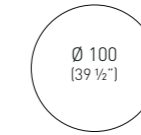

Available table tops / Piani tavolo disponibili

compactop
 laminated
 iron

Finishes for T1 bases / Finiture per basamenti serie T1
 For orders under 10no. surcharge 20€ each unit
 Per ordini inferiori ai 10pz + €20,00 ogni unità.

Polished Steel-Chromed Column / Acciaio Lucido-Colonna Cromata

	H74	BAT1.S	0.07m³ / 11kg / 1pcs	€ 256,00
--	-----	--------	----------------------	----------

Min. order 5pcs
 each code
 Ordine min 5pz
 per codice



V1

H73 roundchromed metal table base,
 Ø 50mm chromed metal column with
 cross.
 Base per tavolo H73 rotonda in metallo
 cromato, colonna in metallo cromato
 Ø 50mm, crociera.

Top max dimensions / Massima dimensione piano

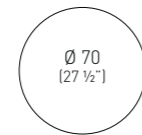

Available table tops / Piani tavolo disponibili

compactop
 laminated
 iron

Finishes for V1 bases / Finiture per basamenti serie V1

Polished Steel-Chromed Column / Acciaio Lucido-Colonna Cromata

	H73	BV1C	0.1m³ / 15.6kg / 2 pcs	€ 266,00
--	-----	------	------------------------	----------

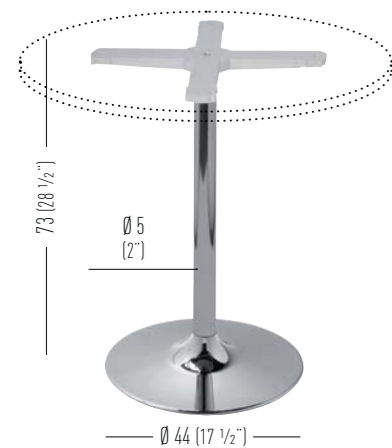

Q1

H50-H74-H110 square steel table base,
 80x80mm steel column with cross.
 Base per tavolo quadrata in acciaio
 H50, H74 e H110, colonna in acciaio
 80x80mm, crociera.

Top max dimensions / Massima dimensione piano

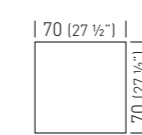

Available table tops / Piani tavolo disponibili

compactop
 laminated
 iron

Finishes for Q bases / Finiture per basamenti serie Q
 For orders under 10no. surcharge 20€ each unit
 Per ordini inferiori ai 10pz + €20,00 ogni unità.

Polished Steel-Chromed Column / Acciaio Lucido-Colonna Cromata

	H50	BAQ1B.A	0.07m³ / 17kg / 1pcs	€ 342,00
	H74	BAQ1.A	0.07m³ / 17kg / 1pcs	€ 342,00
	H110	BAQ1A.A	0.09m³ / 19kg / 1pcs	€ 396,00

Satin Steel-Satin Column / Acciaio Satinato-Colonna Satinata

	H50	BAQ1B.S	0.07m³ / 17kg / 1pcs	€ 372,00
	H74	BAQ1.S	0.07m³ / 17kg / 1pcs	€ 372,00
	H110	BAQ1A.S	0.09m³ / 19kg / 1pcs	€ 430,00

White Painted / Verniciata Bianca

	H50	BAQ1B.00	0.07m³ / 17kg / 1pcs	€ 282,00
	H74	BAQ1.00	0.07m³ / 17kg / 1pcs	€ 282,00
	H110	BAQ1A.00	0.09m³ / 19kg / 1pcs	€ 336,00

Black Painted / Verniciata Nera

	H50	BAQ1B.10	0.07m³ / 17kg / 1pcs	€ 282,00
	H74	BAQ1.10	0.07m³ / 17kg / 1pcs	€ 282,00
	H110	BAQ1A.10	0.09m³ / 19kg / 1pcs	€ 336,00

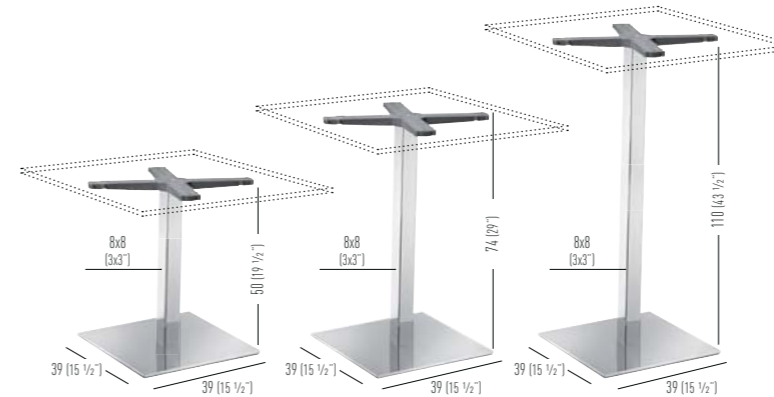

Q2

H50-H74-H110 square steel table base, 80x80mm steel column with cross.
Base per tavolo quadrata in acciaio H50, H74 e H110, colonna in acciaio 80x80mm, crociera.

Top max dimensions / Massima dimensione piano

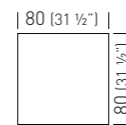

Available table tops / Piani tavolo disponibili

compactop
laminated
iron

Finishes for Q bases / Finiture per basamenti serie Q

For orders under 10no. surcharge 20€ each unit
Per ordini inferiori ai 10pz + €20,00 ogni unità.

Polished Steel-Chromed Column / Acciaio Lucido-Colonna Cromata

	H50	BAQ2B.A		0.07m ³ / 18kg / 1pcs	€ 444,00
	H74	BAQ2.A		0.07m ³ / 18kg / 1pcs	€ 444,00
	H110	BAQ2A.A		0.09m ³ / 20kg / 1pcs	€ 502,00

Satin Steel-Satin Column / Acciaio Satinato-Colonna Satinata

	H50	BAQ2B.S		0.07m ³ / 18kg / 1pcs	€ 454,00
	H74	BAQ2.S		0.07m ³ / 18kg / 1pcs	€ 454,00
	H110	BAQ2A.S		0.09m ³ / 20kg / 1pcs	€ 508,00

White Painted / Verniciata Bianca

	H50	BAQ2B.00		0.07m ³ / 18kg / 1pcs	€ 356,00
	H74	BAQ2.00		0.07m ³ / 18kg / 1pcs	€ 356,00
	H110	BAQ2A.00		0.09m ³ / 20kg / 1pcs	€ 414,00

Black Painted / Verniciata Nera

	H50	BAQ2B.10		0.07m ³ / 18kg / 1pcs	€ 356,00
	H74	BAQ2.10		0.07m ³ / 18kg / 1pcs	€ 356,00
	H110	BAQ2A.10		0.09m ³ / 20kg / 1pcs	€ 414,00

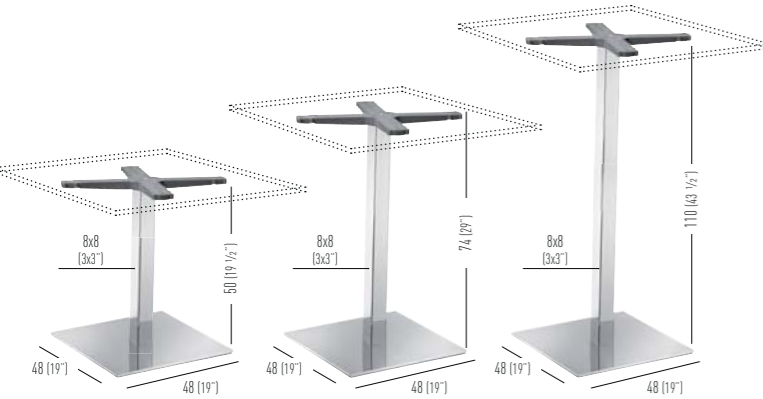

Q3

H74-H110 square steel table base, 80x80mm steel column with cross.
Base per tavolo quadrata in acciaio H74 e H110, colonna in acciaio 80x80mm, crociera.

Top max dimensions / Massima dimensione piano

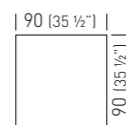

Available table tops / Piani tavolo disponibili

compactop
laminated
iron

Finishes for Q bases / Finiture per basamenti serie Q

For orders under 10no. surcharge 20€ each unit
Per ordini inferiori ai 10pz + €20,00 ogni unità.

Polished Steel-Chromed Column / Acciaio Lucido-Colonna Cromata

	H74	BAQ3.A		0.07m ³ / 23kg / 1pcs	€ 548,00
	H110	BAQ3A.A		0.09m ³ / 25kg / 1pcs	€ 602,00

Satin Steel-Satin Column / Acciaio Satinato-Colonna Satinata

	H74	BAQ3.S		0.07m ³ / 23kg / 1pcs	€ 552,00
	H110	BAQ3A.S		0.09m ³ / 25kg / 1pcs	€ 608,00

White Painted / Verniciata Bianca

	H74	BAQ3.00		0.07m ³ / 23kg / 1pcs	€ 410,00
	H110	BAQ3A.00		0.09m ³ / 25kg / 1pcs	€ 466,00

Black Painted / Verniciata Nera

	H74	BAQ3.10		0.07m ³ / 23kg / 1pcs	€ 410,00
	H110	BAQ3A.10		0.09m ³ / 25kg / 1pcs	€ 466,00

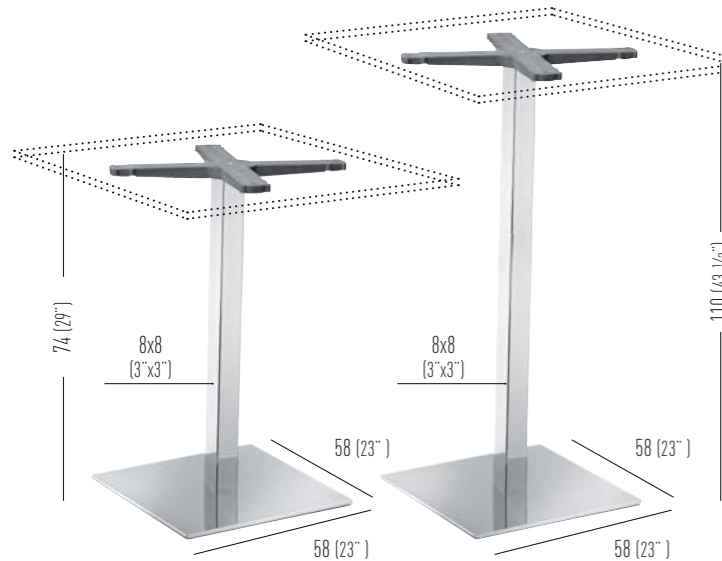

D2

H74-H110 double steel table base, 80x80mm steel columns with cross.
Base doppia per tavolo H74 e H110 in acciaio, colonne in acciaio 80x80mm, crociera.

Top max dimensions / Massima dimensione piano

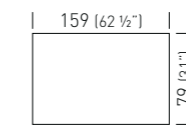

Available table tops / Piani tavolo disponibili

compactop
laminated
iron

Finishes for D2 bases / Finiture per basamenti serie D2

Polished Steel-Chromed Column / Acciaio Lucido-Colonna Cromata

	H74	BAD2.A		0.22m ³ / 32kg / 1pcs	€ 558,00
--	-----	--------	--	----------------------------------	----------

Satin Steel-Satin Column / Acciaio Satinato-Colonna Satinata

	H74	BAD2.S		0.22m ³ / 32kg / 1pcs	€ 610,00
--	-----	--------	--	----------------------------------	----------

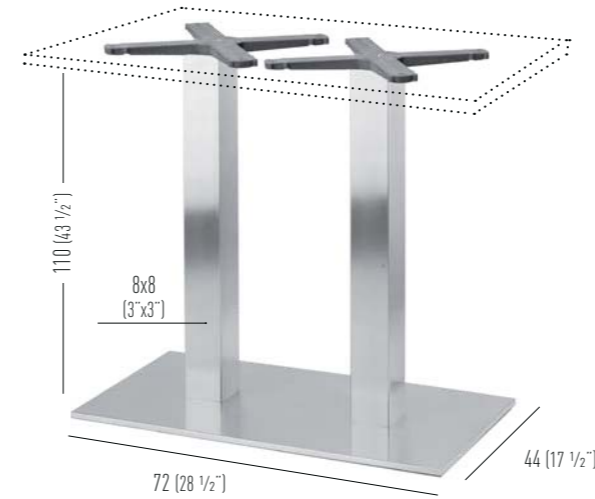
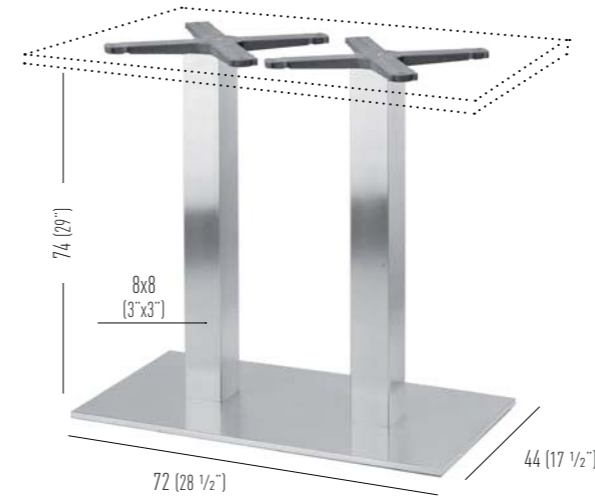

Polished Steel-Chromed Column / Acciaio Lucido-Colonna Cromata

	H110	BAD2A.A		0.22m ³ / 35kg / 1pcs	€ 636,00
--	------	---------	--	----------------------------------	----------

Satin Steel-Satin Column / Acciaio Satinato-Colonna Satinata

	H110	BAD2A.S		0.22m ³ / 35kg / 1pcs	€ 686,00
--	------	---------	--	----------------------------------	----------

ALFIE

H72 4-Spur table base collection made of painted steel, Ø100mm metal painted column with cross. Adjustable feet. Collezione basamenti per tavoli, H72, quattro razze in acciaio verniciato, colonna in metallo verniciato Ø100mm con crociera. Piedini regolabili.



Available top sizes / Dimensioni piano disponibili

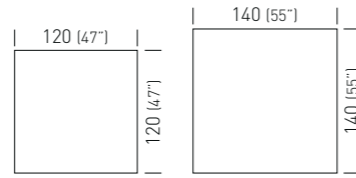
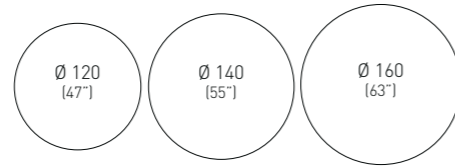

Black Painted / Verniciata Nera



BALF.10

0.13m³ / 15kg / 1pcs

Available table tops / Piani tavolo disponibili

laminated

€ 694,00

TATAMI

H74-H110 round steel table base, Ø 80mm steel similar wood-effect column with cross.

Base per tavolo rotonda in acciaio H74 e H110, colonna finto legno Ø 80mm, crociera.

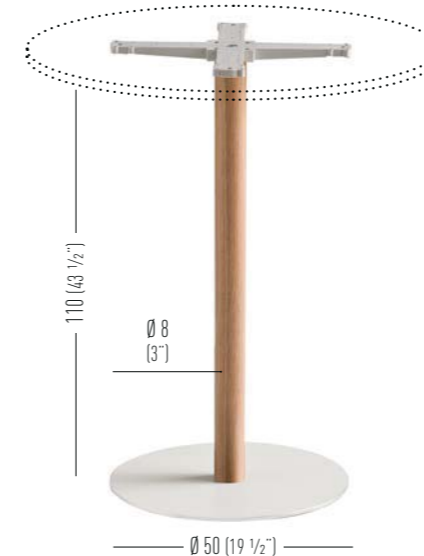
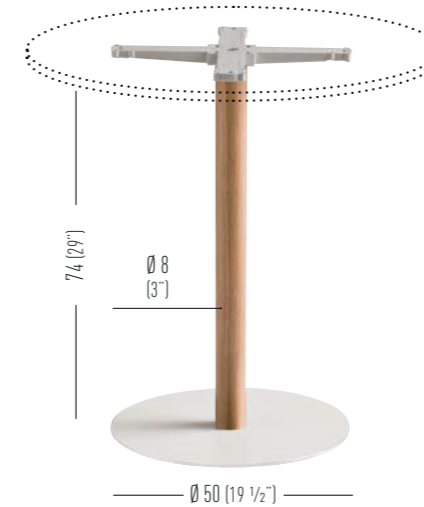

Top max dimensions / Massima dimensione piano



Available table tops / Piani tavolo disponibili

compact
laminated
iron

Finishes for TATAMI bases / Finiture per basamenti serie Tatami

For orders under 10no. surcharge 20€ each unit
Per ordini inferiori ai 10pz + €20,00 ogni unità.

Polished Steel / Acciaio Lucido



BARTA._

0.07m³ / 18kg / 1pcs

€ 424,00

Satin Steel / Acciaio Satinato



BART.S._

0.07m³ / 18kg / 1pcs

€ 456,00

White Painted / Verniciata Bianca



BART.00._

0.07m³ / 18kg / 1pcs

€ 364,00

Black Painted / Verniciata Nera



BART.10._

0.07m³ / 18kg / 1pcs

€ 364,00

Finishes for Tatami columns / Finiture per colonne serie Tatami



F

Natural Beech effect
Faggio Naturale finto legno



RN

Oak effect
Rovere finto legno

Finishes for TATAMI bases / Finiture per basamenti serie Tatami

For orders under 10no. surcharge 20€ each unit
Per ordini inferiori ai 10pz + €20,00 ogni unità.

Polished Steel / Acciaio Lucido



BARTA.A._

0.09m³ / 20kg / 1pcs

€ 484,00

Satin Steel / Acciaio Satinato



BARTA.S._

0.09m³ / 20kg / 1pcs

€ 518,00

White Painted / Verniciata Bianca



BARTA.00._

0.09m³ / 20kg / 1pcs

€ 424,00

Black Painted / Verniciata Nera



BARTA.10._

0.09m³ / 20kg / 1pcs

€ 424,00

Finishes for Tatami columns / Finiture per colonne serie Tatami



F

Natural Beech effect
Faggio Naturale finto legno



RN

Oak effect
Rovere finto legno

L0L3 BASE

H49-H74 3-spur table base collection, made of steel treated for outdoor use, matt finish.

Basamento per tavolo H49-H74 a tre razze, realizzato in acciaio trattato per esterni, finitura opaca.



Only for the base
Solo per il basamento

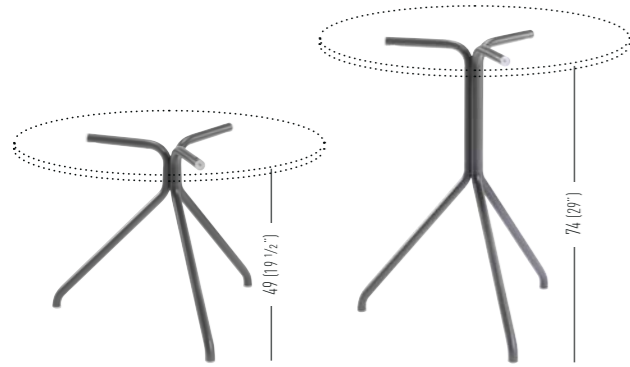

Top max dimensions / Massima dimensione piano



Available table tops / Piani tavolo disponibili

laminated

Frame Color / Colore Struttura

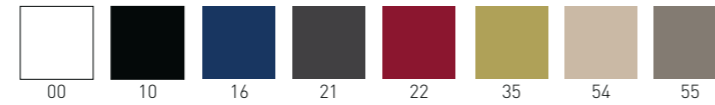

H49	BLOL3._/H49	0.17m³ / 3.5kg / 1pc	€ 172,00
H74	BLOL3._/H74	0.24m³ / 4.1kg / 1pc	€ 178,00

Min. order 10pcs
each code
Ordine min 10pz
per codice

L0L4 BASE

H74 4-spur table base collection, made of steel treated for outdoor use, matt finish. Basamento per tavolo H74 a quattro razze, realizzato in acciaio trattato per esterni, finitura opaca.



Only for the base
Solo per il basamento

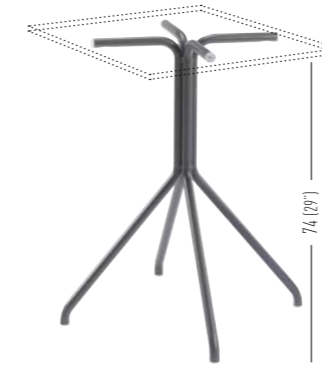

Top max dimensions / Massima dimensione piano

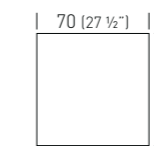

Available table tops / Piani tavolo disponibili

compactop
laminated

Frame Color / Colore Struttura

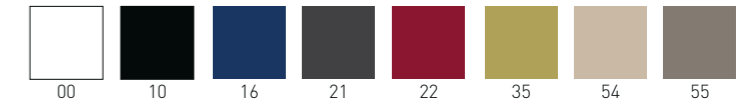

H74	BLOL4._/H74	0.24m³ / 4.9kg / 1pc	€ 192,00
-----	-------------	----------------------	-----------------

Min. order 10pcs
each code
Ordine min 10pz
per codice

Top max dimensions / Massima dimensione piano

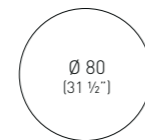

Available table tops / Piani tavolo disponibili

laminated

Frame Color / Colore Struttura

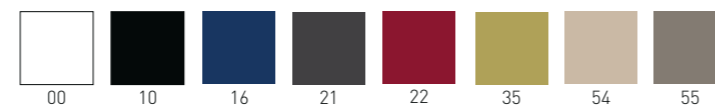

H74L	BLOL3L._/H74	0.43m³ / 4.2Kg / 1pc	€ 190,00
------	--------------	----------------------	-----------------

Min. order 10pcs
each code
Ordine min 10pz
per codice



Only for the base
Solo per il basamento



Top max dimensions / Massima dimensione piano

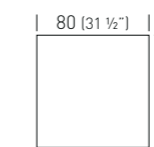

Available table tops / Piani tavolo disponibili

compactop
laminated

Frame Color / Colore Struttura

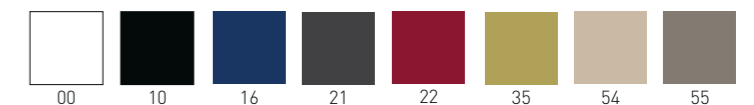

H74L	BLOL4L._/H74	0.35m³ / 5.2kg / 1pc	€ 202,00
------	--------------	----------------------	-----------------

Min. order 10pcs
each code
Ordine min 10pz
per codice

LOL PLUS BASE

The Lol Plus table bases collection is made of steel, the cross is made in die cast aluminum, and provided with flip-top joint. The shape of the base and the flip-top mechanism allow the table to easily fold and stack, space-saving. The available colour palette is common to many Gaber seating collections, guaranteeing tone-on-tone colour co-ordination throughout designed settings rather than lively contrasts, defining various colour combinations between bases, tops and seating.

La Collezione di basamenti Lol Plus è realizzata in acciaio, la crociera è realizzata in presso fusione di alluminio, ed è dotata di giunto per la rotazione del piano. La forma della base e la meccanica che permette la rotazione del piano in posizione verticale, rendono il tavolo facilmente accatastabile in spazi ridotti. La palette di colori disponibile è comune a molte collezioni di sedute Gaber, garantendo abbinamenti tono su tono degli ambienti progettati, piuttosto che vivaci contrasti, definendo diverse combinazioni di colori tra basi, piani e sedute.



Only for the base
Solo per il basamento

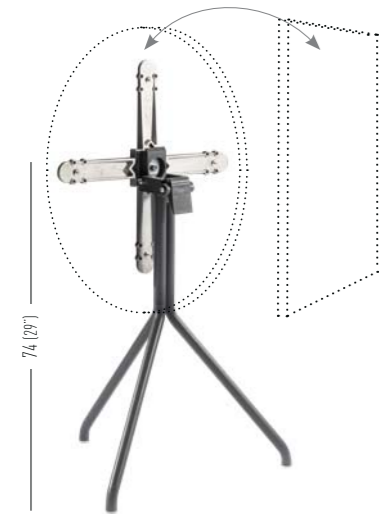

Top max dimensions / Massima dimensione piano

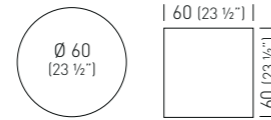

Available table tops / Piani tavolo disponibili

compactop
laminated

Frame Color / Colore Struttura

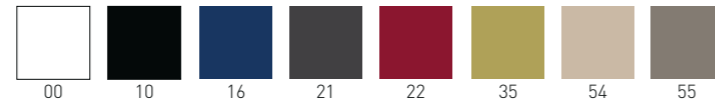

H74 BLOLP_/H74 0.24m3 / 5.3kg / 1pc € **338,00**

Min. order 10pcs
each code
Ordine min 10pz
per codice

BRISTOL BASE

4-spur H74 table base in epoxy powder coated steel treated for outdoor use, and equipped with adjustable feet.

Basamento per tavolo H74 con struttura a quattro razze, dotato di piedini regolabili, in acciaio verniciato a polveri epossidiche con trattamento per esterno.

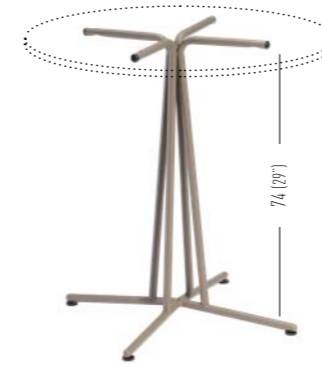

Top max dimensions / Massima dimensione piano

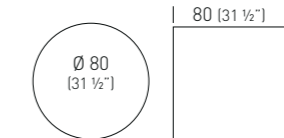

Available table tops / Piani tavolo disponibili

compactop
laminated

Frame Color / Colore Struttura

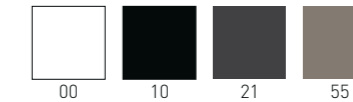

H74 BBRS_/H74 0.23m3 / 5.5kg / 1pc € **254,00**

Minimum order 20 pcs each code, unless combined with Gaber table tops.
Ordine minimo 20 pezzi per codice, se non abbinato a piani Gaber.

GLITTER BASE

H74 and H105 tripod table bases in epoxy powder coated steel with outdoor treatment.

Basamento per tavolo H74-H105 con struttura a tre punti di appoggio, realizzato in acciaio verniciato a polveri epossidiche con trattamento per esterno.



Top max dimensions / Massima dimensione piano

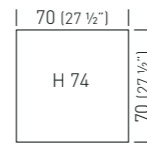

Available table tops / Piani tavolo disponibili

compactop
laminated



Frame Color / Colore Struttura

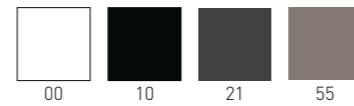

H74	BGLT._/H74	0.18m3 / 2.9kg / 1pc	€ 218,00
H105	BGLT._/H105	0.18m3 / 3.55kg / 1pc	€ 272,00

Minimum order 20 pcs each code, unless combined with Gaber table tops.
Ordine minimo 20 pezzi per codice, se non abbinato a piani Gaber.

OFFICE & WORKSPACES System



Workstation 2027

This office furniture collection is intended for modern workplaces. It is distinguished by simple and rational worktop lines as well as slender and resistant support frames with a trestle shape. The service cabinets are suspended, a feature designed for easy and modern cleaning. The desks can be equipped with high-performance sound-absorbing screens, to improve privacy and the general acoustics of the workplace. The assembly systems have been especially designed to be fast and safe.

Programma d'arredo destinato ad uffici moderni con piani di lavoro dalle linee semplici e razionali, strutture di sostegno con forma a cavalletto per essere snelle e resistenti. I mobili di servizio sono sospesi, caratteristica pensata per una semplice e moderna pulizia automatica. Le scrivanie possono essere dotate di schermi divisorii per migliorare la privacy e l'acustica. I sistemi di assemblaggio sono veloci e sicuri.

Finishings / Finiture

Melamine Laquered Cabinets Colors
(Antibacterial water-base laquering)
Colori Laccati Mobili Melaminico
(Laccatura antibatterica a base acqua)



Frame colors
Colori struttura



Melamine Cabinets Color
Colori Mobili Melaminico



Laminated top color
ABS Edge
Colori piano laminato
Bordo ABS



White Matte Laquered Neve (00) / Black Matte Laquered (10) / Blue Matte Laquered 5003 (16) / Grey Matte Laquered Antracite (21) / Bordeaux Matte Laquered 3004 (22)
Lime Matte Laquered Limone (35) / Mineral Grey Matte Laquered 7006 (55)

Option: Cod. 1101
Cable Routing Option, anodized Aluminum 8x8 cm, black brush
Opzione Passacavi, Alluminio anodizzato 8x8 cm spazzolina nera
€ 80,00



Option: Cod. ACCV030_...
Metal Fairlead Solution
Tubo metallico passacavi
€ 96,00



WORKSTATION 2027 DX VERSION 180



Workstation with 2027 structure, cabinet consisting of module with sliding doors and lock, 1 partition and 1 shelf per compartment, open module with 1 shelf. Straight desktop white colour, thickness 22mm.

Stazione di lavoro con struttura 2027, mobile composto da modulo con ante scorrevoli e serratura, 1 tramezza e 1 ripiano per vano, modulo a giorno con 1 ripiano. Piano scrivania di lavoro dritta di colore bianco, spessore 22mm.

Melamine Laquered Cabinets Colors
Colori Laccati Mobili Melaminico



Frame colors
Colori struttura



Melamine Cabinets Color
Colori Mobili Melaminico



Laminated top color
Colori piano laminato

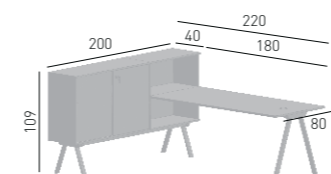

Unassembled structure, individual modules assembled.
Struttura non assemblata, singoli moduli assemblati.



1,07 m³
114,5 kg.

Finishing & Codes / Finiture e Codici

Melamine Cabinets / Mobili in Melaminico

cod. **WRKMD1D.00-00/PK_**

Melamine Laquered Cabinets / Mobili in Melaminico Laccato

cod. **WRKQD1D._-00/PK_**

€ **2.976,00**

€ **4.162,00**

WORKSTATION 2027 SX VERSION 180



Workstation with 2027 structure, cabinet consisting of module with sliding doors and lock, 1 partition and 1 shelf per compartment, open module with 1 shelf. Straight desktop white colour, thickness 22mm.

Stazione di lavoro con struttura 2027, mobile composto da modulo con ante scorrevoli e serratura, 1 tramezza e 1 ripiano per vano, modulo a giorno con 1 ripiano. Piano scrivania di lavoro dritta di colore bianco, spessore 22mm.

Melamine Laquered Cabinets Colors
Colori Laccati Mobili Melaminico



Frame colors
Colori struttura



Melamine Cabinets Color
Colori Mobili Melaminico



Laminated top color
Colori piano laminato

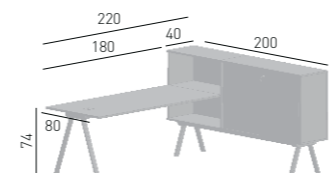

Unassembled structure, individual modules assembled.
Struttura non assemblata, singoli moduli assemblati.



1,07 m³
114,5 kg.

Finishing & Codes / Finiture e Codici

Melamine Cabinets / Mobili in Melaminico

cod. **WRKMD1S.00-00/PK_**

Melamine Laquered Cabinets / Mobili in Melaminico Laccato

cod. **WRKQD1S._-00/PK_**

€ **2.976,00**

€ **4.162,00**

WORKSTATION 2027 DX VERSION 240



Workstation with 2027 structure, cabinet consisting of module with sliding doors and lock, 1 partition and 1 shelf per compartment, open module with 1 shelf. Straight desktop white colour, thickness 22mm.
Stazione di lavoro con struttura 2027, mobile composto da modulo con ante scorrevoli e serratura, 1 tramezza e 1 ripiano per vano, modulo a giorno con 1 ripiano. Piano scrivania di lavoro diritta di colore bianco, spessore 22mm.

Melamine Laquered Cabinets Colors
Colori Laccati Mobili Melaminico



Frame colors
Colori struttura



Melamine Cabinets Color
Colore Mobili Melaminico



Laminated top color
Colori piano laminato

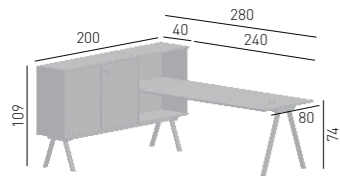

Unassembled structure, individual modules assembled.
Struttura non assemblata, singoli moduli assemblati.

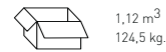

1,12 m³
124,5 kg.

Finishing & Codes / Finiture e Codici

Melamine Cabinets / Mobili in Melaminico

cod. **WRKMD2D.00-00/PK__**

Melamine Laquered Cabinets / Mobili in Melaminico Laccato

cod. **WRKQD2D.__-00/PK__**

€ **3.304,00**

€ **4.474,00**

WORKSTATION 2027 DX L-VERSION 180



Workstation with 2027 structure, cabinet consisting of module with sliding doors and lock, 1 partition and 1 shelf per compartment, open module with 1 shelf. Wraparound work desktop white colour, thickness 22mm.
Stazione di lavoro con struttura 2027, mobile composto da modulo con ante scorrevoli e serratura, 1 tramezza e 1 ripiano per vano, modulo a giorno con 1 ripiano. Piano scrivania di lavoro avvolgente di colore bianco, spessore 22mm.

Melamine Laquered Cabinets Colors
Colori Laccati Mobili Melaminico



Frame colors
Colori struttura



Melamine Cabinets Color
Colore Mobili Melaminico



Laminated top color
Colori piano laminato

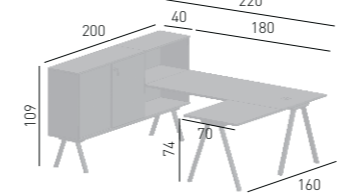

Unassembled structure, individual modules assembled.
Struttura non assemblata, singoli moduli assemblati.



1,12 m³
129,5 kg.

Finishing & Codes / Finiture e Codici

Melamine Cabinets / Mobili in Melaminico

cod. **WRKML1D.00-00/PK__**

Melamine Laquered Cabinets / Mobili in Melaminico Laccato

cod. **WRKQL1D.__-00/PK__**

€ **3.534,00**

€ **4.628,00**

WORKSTATION 2027 SX VERSION 240



Workstation with 2027 structure, cabinet consisting of module with sliding doors and lock, 1 partition and 1 shelf per compartment, open module with 1 shelf. Straight desktop white colour, thickness 22mm.
Stazione di lavoro con struttura 2027, mobile composto da modulo con ante scorrevoli e serratura, 1 tramezza e 1 ripiano per vano, modulo a giorno con 1 ripiano. Piano scrivania di lavoro diritta di colore bianco, spessore 22mm.

Melamine Laquered Cabinets Colors
Colori Laccati Mobili Melaminico



Frame colors
Colori struttura



Melamine Cabinets Color
Colore Mobili Melaminico



Laminated top color
Colori piano laminato

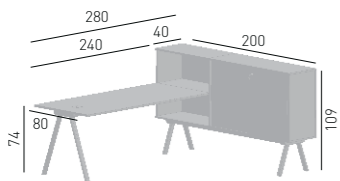

Unassembled structure, individual modules assembled.
Struttura non assemblata, singoli moduli assemblati.

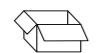

1,12 m³
124,5 kg.

Finishing & Codes / Finiture e Codici

Melamine Cabinets / Mobili in Melaminico

cod. **WRKMD2S.00-00/PK__**

Melamine Laquered Cabinets / Mobili in Melaminico Laccato

cod. **WRKQD2S.__-00/PK__**

€ **3.3047,00**

€ **4.474,00**

WORKSTATION 2027 SX L-VERSION 180



Workstation with 2027 structure, cabinet consisting of module with sliding doors and lock, 1 partition and 1 shelf per compartment, open module with 1 shelf. Wraparound work desktop white colour, thickness 22mm.
Stazione di lavoro con struttura 2027, mobile composto da modulo con ante scorrevoli e serratura, 1 tramezza e 1 ripiano per vano, modulo a giorno con 1 ripiano. Piano scrivania di lavoro avvolgente di colore bianco, spessore 22mm.

Melamine Laquered Cabinets Colors
Colori Laccati Mobili Melaminico



Frame colors
Colori struttura



Melamine Cabinets Color
Colore Mobili Melaminico



Laminated top color
Colori piano laminato

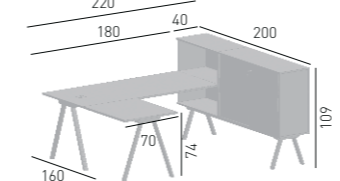

Unassembled structure, individual modules assembled.
Struttura non assemblata, singoli moduli assemblati.



1,12 m³
129,5 kg.

Finishing & Codes / Finiture e Codici

Melamine Cabinets / Mobili in Melaminico

cod. **WRKML1S.00-00/PK__**

Melamine Laquered Cabinets / Mobili in Melaminico Laccato

cod. **WRKQL1S.__-00/PK__**

€ **3.534,00**

€ **4.628,00**

WORKSTATION 2027 DX L-VERSION 240



Workstation with 2027 structure, cabinet consisting of module with sliding doors and lock, 1 partition and 1 shelf per compartment, open module with 1 shelf. Wraparound work desktop white colour, thickness 22mm.
Stazione di lavoro con struttura 2027, mobile composto da modulo con ante scorrevoli e serratura, 1 tramezza e 1 ripiano per vano, modulo a giorno con 1 ripiano. Piano scrivania di lavoro avvolgente di colore bianco, spessore 22mm.

Melamine Laquered Cabinets Colors
Colori Laccati Mobili Melaminico



Frame colors
Colori struttura

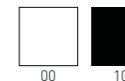

Melamine Cabinets Color
Colore Mobili Melaminico



Laminated top color
Colori piano laminato

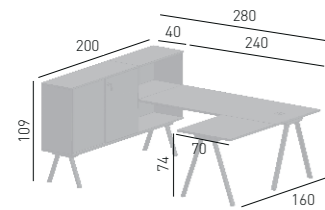

Unassembled structure, individual modules assembled.
Struttura non assemblata, singoli moduli assemblati.



1,17 m³
139,5 kg.

Finishing & Codes / Finiture e Codici

Melamine Cabinets / Mobili in Melaminico
cod. **WRKML2D.00-00/PK__**
Melamine Laquered Cabinets / Mobili in Melaminico Laccato
cod. **WRKQL2D.__-00/PK__**

€ **3.798,00**
€ **5.324,00**

WORKSTATION 2027 DX VERSION 180 WITH BENCH



Workstation with 2027 structure, cabinet consisting of module with sliding doors and lock, 1 partition and 1 shelf per compartment, open module with 1 shelf. Straight desktop white colour, thickness 22mm. Bench module with padded and upholstered seats.
Stazione di lavoro con struttura 2027, mobile composto da modulo con ante scorrevoli e serratura, 1 tramezza e 1 ripiano per vano, modulo a giorno con 1 ripiano. Piano scrivania di lavoro dritta di colore bianco, spessore 22mm. Modulo panca con sedute imbottite e tappezzate.

BENCH module available coverings / Finiture disponibili modulo panca

King fabric / Tessuto King **K**
Aurea eco-leather / Ecopelle Aurea **E**
Blazer fabric / Tessuto Blazer **B**
Leather / Pelle **P**
Kvadrat fabrics / Tessuti Kvadrat **DK**

Melamine Laquered Cabinets Colors
Colori Laccati Mobili Melaminico



Frame colors
Colori struttura



Melamine Cabinets Color
Colore Mobili Melaminico



Laminated top color
Colori piano laminato

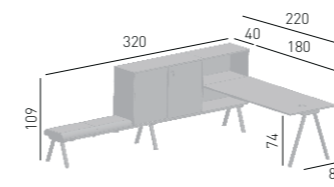

Unassembled structure, individual modules assembled.
Struttura non assemblata, singoli moduli assemblati.



1,14 m³
122,1 kg.

Finishing & Codes / Finiture e Codici

Melamine Cabinets / Mobili in Melaminico
cod. **WRKMD1DP.00-00-_(K)/PK__** € **3.840,00**
cod. **WRKMD1DP.00-00-_(E)/PK__** € **3.840,00**
cod. **WRKMD1DP.00-00-_(B)/PK__** € **3.960,00**
cod. **WRKMD1DP.00-00-_(P)/PK__** € **4.324,00**
cod. **WRKMD1DP.00-00-_(DK)/PK__** € **4.324,00**
Melamine Laquered Cabinets / Mobili in Melaminico Laccato
cod. **WRKQD1DP.__-00-_(K)/PK__** € **4.980,00**
cod. **WRKQD1DP.__-00-_(E)/PK__** € **4.980,00**
cod. **WRKQD1DP.__-00-_(B)/PK__** € **5.102,00**
cod. **WRKQD1DP.__-00-_(P)/PK__** € **5.222,00**
cod. **WRKQD1DP.__-00-_(DK)/PK__** € **5.222,00**

WORKSTATION 2027 SX L-VERSION 240



Workstation with 2027 structure, cabinet consisting of module with sliding doors and lock, 1 partition and 1 shelf per compartment, open module with 1 shelf. Wraparound work desktop white colour, thickness 22mm.
Stazione di lavoro con struttura 2027, mobile composto da modulo con ante scorrevoli e serratura, 1 tramezza e 1 ripiano per vano, modulo a giorno con 1 ripiano. Piano scrivania di lavoro avvolgente di colore bianco, spessore 22mm.

Melamine Laquered Cabinets Colors
Colori Laccati Mobili Melaminico



Frame colors
Colori struttura



Melamine Cabinets Color
Colore Mobili Melaminico



Laminated top color
Colori piano laminato

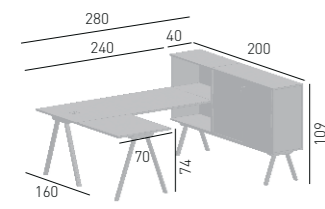

Unassembled structure, individual modules assembled.
Struttura non assemblata, singoli moduli assemblati.



1,17 m³
139,5 kg.

Finishing & Codes / Finiture e Codici

Melamine Cabinets / Mobili in Melaminico
cod. **WRKML2S.00-00/PK__**
Melamine Laquered Cabinets / Mobili in Melaminico Laccato
cod. **WRKQL2S.__-00/PK__**

€ **3.798,00**
€ **5.324,00**

WORKSTATION 2027 SX VERSION 180 WITH BENCH



Workstation with 2027 structure, cabinet consisting of module with sliding doors and lock, 1 partition and 1 shelf per compartment, open module with 1 shelf. Straight desktop white colour, thickness 22mm. Bench module with padded and upholstered seats.
Stazione di lavoro con struttura 2027, mobile composto da modulo con ante scorrevoli e serratura, 1 tramezza e 1 ripiano per vano, modulo a giorno con 1 ripiano. Piano scrivania di lavoro dritta di colore bianco, spessore 22mm. Modulo panca con sedute imbottite e tappezzate.

BENCH module available coverings / Finiture disponibili modulo panca

King fabric / Tessuto King **K**
Aurea eco-leather / Ecopelle Aurea **E**
Blazer fabric / Tessuto Blazer **B**
Leather / Pelle **P**
Kvadrat fabrics / Tessuti Kvadrat **DK**

Melamine Laquered Cabinets Colors
Colori Laccati Mobili Melaminico



Frame colors
Colori struttura



Melamine Cabinets Color
Colore Mobili Melaminico



Laminated top color
Colori piano laminato

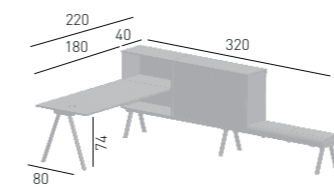

Unassembled structure, individual modules assembled.
Struttura non assemblata, singoli moduli assemblati.



1,14 m³
122,1 kg.

Finishing & Codes / Finiture e Codici

Melamine Cabinets / Mobili in Melaminico
cod. **WRKMD1SP.00-00-_(K)/PK__** € **3.840,00**
cod. **WRKMD1SP.00-00-_(E)/PK__** € **3.840,00**
cod. **WRKMD1SP.00-00-_(B)/PK__** € **3.960,00**
cod. **WRKMD1SP.00-00-_(P)/PK__** € **4.324,00**
cod. **WRKMD1SP.00-00-_(DK)/PK__** € **4.324,00**
Melamine Laquered Cabinets / Mobili in Melaminico Laccato
cod. **WRKQD1SP.__-00-_(K)/PK__** € **4.980,00**
cod. **WRKQD1SP.__-00-_(E)/PK__** € **4.980,00**
cod. **WRKQD1SP.__-00-_(B)/PK__** € **5.102,00**
cod. **WRKQD1SP.__-00-_(P)/PK__** € **5.222,00**
cod. **WRKQD1SP.__-00-_(DK)/PK__** € **5.222,00**

WORKSTATION 2027 DX VERSION 240 WITH BENCH



Workstation with 2027 structure, cabinet consisting of module with sliding doors and lock, 1 partition and 1 shelf per compartment, open module with 1 shelf. Straight desktop white colour, thickness 22mm. Bench module with padded and upholstered seats.
Stazione di lavoro con struttura 2027, mobile composto da modulo con ante scorrevoli e serratura, 1 tramezza e 1 ripiano per vano, modulo a giorno con 1 ripiano. Piano scrivania di lavoro diritta di colore bianco, spessore 22mm. Modulo panca con sedute imbottite e tappezzate.

BENCH module available coverings / Finiture disponibili modulo panca
King fabric / Tessuto King **K**
Aurea eco-leather / Ecopelle Aurea **E**
Blazer fabric / Tessuto Blazer **B**
Leather / Pelle **P**
Kvadrat fabrics / Tessuti Kvadrat **DK**

Melamine Laquered Cabinets Colors
Colori Laccati Mobili Melaminico

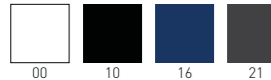

Frame colors
Colori struttura

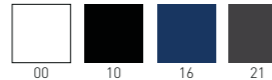

Melamine Cabinets Color
Colore Mobili Melaminico



Laminated top color
Colori piano laminato

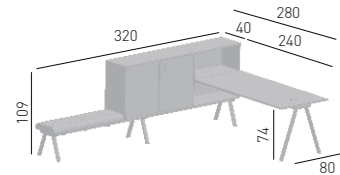

Unassembled structure, individual modules assembled.
Struttura non assemblata, singoli moduli assemblati.



1,14 m³
132,1 kg.

Finishing & Codes / Finiture e Codici
Melamine Cabinets / Mobili in Melaminico

cod. **WRKMD2DP.00-00-[K]/PK** € **4.164,00**
cod. **WRKMD2DP.00-00-[E]/PK** € **4.164,00**
cod. **WRKMD2DP.00-00-[B]/PK** € **4.286,00**
cod. **WRKMD2DP.00-00-[P]/PK** € **4.406,00**
cod. **WRKMD2DP.00-00-[DK]/PK** € **4.406,00**

Melamine Laquered Cabinets / Mobili in Melaminico Laccato

cod. **WRKQD2DP.00-00-[K]/PK** € **5.292,00**
cod. **WRKQD2DP.00-00-[E]/PK** € **5.292,00**
cod. **WRKQD2DP.00-00-[B]/PK** € **5.412,00**
cod. **WRKQD2DP.00-00-[P]/PK** € **5.534,00**
cod. **WRKQD2DP.00-00-[DK]/PK** € **5.534,00**

WORKSTATION 2027 X VERSION 180



Double workstation with 2027 structure, 2 cabinets consisting of modules with sliding doors and lock, 1 partition and 1 shelf per compartment, 1 open module with 1 shelf. Straight desktop white colour, thickness 22mm.
Stazione di lavoro doppia con struttura 2027, 2 mobili composto da moduli con ante scorrevoli e serratura, 1 tramezza e 1 ripiano per vano, 1 modulo a giorno con 1 ripiano. Piani scrivania di lavoro diritti di colore bianco, spessore 22mm.

Melamine Laquered Cabinets Colors
Colori Laccati Mobili Melaminico



Frame colors
Colori struttura

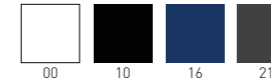

Melamine Cabinets Color
Colore Mobili Melaminico



Laminated top color
Colori piano laminato

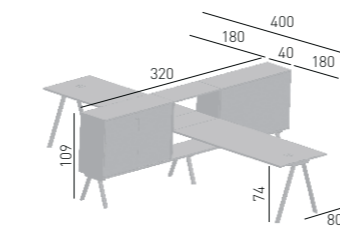

Unassembled structure, individual modules assembled.
Struttura non assemblata, singoli moduli assemblati.



1,75 m³
188,1 kg.

Finishing & Codes / Finiture e Codici

Melamine Cabinets / Mobili in Melaminico

cod. **WRKMX1.00-00/PK** € **5.374,00**

Melamine Laquered Cabinets / Mobili in Melaminico Laccato

cod. **WRKQX1.00-00/PK** € **7.142,00**

WORKSTATION 2027 SX VERSION 240 WITH BENCH



Workstation with 2027 structure, cabinet consisting of module with sliding doors and lock, 1 partition and 1 shelf per compartment, open module with 1 shelf. Straight desktop white colour, thickness 22mm. Bench module with padded and upholstered seats.
Stazione di lavoro con struttura 2027, mobile composto da modulo con ante scorrevoli e serratura, 1 tramezza e 1 ripiano per vano, modulo a giorno con 1 ripiano. Piano scrivania di lavoro diritta di colore bianco, spessore 22mm. Modulo panca con sedute imbottite e tappezzate.

BENCH module available coverings / Finiture disponibili modulo panca
King fabric / Tessuto King **K**
Aurea eco-leather / Ecopelle Aurea **E**
Blazer fabric / Tessuto Blazer **B**
Leather / Pelle **P**
Kvadrat fabrics / Tessuti Kvadrat **DK**

Melamine Laquered Cabinets Colors
Colori Laccati Mobili Melaminico



Frame colors
Colori struttura



Melamine Cabinets Color
Colore Mobili Melaminico



Laminated top color
Colori piano laminato

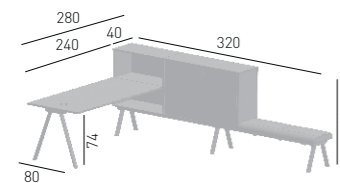

Unassembled structure, individual modules assembled.
Struttura non assemblata, singoli moduli assemblati.



1,14 m³
132,1 kg.

Finishing & Codes / Finiture e Codici
Melamine Cabinets / Mobili in Melaminico

cod. **WRKMD2SP.00-00-[K]/PK** € **4.164,00**
cod. **WRKMD2SP.00-00-[E]/PK** € **4.164,00**
cod. **WRKMD2SP.00-00-[B]/PK** € **4.286,00**
cod. **WRKMD2SP.00-00-[P]/PK** € **4.406,00**
cod. **WRKMD2SP.00-00-[DK]/PK** € **4.406,00**

Melamine Laquered Cabinets / Mobili in Melaminico Laccato

cod. **WRKQD2SP.00-00-[K]/PK** € **5.292,00**
cod. **WRKQD2SP.00-00-[E]/PK** € **5.292,00**
cod. **WRKQD2SP.00-00-[B]/PK** € **5.412,00**
cod. **WRKQD2SP.00-00-[P]/PK** € **5.534,00**
cod. **WRKQD2SP.00-00-[DK]/PK** € **5.534,00**

WORKSTATION 2027 X VERSION 240



Double workstation with 2027 structure, 2 cabinets consisting of modules with sliding doors and lock, 1 partition and 1 shelf per compartment, 1 open module with 1 shelf. Straight desktop white colour, thickness 22mm.
Stazione di lavoro doppia con struttura 2027, 2 mobili composto da moduli con ante scorrevoli e serratura, 1 tramezza e 1 ripiano per vano, 1 modulo a giorno con 1 ripiano. Piani scrivania di lavoro diritti di colore bianco, spessore 22mm.

Melamine Laquered Cabinets Colors
Colori Laccati Mobili Melaminico



Frame colors
Colori struttura



Melamine Cabinets Color
Colore Mobili Melaminico



Laminated top color
Colori piano laminato

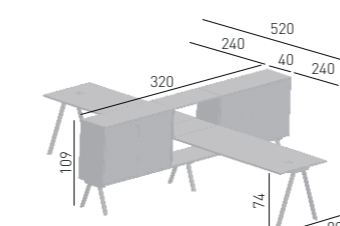

Unassembled structure, individual modules assembled.
Struttura non assemblata, singoli moduli assemblati.



1,79 m³
208,1 kg.

Finishing & Codes / Finiture e Codici

Melamine Cabinets / Mobili in Melaminico

cod. **WRKMX2.00-00/PK** € **6.028,00**

Melamine Laquered Cabinets / Mobili in Melaminico Laccato

cod. **WRKQX2.00-00/PK** € **7.946,00**

Cabinets



To store files and folders in a world of colours. These filing cabinets are suspended, on frames, for easy obstruction-free cleaning. The cabinets themselves, tough and resistant, come with quick and effective assembly fixings. Drawers: On castors and fitted, these simple pieces help keep workspaces tidy and stationery in place.

Per contenere, archiviare e classificare, in un mondo a colori. I mobili contenitori sono sospesi, su strutture a cavalletto, per una semplice pulizia anche automatica. Le strutture, solide e resistenti, sono provviste di sistemi di assemblaggio veloci e sicuri.

Cassettiere: Su ruote e attrezzate, questi semplici complementi aiutano a contenere e ordinare le piccole necessità dell'ufficio.

Finishings / Finiture

Melamine Laquered Cabinets Colors
(Antibacterial water-base laquering)
Colori Laccati Mobili Melaminico
(Laccatura antibatterica a base acqua)

Frame colors
Colori struttura

Melamine Cabinets Color
Colore Mobili Melaminico

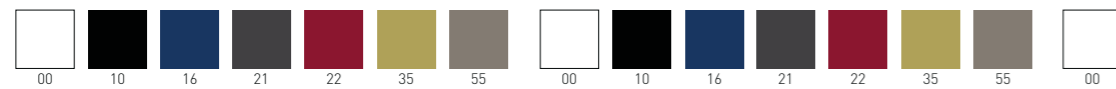

White Matte Laquered Neve (00) / Black Matte Laquered (10) / Blue Matte Laquered 5003 (16) / Grey Matte Laquered Antracite (21) / Bordeaux Matte Laquered 3004 (22) / Lime Matte Laquered Limone (35) / Mineral Grey Matte Laquered 7006 (55)

LOW CABINET 2027



Cabinet consisting of 2027 structure, 1 module with sliding doors and lock, 1 partition and 1 shelf per compartment, module with 2 filing cabinets. On request it is possible to replace the module with two filing cabinets with two drawers module. Maximum load on each sliding filing cabinet Kg. 20.

Mobile composto da struttura 2027, modulo con ante scorrevoli e serratura, 1 tramezza e 1 ripiano per vano, modulo con 2 classificatori. Su richiesta, è possibile sostituire il modulo a due classificatori con il modulo a due cassetti estraibili. Carico massimo su ogni classificatore estraibile Kg.20.

Melamine Laquered Cabinets Colors
Colori Laccati Mobili Melaminico

Frame colors
Colori struttura

Melamine Cabinets Color
Colore Mobili Melaminico

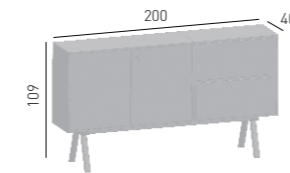

Unassembled structure, individual modules assembled.
Struttura non assemblata, singoli moduli assemblati.

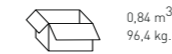

0,84 m³
96,4 kg.

Finishing & Codes / Finiture e Codici

Melamine Cabinets / Mobili in Melaminico

cod. CABMLC.00/PK__

Melamine Laquered Cabinets / Mobili in Melaminico Laccato

cod. CABQLC.__/PK__

€ 3.058,00

€ 4.306,00

CABINET 2027



Cabinet consisting of 2027 structure and module with sliding doors and lock, 1 Partition and 2 shelves per compartment.

Mobile composto da struttura 2027 e modulo con ante scorrevoli e serratura, 1 tramezza e 2 ripiani per vano.

Melamine Laquered Cabinets Colors
Colori Laccati Mobili Melaminico

Frame colors
Colori struttura

Melamine Cabinets Color
Colore Mobili Melaminico

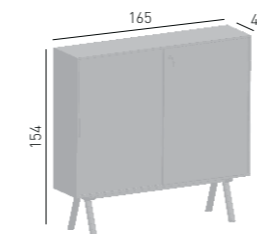

Unassembled structure, individual modules assembled.
Struttura non assemblata, singoli moduli assemblati.



1,03 m³
87,9 kg.

Finishing & Codes / Finiture e Codici

Melamine Cabinets / Mobili in Melaminico

cod. CABMCC.00/PK__

Melamine Laquered Cabinets / Mobili in Melaminico Laccato

cod. CABQCC.__/PK__

€ 2.318,00

€ 3.894,00

MULTIPLE CABINET 2027



Cabinet consisting of 2027 structure and two modules with sliding doors and lock, 1 Partition and 2 shelves per compartment.
Mobile composto da struttura 2027 e 2 moduli con ante scorrevoli e serratura, 1 tramezza e 2 ripiani per vano.

Melamine Laquered Cabinets Colors
Colori Laccati Mobili Melaminico



Frame colors
Colori struttura



Melamine Cabinets Color
Colore Mobili Melaminico

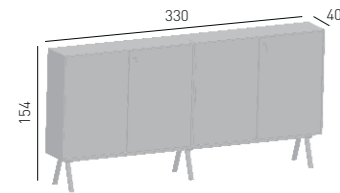

Unassembled structure, individual modules assembled.
Struttura non assemblata, singoli moduli assemblati.



2,01 m³
163,9 kg.

Finishing & Codes / Finiture e Codici

Melamine Cabinets / Mobili in Melaminico
cod. CABMMC.00/PK__
Melamine Laquered Cabinets / Mobili in Melaminico Laccato
cod. CABQMC.__/PK__

€ **4.588,00**
€ **7.740,00**

LOW CABINET 2027 + SEATER



Cabinet consisting of 2027 structure, 1 module with sliding doors and lock, 1 partition and 1 shelf per compartment, upholstered service seats.
Mobile composto da struttura 2027, modulo con ante scorrevoli e serratura, 1 tramezza e 1 ripiano per vano, sedute imbottite di servizio.

Melamine Laquered Cabinets Colors
Colori Laccati Mobili Melaminico

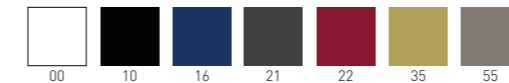

Frame colors
Colori struttura

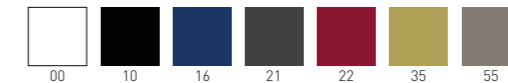

Melamine Cabinets Color
Colore Mobili Melaminico

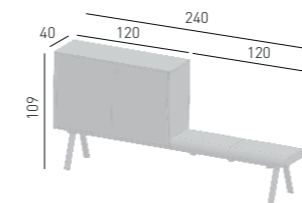

Unassembled structure, individual modules assembled.
Struttura non assemblata, singoli moduli assemblati.



0,55 m³
61,90 kg.

Finishing & Codes / Finiture e Codici

Melamine Cabinets / Mobili in Melaminico
cod. CABMLP.00-_(K)/PK__
cod. CABMLP.00-_(E)/PK__
cod. CABMLP.00-_(B)/PK__
cod. CABMLP.00-_(P)/PK__
cod. CABMLP.00-_(DK)/PK__

€ **2.396,00**
€ **2.396,00**
€ **2.516,00**
€ **2.638,00**
€ **2.638,00**

Melamine Laquered Cabinets / Mobili in Melaminico Laccato

cod. CABQLP.__-_(K)/PK__
cod. CABQLP.__-_(E)/PK__
cod. CABQLP.__-_(B)/PK__
cod. CABQLP.__-_(P)/PK__
cod. CABQLP.__-_(DK)/PK__

€ **3.102,00**
€ **3.102,00**
€ **3.224,00**
€ **3.224,00**
€ **3.224,00**

HIGH CABINET 2027



Cabinet consisting of 2027 structure, two modules with sliding doors and locks, 1 partition and 1 shelf per compartment, module with 2 filing cabinets, open module with 1 shelf. On request it is possible to replace the module with two filing cabinets with two drawers module. Maximum load on each sliding filing cabinet Kg. 20.
Mobile composto da struttura 2027, due moduli con ante scorrevoli e serrature, 1 tramezza e 1 ripiano per vano, modulo con 2 classificatori, modulo a giorno con 1 ripiano. Su richiesta, è possibile sostituire il modulo a due classificatori con il modulo a due cassetti estraibili. Carico massimo su ogni classificatore estraibile Kg.20.

Melamine Laquered Cabinets Colors
Colori Laccati Mobili Melaminico



Frame colors
Colori struttura



Melamine Cabinets Color
Colore Mobili Melaminico

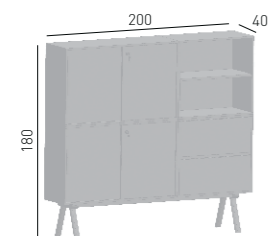

Unassembled structure, individual modules assembled.
Struttura non assemblata, singoli moduli assemblati.



1,54 m³
161,4 kg.

Finishing & Codes / Finiture e Codici

Melamine Cabinets / Mobili in Melaminico
cod. CABMHC.00/PK__
Melamine Laquered Cabinets / Mobili in Melaminico Laccato
cod. CABQHC.__/PK__

€ **4.824,00**
€ **7.316,00**

DRAWER



Drawer on rubber wheels with lock. 3 drawers plus office product bin.
Cassetiera su ruote gommate con serratura. 3 cassetti più portacancelleria.

Melamine Laquered Drawer Colors
Colori Laccati Cassetiera Melaminico

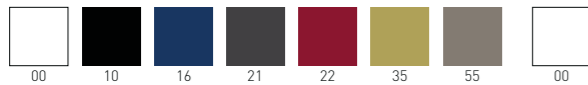

Melamine Drawer Color
Colore Cassetiera Melaminico

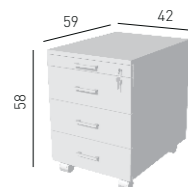

A assembled / assemblata



0.14 m³
28 kg.

Finishing & Codes / Finiture e Codici

Melamine Cabinets / Mobili in Melaminico

cod. **CABMDR.00/A**

Melamine Laquered Cabinets / Mobili in Melaminico Laccato

cod. **CABQDR._/A**

€ **722,00**

€ **1.138,00**



Display wall or floor fixed storage shelving can enhance your most ambitious projects. Available with a black, gold or white matt painted steel frame, without any visible welds, Display is set off with solid Fenix laminate shelves. Display is a modular piece, which can support up to 4 shelves and lends itself to completing and finely decorating walls and corners of your commercial spaces. For correct use, the structure must be fixed to the wall or floor.

Semplice ed elegante, Display decorerà con discrezione i vostri progetti più ambiziosi. Disponibile con struttura in acciaio verniciato nero, oro o bianco opaco, senza nessuna saldatura a vista, è impreziosito da solidi ripiani in laminato Fenix. Display è un elemento modulare, che può sostenere sino a 4 mensole e si presta a completare e decorare con raffinatezza pareti ed angoli dei vostri spazi commerciali. Per un corretto utilizzo, questo mobile deve essere fissato alla parete o pavimento.

Finishings / Finiture

Frame colors / Colori struttura



Fenix laminated top color / Colori piano laminato Fenix

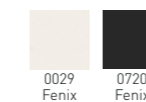

DISPLAY



Frame colors / Colori struttura

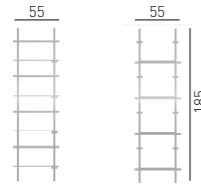
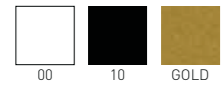

Single metal frame "Display", matt painted.
Struttura singola in metallo verniciato opaco "Display"

NA not assembled / non assemblato



0,63 m³ - 22 kg.
55x35x185cm.
1 pcs [carton]

Frame Finishing & Codes / Finiture Telai e Codici

cod. ACCV020. __

€ 1.304,00

Fenix laminated top color / Colori piano laminato Fenix

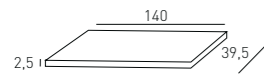
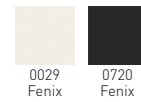

Laminated shelve "Display".
Mensola in laminato "Display"

NA not assembled / non assemblato



0,16 m³ - 9,50 kg.
1 pcs [carton]

Frame Finishing & Codes / Finiture Telai e Codici

Cod. PTL460. __ lam.fenix

€ 462,00

DISPLAY EXAMPLE OF USE



ACOUSTIC Collection



Collection certified UNI EN ISO 354:2003, sound absorption A Class following UNI EN ISO 11654:1998. The Collection is certified ASTM E84-16 for surface burning characteristics of building materials (UL723, UBC 8-1, NFPA 255). The collection is certified Class 1 Reaction to Fire following UNI 8457:1987-UNI 8457/A1:1996 and UNI 9174:1987-UNI 9174/A1:1996. Collezione certificata UNI EN ISO 354:2003, Classe A di assorbimento acustico secondo la norma UNI EN ISO 11654: 1998. La collezione è certificata ASTM E84-16 secondo le caratteristiche di resistenza al fuoco dei materiali da costruzione (UL723, UBC 8-1, NFPA 255). La collezione è certificata Classe 1 seguendo le norme UNI 8457:1987-UNI 8457/A1:1996 and UNI 9174:1987-UNI 9174/A1:1996 per la resistenza al fuoco.

Standard colors
Colori standard

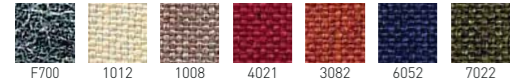

On demand, minimum 52 pcs - surcharge 28 € each unit
Gestione su commessa quantità minima 52 pz - prezzo 28 € per unità



STILLY FLAT

Sound-absorbing system.
Sistema di pannelli fonoassorbenti.

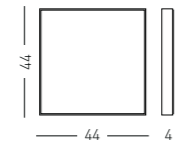

0,040 m³ - 2,95 kg.
47x45x19cm.
4 pcs [carton]

Finishing & Codes / Finiture e Codici

cod.PASTF.--
cod.PASTFB.-- led version

€ 84,00
€ 300,00

STILLY PYRAMID

Sound-absorbing system.
Sistema di pannelli fonoassorbenti.

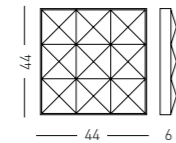

0,040 m³ - 2,95 kg.
47x45x19cm.
4 pcs [carton]

Finishing & Codes / Finiture e Codici

cod.PASTP.--
cod.PASTPB.-- led version

€ 84,00
€ 300,00

Fono



Standard colors
Colori standard



FONO A

Sound-absorbing system.
Sistema di pannelli fonoassorbenti.

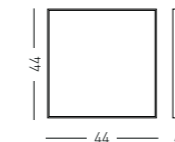

0,040 m³ - 2,95 kg.
47x45x19cm.
4 pcs [carton]

Finishing & Codes / Finiture e Codici

cod.PAFOA.--

€ 96,00

FONO B

Sound-absorbing system.
Sistema di pannelli fonoassorbenti.

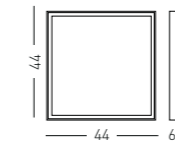

0,055 m³ - 3,20 kg.
47x45x26cm.
4 pcs [carton]

Finishing & Codes / Finiture e Codici

cod.PAFOB.--

€ 96,00

FONO C

Sound-absorbing system.
Sistema di pannelli fonoassorbenti.

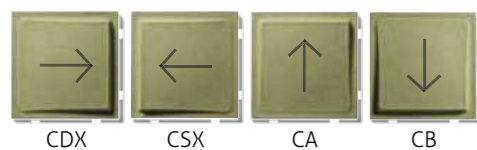

CDX CSX CA CB

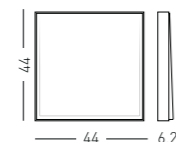

0,047 m³ - 3,10 kg.
47x45x22cm.
4 pcs [carton]

Finishing & Codes / Finiture e Codici

cod.PAFOCA.--
cod.PAFOCB.--
cod.PAFOCDX.--
cod.PAFOCSX.--

€ 96,00
€ 96,00
€ 96,00
€ 96,00

FONO D

Sound-absorbing system.
Sistema di pannelli fonoassorbenti.



DDX DSX DA DB

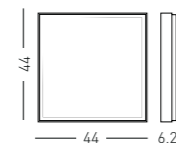

0,047 m³ - 3,10 kg.
47x45x22cm.
4 pcs [carton]

Finishing & Codes / Finiture e Codici

cod.PAFODA.--
cod.PAFODB.--
cod.PAFODDX.--
cod.PAFODSX.--

€ 96,00
€ 96,00
€ 96,00
€ 96,00



Collection certified UNI EN ISO 354:2003, sound absorption C Class following UNI EN ISO 11654:1998.
Collezione certificata UNI EN ISO 354:2003, Classe C di assorbimento acustico secondo la norma UNI EN ISO 11654: 1998.

UNIKO FLAT

Sound-absorbing system for false ceiling.
Sistema di pannelli fonoassorbenti per controsoffitti.

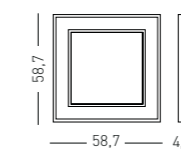

0,060 m³ - 3,7 kg.
61x61x16cm.
3 pcs [carton]

Finishing & Codes / Finiture e Codici

cod.PAUKF.--

€ 106,00

Standard colors / Colori standard

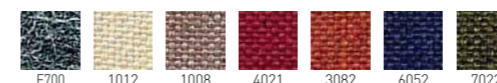

UNIKO PYRAMID

Sound-absorbing system for false ceiling.
Sistema di pannelli fonoassorbenti per controsoffitti.

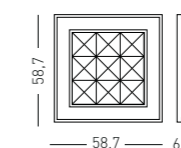

0,060 m³ - 3,7 kg.
61x61x16cm.
3 pcs [carton]

Finishing & Codes / Finiture e Codici

cod.PAUKP.--

€ 106,00

Standard colors / Colori standard

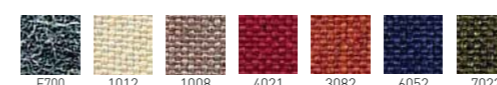

UNIKO 4

Sound-absorbing system for false ceiling.
Sistema di pannelli fonoassorbenti per controsoffitti.

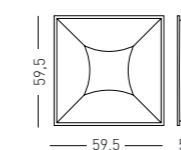

0,060 m³ - 6,4 kg.
61x61x16cm.
10 pcs [carton]

Finishing & Codes / Finiture e Codici

cod.PAUK4.-- Uniko 4 Coverings

€ 96,00

Uniko 4 coverings colors / Uniko 4 colori tessuti

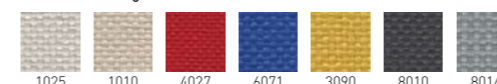



Madison 4 coverings colors / Madison 4 colori tessuti



MADISON 4

Sound-absorbing system for false ceiling.
Sistema di pannelli fonoassorbenti per controsoffitti.

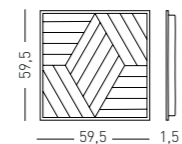

0,060 m³ - 6,5 kg.
61x61x16cm.
10 pcs [carton]

Finishing & Codes / Finiture e Codici

cod.PAMA4.-- Madison 4 Coverings

€ 102,00

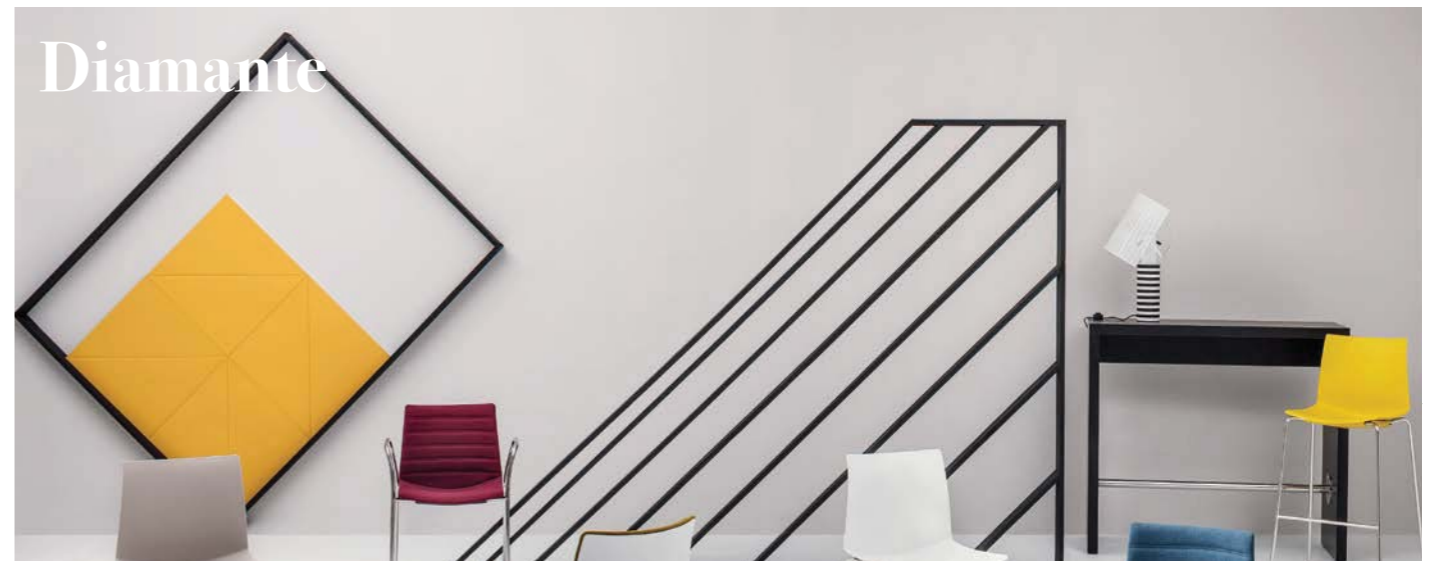

Collection certified UNI EN ISO 354:2003, sound absorption A Class following UNI EN ISO 11654:1998.
Collezione certificata UNI EN ISO 354:2003, Classe A di assorbimento acustico secondo la norma UNI EN ISO 11654: 1998.

Diamante 4 / Diamante Double 4 / Diamante Spotlight X2 / X4 Coverings



Frame colors

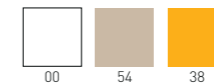

DIAMANTE 4

Diamante sound-absorbing panels.
Pannelli fonoassorbenti Diamante.

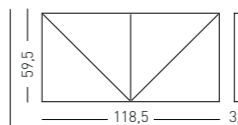

0,11 m³ - 12 kg.
123x62x16cm.
4 pcs [carton]

Finishing & Codes / Finiture e Codici

cod.PADI4.-- Diamante 4 Coverings

€ 242,00

Diamante 4 customized printed panel
Pannello Diamante 4 personalizzato stampato
(min 4pcs)

€ 790,00

DIAMANTE DOUBLE 4

Diamante sound-absorbing panels with double coverings.
Pannelli fonoassorbenti Diamante con doppia copertura.

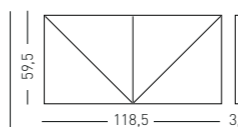

0,12 m³ - 15,7 kg.
123x62x16cm.
4 pcs [carton]

Finishing & Codes / Finiture e Codici

cod.PADI4D.-- Diamante Double 4 Coverings

€ 352,00

Diamante 4 Double customized printed panel
Pannello Diamante 4 Double personalizzato stampato (min 4pcs)

€ 880,00

DIAMANTE SPOTLIGHT X2

Sound-absorbing panel with integrated lighting kit (2 led).
Pannello fonoassorbente con kit illuminazione integrato (2 led).



Only with ACCV005 horizontal suspension kit.
Solo con ACCV005 kit sospensione orizzontale.

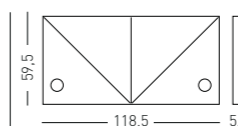

0,12 m³ - 9 kg.
123x62x16cm.
2 pcs [carton]

Finishing & Codes / Finiture e Codici

cod.PADLX2.--

€ 382,00

DIAMANTE SPOTLIGHT X4



Sound-absorbing panel with integrated lighting kit (4 led).
Pannello fonoassorbente con kit illuminazione integrato (4 led).

Only with ACCV005 horizontal suspension kit.
Solo con ACCV005 kit sospensione orizzontale.

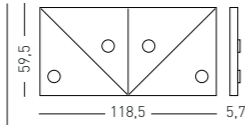

0,12 m³ - 9 kg.
123x62x16cm.
2 pcs [carton]

Finishing & Codes / Finiture e Codici

cod.PADLX4.--

€ 524,00

DIAMANTE VERTICAL SUSPENSION

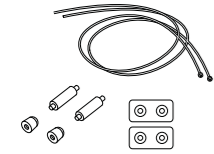

Vertical suspension optional kit, length 3m.
Kit opzionale sospensione verticale, lunghezza 3m.

Codes / Codici

ACCV004

€ 70,00

DIAMANTE HORIZONTAL SUSPENSION

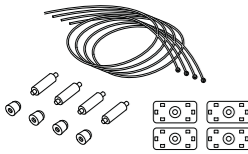

Horizontal suspension optional kit, length 3m.
Kit opzionale sospensione orizzontale, lunghezza 3m.

Codes / Codici

ACCV005

€ 184,00

DIAMANTE PEDESTAL

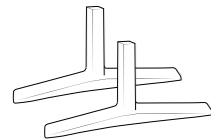

2 white legs pedestal optional kit.
Kit opzionale 2 gambe piedistallo bianche.

Codes / Codici

ACCV006.00 white/bianco

€ 44,00

DIAMANTE PARTITION LEG



Screen partition optional kit.
Kit opzionale divisorio.

Codes / Codici

ACCV007

€ 110,00

DIAMANTE WALL FIXING

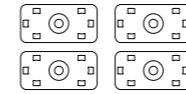

Wall fixing optional kit.
Kit opzionale fissaggio a parete.

Codes / Codici

ACCV008

€ 80,00

DIAMANTE LIGHTING SYSTEM

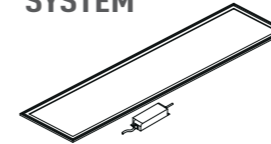

Horizontal suspension lighting system kit.
Kit di illuminazione per sospensione orizzontale.

Codes / Codici

ACCV009

€ 568,00

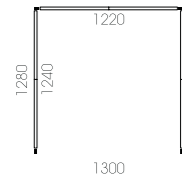

DIAMANTE PARTITION A

0,50 m³ - 32 kg.
1 pcs (carton)

Finishing & Codes / Finiture e Codici

cod.PAPADA.--

€ **2.552,00**

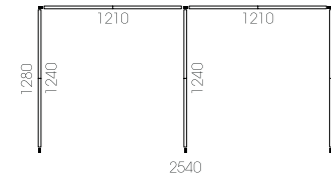
DIAMANTE PARTITION B

0,60 m³ - 52 kg.
1 pcs (carton)

Finishing & Codes / Finiture e Codici

cod.PAPADB.--

€ **4.180,00**

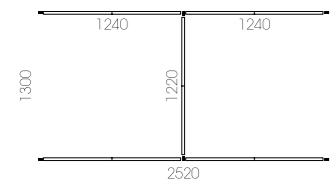
DIAMANTE PARTITION C

0,60 m³ - 52 kg.
1 pcs (carton)

Finishing & Codes / Finiture e Codici

cod.PAPADC.--

€ **4.180,00**

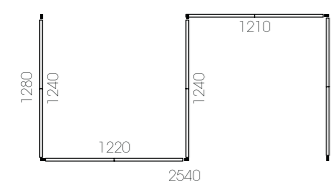
DIAMANTE PARTITION D

0,60 m³ - 52 kg.
1 pcs (carton)

Finishing & Codes / Finiture e Codici

cod.PAPADD.--

€ **4.18,00**

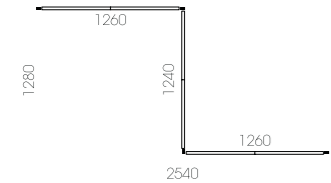
DIAMANTE PARTITION E

0,50 m³ - 32 kg.
1 pcs (carton)

Finishing & Codes / Finiture e Codici

cod.PAPADE.--

€ **2.552,00**

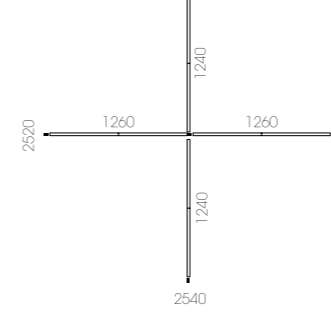
DIAMANTE PARTITION F

0,50 m³ - 44 kg.
1 pcs (carton)

Finishing & Codes / Finiture e Codici

cod.PAPADF.--

€ **3.366,00**

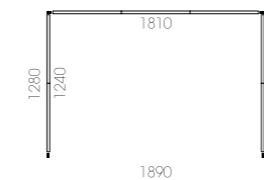
DIAMANTE PARTITION A2

0,50 m³ - 36 kg.
1 pcs (carton)

Finishing & Codes / Finiture e Codici

cod.PAPADA2.--

€ **2.904,00**

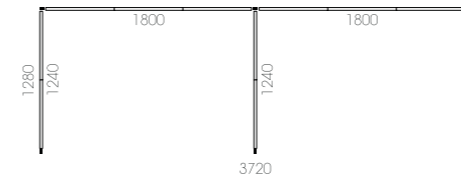
DIAMANTE PARTITION B2

0,60 m³ - 60 kg.
1 pcs (carton)

Finishing & Codes / Finiture e Codici

cod.PAPADB2.--

€ **4.884,00**

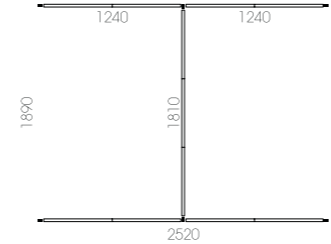
DIAMANTE PARTITION C2

0,60 m³ - 56 kg.
1 pcs (carton)

Finishing & Codes / Finiture e Codici

cod.PAPADC2.--

€ **4.532,00**

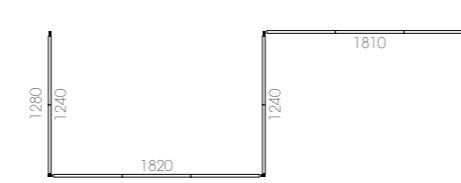
DIAMANTE PARTITION D2

0,60 m³ - 60 kg.
1 pcs (carton)

Finishing & Codes / Finiture e Codici

cod.PAPADD2.--

€ **4.884,00**



Collection certified UNI EN ISO 354:2003, sound absorption A Class following UNI EN ISO 11654:1998.
 Collezione certificata UNI EN ISO 354:2003, Classe A di assorbimento acustico secondo la norma UNI EN ISO 11654: 1998.

Standard colors
 Colori standard

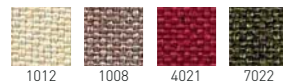

PIUMA 55

Sound-absorbing system.
 Sistema di pannelli fonoassorbenti.



0,06 m³ - 4 kg.
 45x80x16cm.
 4 pcs [carton]

Finishing & Codes / Finiture e Codici

cod.PAPI55. __

€ 190,00

PIUMA 65

Sound-absorbing system.
 Sistema di pannelli fonoassorbenti.

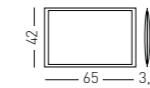

0,06 m³ - 5 kg.
 45x80x16cm.
 4 pcs [carton]

Finishing & Codes / Finiture e Codici

cod.PAPI65. __

€ 198,00

PIUMA 75

Sound-absorbing system.
 Sistema di pannelli fonoassorbenti.

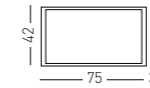

0,06 m³ - 6 kg.
 45x80x16cm.
 4 pcs [carton]

Finishing & Codes / Finiture e Codici

cod.PAPI75. __

€ 206,00

PIUMA 150

Sound-absorbing system.
 Sistema di pannelli fonoassorbenti.

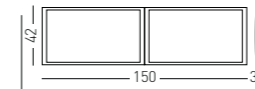

0,13 m³ - 12 kg.
 45x80x35cm.
 4 pcs [carton]

Finishing & Codes / Finiture e Codici

cod.PAPI150. __

€ 412,00

PIUMA BRACKET

Piuma bracket support, adjustable till 64mm table thickness.
 Staffa di fissaggio pannello Piuma, regolabile sino ad uno spessore tavolo di 64mm.



Included on Piuma panels packaging.
 Inclusa nell'imballo pannelli Piuma.

Finishing & Codes / Finiture e Codici

cod.ACCV016.00 white/bianco

€ 72,00



TUNE Free-Standing

The sound-absorbing free-standing panels of the Tune collection are designed both to furnish with elegance as well as to assure the precise function of reducing sound reverberation. Equipped with a matt painted metal base, they are made of polyester fiber and available in two different sizes.

I pannelli fonoassorbenti free-standing della famiglia Tune sono pensati per arredare con eleganza, nella precisa funzione di ridurre il riverbero sonoro. Dotati di basamento in metallo verniciato opaco, sono realizzati in fibra di poliestere e disponibili in due diverse dimensioni.

Finishings / Finiture



TUNE FREE-STANDING 80



Frame colors / Colori struttura



Standard colors / Colori standard

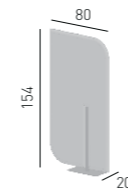
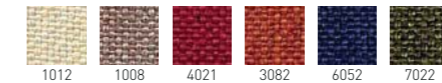

NA not assembled / non assemblato



0,125 m³ - 15,5 kg.
159x110x7cm.
1 pcs [carton]

Frame Finishing & Codes / Finiture Telai e Codici

cod. PATNS80_[FRAME]_[FABRIC]

€ 970,00

TUNE FREE-STANDING 100



Frame colors / Colori struttura



Standard colors / Colori standard

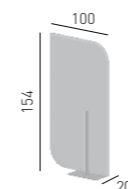
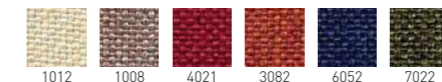

NA not assembled / non assemblato



0,125 m³ - 16,5 kg.
159x110x7cm.
1 pcs [carton]

Frame Finishing & Codes / Finiture Telai e Codici

cod. PATNS100_[FRAME]_[FABRIC]

€ 998,00



TUNE Desk Settings

TUNE DESK SETTINGS 80

"Tune" acoustic panel, with white bracket kit for desk settings.
Pannello Fonoassorbente "Tune", con kit staffe fissaggio a scrivania colore bianco.



Bracket color / Colore staffa fissaggio



Standard colors / Colori standard

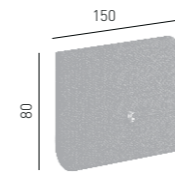
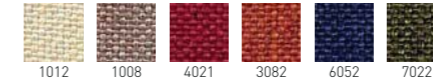

NA not assembled / non assemblato



0,125 m³ - 10 kg.
159x110x7cm.
1 pcs (carton)

Frame Finishing & Codes / Finiture Telai e Codici

cod. PATND80.00-_____

€ **766,00**

The sound-absorbing panels of the Tune collection fixed to the desk tops are practical screens to enhance privacy, improving acoustic comfort, facilitating concentration and well-being in the workplace.

I pannelli fonoassorbenti della famiglia Tune fissati ai piani delle scrivanie come pratici schermi per valorizzare la privacy, migliorano il comfort acustico, agevolando la concentrazione e il benessere nell'ambito degli ambienti di lavoro.

Finishings / Finiture

Bracket color / Colore staffa fissaggio



Standard colors / Colori standard

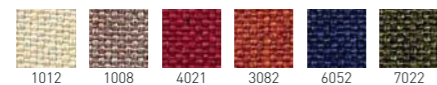

Onda



Culture

Malene Flensted Urup Design

Ø50 or Ø70 cm aluminum planter, black painted, complete with suspension column, available in customize length between 100cm to 240cm.
Vaso in alluminio Ø50 o Ø70 cm, verniciato nero, completo di colonna di sospensione, disponibile in lunghezze personalizzate da 100cm a 240cm



Frame Color / Colore Struttura



Finishing Finiture



ONDA



Onda fills of persona-lity any environments, decorating and lighting them, even improving acoustic comfort.
Onda riempie di carattere gli ambienti, decorandoli, illuminandoli e fungendo anche da elemento fonoassorbente.

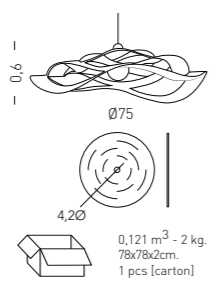

Finishing & Codes / Finiture e Codici

- cod.LAON2.FB-F700
- cod.LAON2.FB-F032
- cod.LAON2.FB-F065

€ 352,00
€ 352,00
€ 352,00

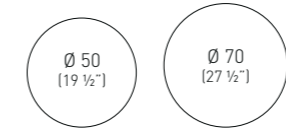
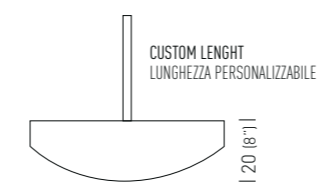

diam.50
diam.70

1500/NAN
1501/NAN

0.20m³ / 10kg / 1pcs
0.20m³ / 11kg / 1pcs

€ 1.598,00
€ 1.936,00

ACCESSORIES

White Lamp Holder.
Portalampada Bianco.

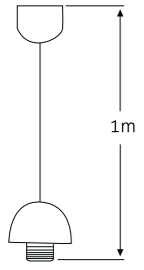

Finishing & Codes / Finiture e Codici

ACCV003

€ 44,00



Flaire

Studio Eurolinea Design

Techno-polymer Lamp collection
with diffused shine effect.
Collezione di lampade in materiale
plastico con effetto a bagliore diffuso.

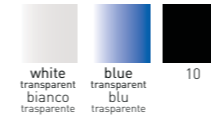

49.--

0.1m³ / 11kg / 1pcs

€ 256,00

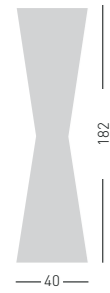

CE



230V - 50Hz
1 X 16W - Led Modul
IP 65

Colors / Colori

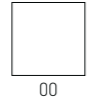

H182

2182/A

0.32m³ / 15kg / 1pcs

€ 1.424,00

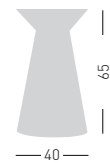

CE



230V - 50Hz
1 X 16W - Led Modul
IP 65

Colors / Colori

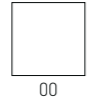

H65

2065/A

0.14m³ / 12kg / 1pcs

€ 774,00

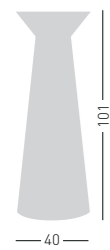

CE



230V - 50Hz
1 X 16W - Led Modul
IP 65

Colors / Colori

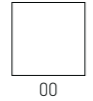

H101

2101/A

0.21m³ / 14kg / 1pcs

€ 992,00

ACCESSORIES ACCESSORI

CHAIR CONNECTIONS / GANCI PER UNIRE LE SEDIE



1000
for models Maya, Tulip and Iris
per modelli Maya, Tulip e Iris

€ 10,00



1002
for models with frame Ø 16mm
per modelli con telaio Ø 16mm

€ 10,00



1001
for model Compact
per modello Compact

€ 10,00



1005
for Models Kanvas ST
per modelli Kanvas ST

€ 10,00



All glides
tutti i tipi di tappi
€ 2,00

TABLE LINKING DEVICE / AGGANCIO PER TAVOLI



Cod. 1100
Metal-Technopolymer Linking device KIT (male+female), suitable for Laminated table tops (22 or 25 mm), complete with screws and pre-drilled holes on table-tops. Not assembled.
KIT Aggancio in Metallo-Tecnopolimero (maschio+femmina), adatto a piani in Laminato (22 o 25 mm), completo di viti e pre-forature sui piani. Non assemblato.

€ 140,00 1 Kit allow the complete connection between two tables.
1 Kit permette la connessione completa di due tavoli.

TABLET STAND / SUPPORTO TABLET

Technopolymer Tablet stand supports all top-selling tablets and smartphones in both portrait or landscape positions. The tablet stand fit perfectly all Compactop Surfaces, both 11 or 12 mm thick.
Accessorio in tecnopolimero per supportare i più venduti tablet o smartphones, sia in posizione verticale che orizzontale, è utilizzabile su superfici in Compactop, in entrambi gli spessori 11 e 12mm.



Available Color / Colori disponibili



cod. 1103.G1

0.005m³ / 5kg / 50pcs

€ 16,00

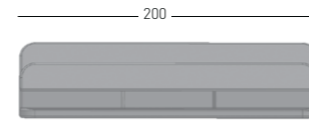

POWER UNIT / UNITÀ DI ELETTTRIFICAZIONE

The Power Unit includes a power socket (Schuko), a USB type A+C port and 2meter connection cable. Thanks to its stand-alone base, the power unit can fixed by screws or can be placed anywhere on the worktop without any limits, allowing the user to get the power wherever is needed. Thanks to a suspension braket the power unit can be easily mounted upside-down the worksurface, in order to keep free your desk.

Il sistema di elettrificazione da scrivania include una presa energia (Schuko), le porte USB A+C, e due metri di cavo di connessione. La sua base d'appoggio consente di essere fissata con viti o posizionata senza alcun vincolo al piano, offrendo la libertà di utilizzo ovunque ci sia una esigenza di collegamento. Il fissaggio sotto piano per mezzo di un'apposita staffa permette di liberare le superfici d'appoggio, in questo modo si può sfruttare al massimo lo spazio della superficie di lavoro.



Available Color / Colori disponibili

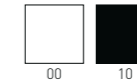

cod. ACCV040.00 white/bianco
cod. ACCV040.10 black/nero

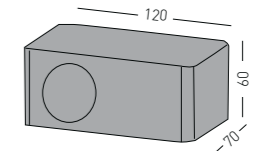

0.06m³ / 7.5kg / 8pcs
0.06m³ / 7.5kg / 8pcs

€ 424,00
€ 424,00



GABER TOOL BOX

The technopolymer Gaber Tool Box is a practical desk organiser. The Tool Box stacks perfectly and is available in a wide range of trendy vibrant color. Gaber Tool Box è un pratico raccoglitore di oggetti per la scrivania. Il Tool Box si impila perfettamente, ed è disponibile in una vasta gamma di moderni colori.



Available Color / Colori disponibili

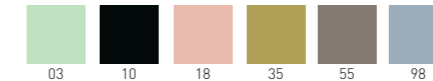

cod. ACCV011.____



0.015m³ / 0.6kg / 2pcs

€ 22,00

GABER CLEANING KIT / KIT DI PULIZIA GABER

Excellent solution in order to keep the best cleaning on table tops, technopolymer chairs and stools, metal, aluminum and wooden surfaces. Ottima soluzione per mantenere al meglio la pulizia dei piani tavoli, sedie e sgabelli in tecnopolimero, superfici in metallo, legno e alluminio.



ACCV001

0.007m³ / 0.5kg / 1pcs

€ 40,00

Cleanig liquid + Cloth / Detergente liquido + Panno

COLOURS AND COVERINGS

COLORI E RIVESTIMENTI

Techno-polymer / Tecnopolimero



Metal finishes / Finiture metalli



COLOURS AND COVERINGS COLORI E RIVESTIMENTI

Bases and frames wooden finishes / Finiture legno basi e telai

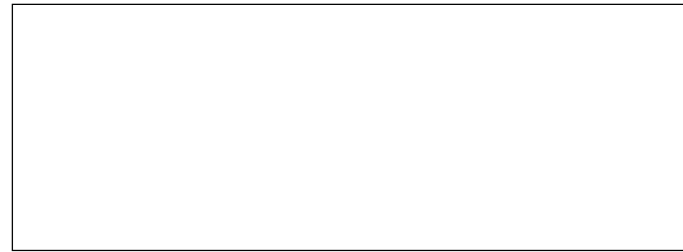

00 White stained / Bianco



F Natural Beech / Faggio naturale



RN Natural Oak / Rovere Naturale

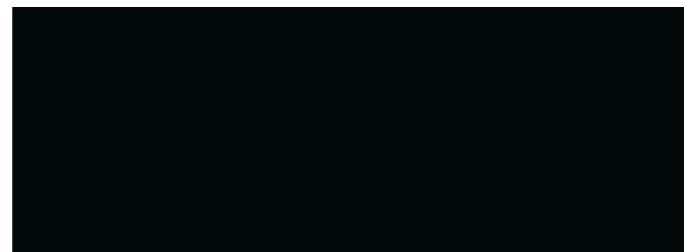

10 Black stained / Nero

F-00-10 finishes arise from Beech Essence. RN finish come from Oak Essence
Le finiture F-00-10 derivano da essenza di Faggio. La finitura RN deriva da essenza di Rovere.

Standard Compactop Surface

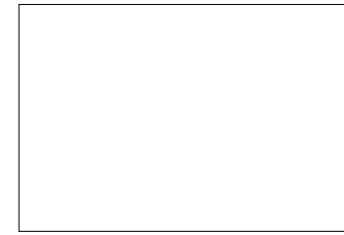

00



10



14

Special Compactop Surface Fenix - www.fenixforinteriors.com

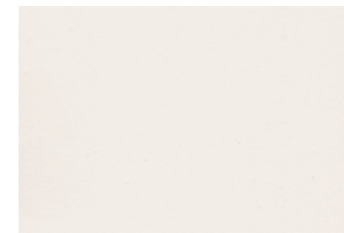

0029

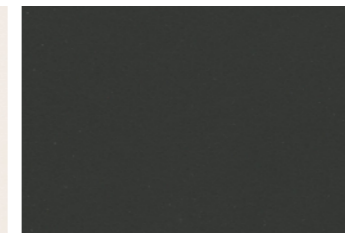

0720

Special Compactop Surface - Solid - www.arpaindustriale.com

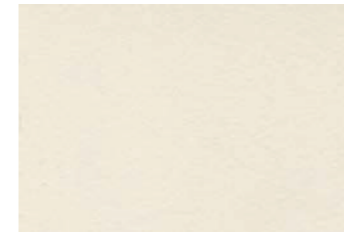

244

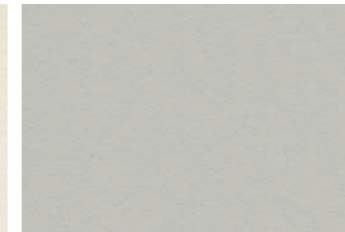

527

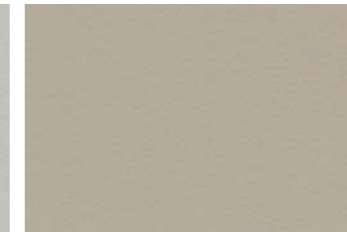

247

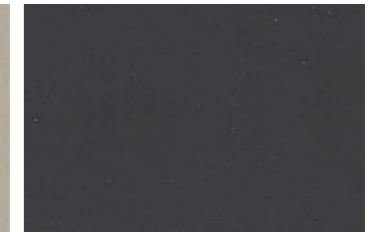

526

Special Compactop Surface - Wood Effect - www.arpaindustriale.com



4529



4543



4587



4511

COLOURS AND COVERINGS

COLORI E RIVESTIMENTI

Special Compactop Surface - Stone, Concrete and Marble Effect - www.arpainindustriale.com



3192

3349

3276

3329



5547

Special Compactop Surface - Marble Effect - www.lamicolor.it

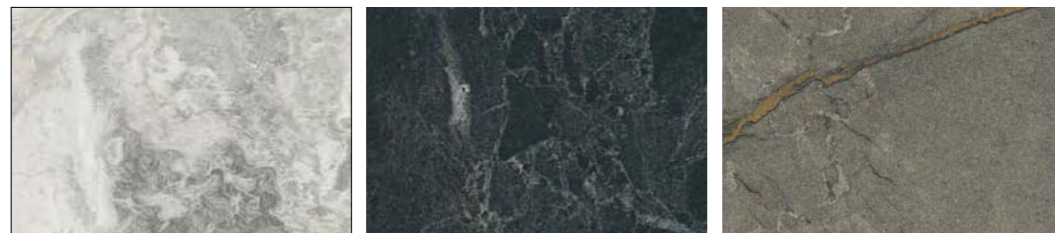

6075

6076

6089

Standard Laminated Surface



F

RN

W

00

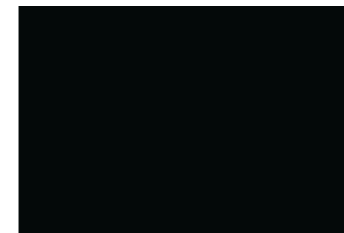

10

Special Laminated Surface - Wood Effect



B01

X41

61M

V32



WGB



WG9

Special Laminated Surface - Fenix - www.fenixforinteriors.com

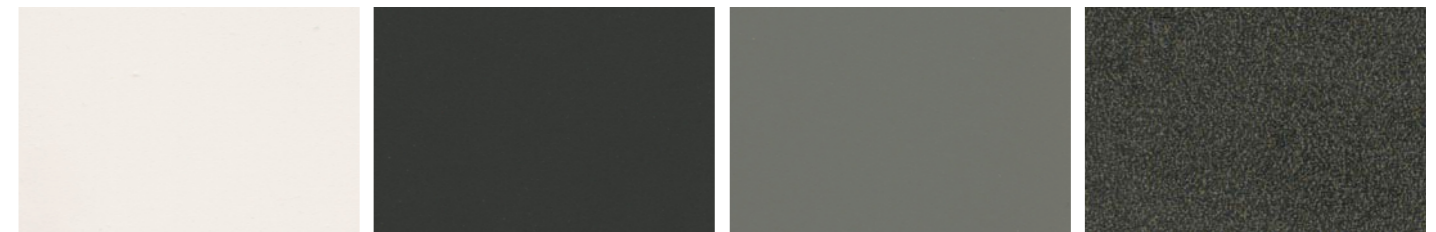

0029

720

718

2630



2629



2628

COLOURS AND COVERINGS

COLORI E RIVESTIMENTI

Marble Surface



MBC - BIANCO CARRARA

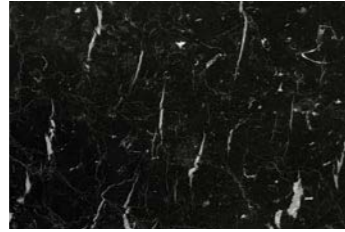

MNM - NERO MARQUINA



MVG - VERDE GUATEMALA

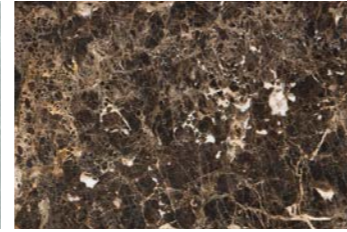

MED - EMPERADOR DARK

Porcelain Surface



PCO - CALACATTA ORO

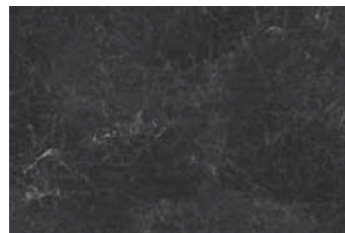

PNG - NERO GRECO

K King Fabric / Tessuto King



6001

6091

6034

6052

7019

7022

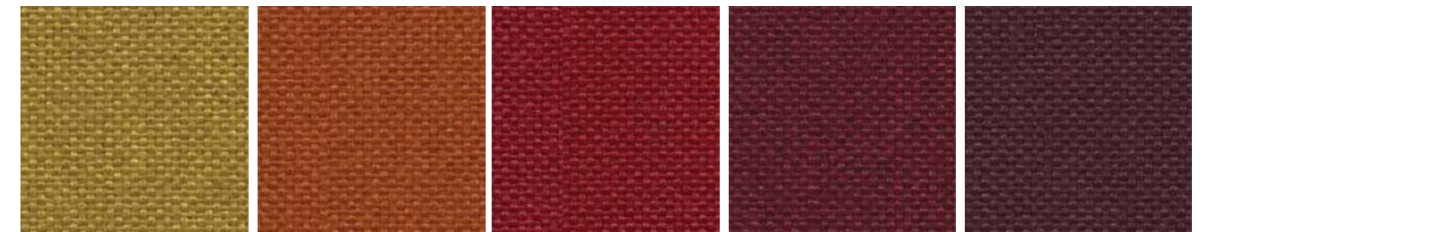

3030

3082

4021

4032

5001

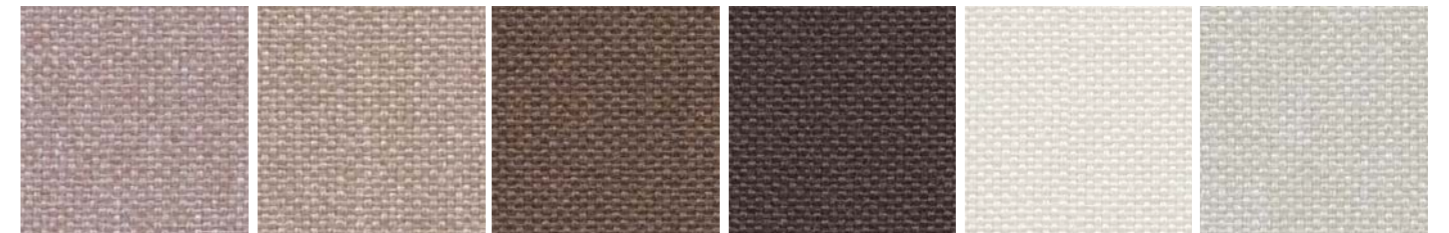

1033

1008

2003

2007

1012

1025

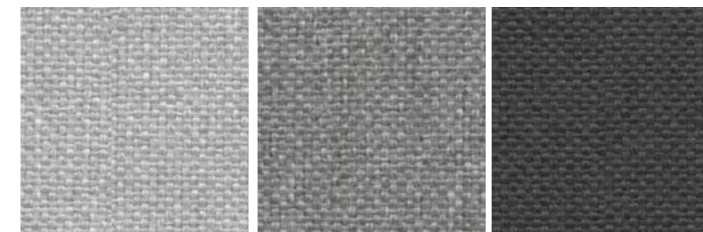

8032

8006

8011

- Composition: 100% POLYESTER - TREVIRA CS
- Abrasion: UNI EN ISO 12947-2 80.000 Cycle Martindale ±10%
- Light Resistance-Xenotest: UNI EN ISO 105-B02 / 6 (tol from 5 to 8)
- Fire proof: UNI 9174 - 8456 Class C1, UNI 9175 Class 1, DIN 4102 Class B1, NF 92501-7 Class M1, NF D 60013, 11M (UNI 9175) Class AM18, EN 1021-1 & 2, BS Crib 5, BS 7176 Class Medium Hazard, EN 13773 Class 1, OENORM 3800-1 Class B1,Q1,TR1, California TB117, USA NFPA 701, USA NFPA 260, IMO A 652 (16) Part 8 Upholstery
- Maintenance: Standard 60° C cotton cycle.

Visit www.fidivi.com for complete colours range / Visionate la completa gamma colori su www.fidivi.com

COLOURS AND COVERINGS COLORI E RIVESTIMENTI

L King L Fabric / Tessuto King L



6071

3090

4027

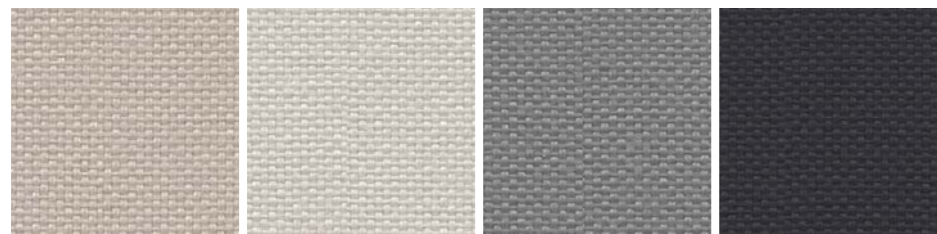

1010

1025

8014

8010

- Composition: 100% POLYESTER
- Abrasion: UNI EN ISO 12947/2 70.000 Cycle Martindale $\pm 10\%$
- Light Resistance-Xenotest: UNI EN ISO 105-B02 / 6 (tol from 5 to 8)
- Fire proof: UNI 9174 - 8456 Class C1, DIN 4102 Class B1, NF P 92501-7 Class M1, IMO Res. A652 (16), NF D 60013 Class AM18, EN 1021-1 & 2, BS 5852 part II Crib 5, BS 7176 Medium Hazard, ONORM B 3825-Onorm A 3800-1 Class B1-Q1-TR1, Euroclass EN 13501-1, EN 1021-1 & 2, 1IM (UNI 9175), California TB 117
- Maintenance: Use vacuum-cleaner, don't brush.

Visit www.fidivi.com for complete colours range / Visionate la completa gamma colori su www.fidivi.com

DK Kvadrat Fabric (Steelcut2) / Tessuto Kvadrat (Steelcut2)



835

760

780

950

975

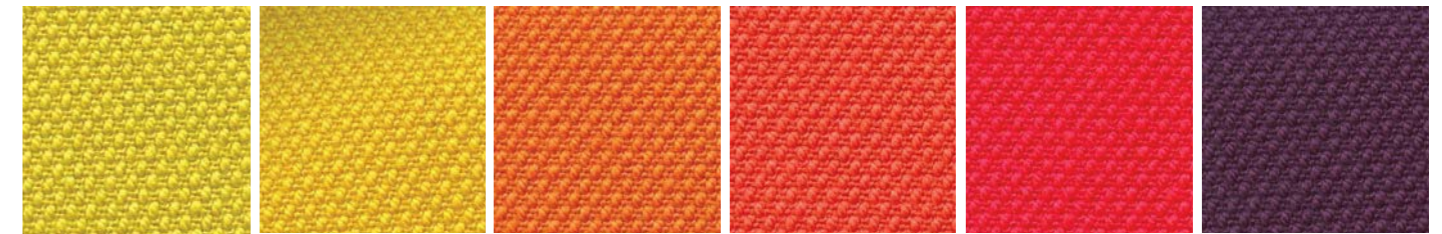

435

445

535

550

635

625



685

255

365

655

110

140



155

180

190

- Composition: 90% New wool worsted - 10% Nylon
- Abrasion: 100.000 Martindale rubs, EN ISO 12947
- Lightfastness: Note 5-7, ISO 105-B02
- AS/NZS 1530.3, BS 5852 crib 5 with treatment, BS 5852 part 1, IMO FTP Code 2010 Part 8, NF D 60 013, NFPA 260, SN 198 898 5.3 with treatment, UNI 9175 1IM, US Cal. Bull. 117-2013, EN 1021-1/2, AS/NZS 3837 class 2, ONORM B1/Q1, ASTM E84 Class A Unadhered, ASTM E84 Class B Adhered

Visit www.kvadrat.dk for complete colours range / Visionate la completa gamma colori su www.kvadrat.dk

COLOURS AND COVERINGS COLORI E RIVESTIMENTI

DK Kvadrat Fabric (Remix3) / Tessuto Kvadrat (Remix3)



733 722 743 753 923 942



672 982 973 612 422 632

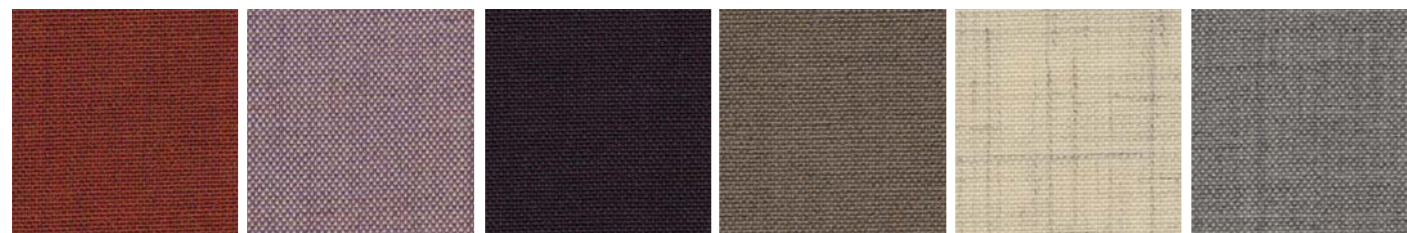

653 682 692 233 113 123



143 183

- Composition: 90% wool, 10% nylon
- Abrasion: Approximately 100.000 Martindale rubs, EN ISO 12947
- Lightfastness: Note 5-7, ISO 105-B02
- AS/NZS 1530.3, BS 5852 crib 5 with treatment, BS 5852 ignition source 3, BS 5852 part 1, IMO FTP Code 2010 Part 7 with treatment, IMO FTP Code 2010 Part 8, NF D 60 013, NFPA 260, SN 198 898 5.3 with treatment, UNI 9175 11M, US Cal. Bull. 117-2013, EN 1021-1/2, AS/NZS 3837 class 2, ÖNORM B1/Q1, ASTM E84 Class A Unadhered, ASTM E84 Class A Adhered, GB 50222 B1 with treatment

Visit www.kvadrat.dk for complete colours range / Visionate la completa gamma colori su www.kvadrat.dk

S Superb Trevira Fabric / Tessuto Velvet-Velluto



5130 5127 5131 5140 5134 5135

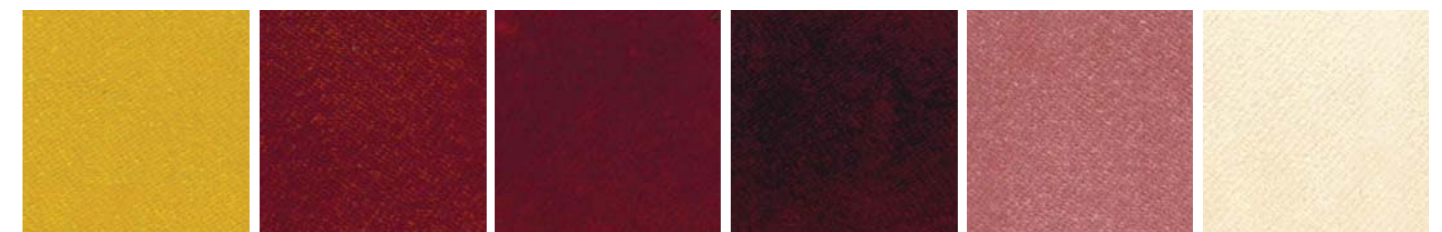

5106 5112 5118 5119 5114 5103



5144 5143 5149 5142 5145 5152

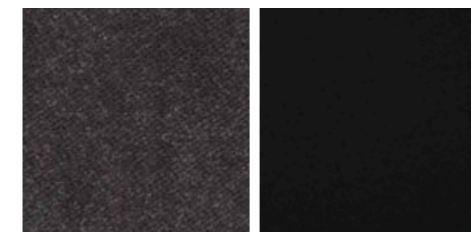

5151 5147

- Composition: 100% POLYESTER - TREVIRA CS
- Abrasion: UNI EN ISO 12947-2 100.000 Cycles
- Light Resistance-Xenotest: UNI EN ISO 105-B02 ≥ 5 Blue Scale
- Fire proof: UNI 8456 - 9174 classe 1, UNI 9175 classe 11M, EN 1021-1 EN 1021-2, BS 5852 crib 5, DIN 4102 B1, NF P 92 503-507 M1, TB 117:2013 UNI EN 13773:2004 classe 1, NFPA 701:2015
- Maintenance: Dust gently or pass the surface with a damp cloth.

Visit www.flukso.it for complete colours range / Visionate la completa gamma colori su www.flukso.it

COLOURS AND COVERINGS COLORI E RIVESTIMENTI

B Blazer Fabric / Tessuto Blazer



CUZ2Z

CUZ1E

CUZ86

CUZ47

CUZ1T

CUZ2R



CUZ3D

CUZ18

CUZ63

CUZ82

CUZ1N

CUZ1K

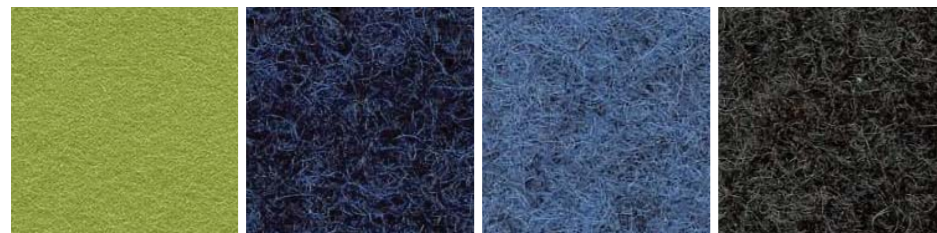

CUZ2X

CUZ62

CUZ1W

CUZ67

- Composition: 100% VIRGIN WOOL
- Abrasion: BS EN ISO 12497-2 65.000 Cycle Martindale
- Light Resistance-Xenotest: UNI EN ISO 105-B02 / 5
- Fire proof: BS EN 1021 Part 1, BS EN 1021 Part 2, BS 7176 Low Hazard, BS EN 13501-1:2007 Class D, NF D 60-013 AM18, UNI 9175:2010 Class 11M, BS476 part 7 Class 1, ONORM B 3825, IMOFTP Code (part 8)
- Maintenance: Use the vacuum-cleaner.

Visit www.camirafabrics.com for complete colours range / Visionate la completa gamma colori su www.camirafabrics.com

M Miki Fabric / Tessuto Miki

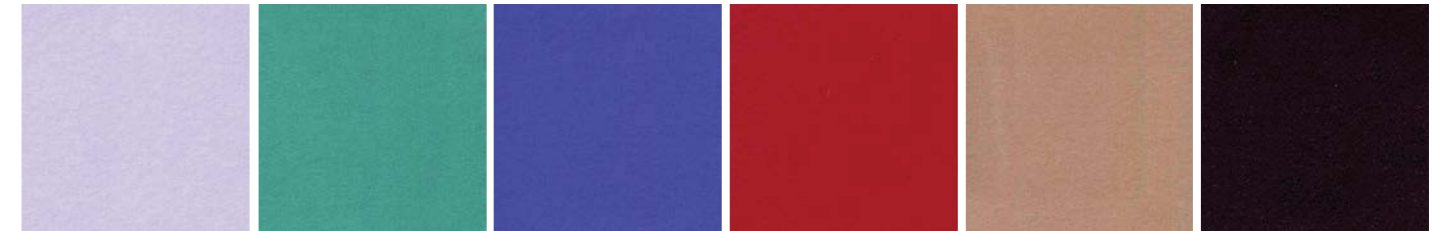

6445

6490

6713

6432

6334

NERO

- Composition: Composizione 100% PL 65/75 g/m² – Composition 100% PL 65/75 g/m²
- Light Resistance-Xenotest: UNI EN ISO 105-B02 / 01
- Maintenance: Dust with a soft and dry cloth.

COLOURS AND COVERINGS COLORI E RIVESTIMENTI

FO Fortezza 93 Fabric / Tessuto Fortezza 93

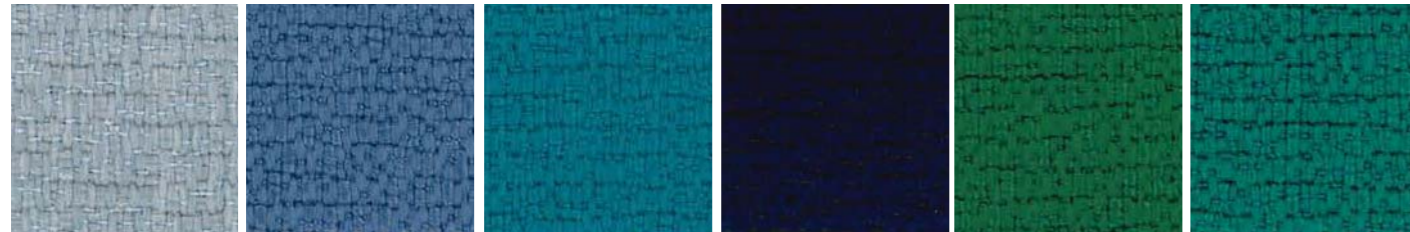

30-1 67-1 44-1 46-1 65-1 56-1

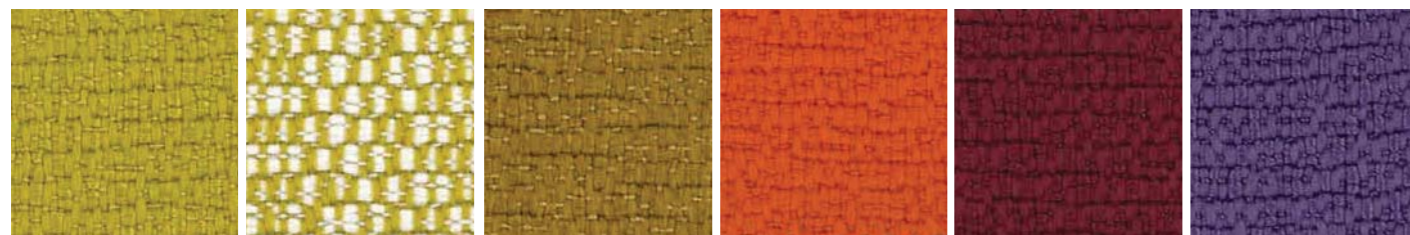

43-1 43-2 48-1 47-1 69-1 68-1



23-1 66-1 24-1 41-1 64-1 42-1



38-1 39-2 39-1 17-1 17-2

- Composition: 100% Polyolefinic
- Abrasion: UNI EN ISO 12947 35.000 rubs/cicli
- Seam slippage: BS 2543
- Pilling: UNI EN ISO 12945-2
- Colour fastness Dry Rubbing: UNI EN ISO 105-X12
- Colour fastness Wet Rubbing: UNI EN ISO 105-X12
- Light Fastness: UNI EN ISO 105-B02, UNI EN ISO 105-B04
- Colour Fastness to Sea Water: UNI EN ISO 105:E02:1996
- Colour Fastness to Chlorinated Water: UNI EN ISO 105:E03:2010
- Flammability: UNI 8456 - 9174 - CLASS 1 - ITALIAN FIRE SAFETY CLASSIFICATION - PASS, BS EN 1021.1:1994 - SOURCE 0 - CIGARETTE TEST - PASS, BS EN 1021.2:1994 - SOURCE 1 - BUTANE FLAME - PASS ON FR FOAM, T.B. 117 (2013); SECTION 1 POSITIVE, B1 ACCORDING TO DIN 4102, PART 1 (MAY 1998), NFPA 260:2013 - CLASS 1, IMO 2010 FTP CODE PART 8 - Resolution MSC 307(88) - Cigarette and Match Test, EN 13773 (2004) CLASS 1

Visit www.primafabrics.it for complete colours range / Visionate la completa gamma colori su www.primafabrics.it

GR Progarden Fabric / Tessuto Progarden



051 MEDITERRANEAN BLUE 026 PISTACHIO 028 OLIVE GREEN 012 LINEN 683 SLATE

- Composition: 100% yarn dyed acrylic
- Martindale (ISO 12947-2): 15.000 cycles
- Dimensional change after washing at 40°C and drying (warp/weft) (ISO 5077): ± 2%/0%
- Breaking strength (warp/weft) (ISO 13934-1): 200/70 daN
- Elongation at break (warp/weft) (ISO 13934-1): 25%/25%
- Tear strength (warp/weft) (ISO 13937-1): 7/3,7 daN
- Resistance to seam (warp/weft) (ISO 13935-1): 50/50 daN
- Air permeability (ISO 9237): 65 l/m²/s
- Finishing: Water repellent Teflon/Scotchgard treatment, dirt repellent and anti-mould treatment
- Spray Test (ISO 4920): 4 out of 5
- UV Colour fastness (ISO 105 B02): 5/8 out of 8
- Colour fastness to weather (ISO 105 B04): 5/8 out of 8
- Colour fastness after washing at 40°C (ISO 105 C06): 5 out of 5

Visit www.giovanardi.com for complete colours range / Visionate la completa gamma colori su www.giovanardi.com

SX Silvertex Fabric / Tessuto Silvertex

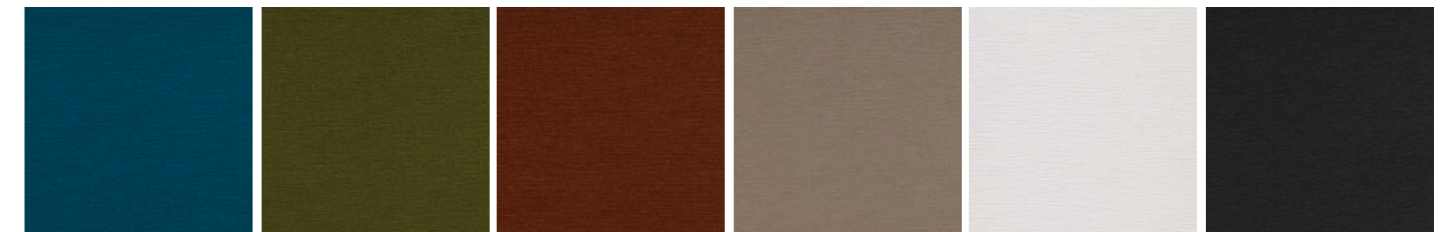

3066 BALTIC 5020 BASIL 1014 UMBER 0002 SANDSTONE 4004 ICE 4003 GRAPHITE

- Composition: 100% Vinyl / Polyester Backing
- Abrasion: >300.000 cycles Martindale (EN ISO 12947:1999 Part 2)
- UV Resistance: ISO 105 B04 ≥ 4/5 (Grey Scale), ISO 105 B02 ≥ 7/8 (Blue Wool Scale)
- Flame Retardancy: EU: EN 1021 Part 1 & 2
DE: DIN 4102 B2 ECE Regulation No.118:03 (R118.02 Annexes 6, 7 & 8), ES: UNE 23.727-90 1R/M.2, FR: NF P 92-503/M2, IT: UNI 9175 (1987) / UNI 9175/FA1 (1994)
Classe 1.1M (UNO I EMME), AT: ÖNORM B 3825, Gruppe 1 - Schwerbrennbares Verhalten, AT: ÖNORM A 3800 Teil 1, Qualmbildungsklasse Q1 - schwachqualmnd, IMO FTP 2010
Code MSC.307 (88) Part 8 3.1 & 3.2, (MED) Marine Equipment Directive (in its current valid version), EN 71-2:2006+A1:2007 - Safety of Toys - Parte 2: Flammability, US: CAL TB 117-2013, Section E, FMVSS 302, FAR 25/853

Visit www.spradling.eu for complete colours range / Visionate la completa gamma colori su www.spradling.eu

COLOURS AND COVERINGS COLORI E RIVESTIMENTI

R Mesh Fabric / Tessuto Rete

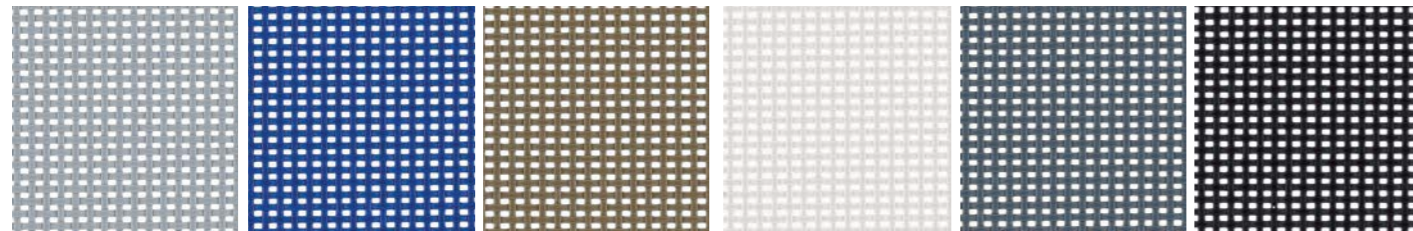

R08 R10 R09 R01 R03 R02

- Composition: Polyvinyl 70% - Polyester 30%
- Warp Tensile Strength: 310Kg/5cm
- Weft Tensile Strength: 270Kg/5cm
- Fire retardant on request

Visit www.plastitex.com for complete colours range / Visionate la completa gamma colori su www.plastitex.com

MG Maglia Vinyl Fabric / Tessuto Maglia Vinile



0003 0406 4203 5001 6025 4537



1702 6016

- Composition: Vynil 100%
- Abrasion: >100.000 cycles Martindale (EN ISO 12947:1999 Part 2)
- Fire Proof: EN 1021 Part 1 & 2, UNE 23.727-90 1R/M.2, NF P 92-503/M2, DIN 4102 B2, UNI 9175 (1987) / UNI 9175/FA1 (1994) Classe 1.IM (UNO I EMME), ÖNORM B 3825, Gruppe 1 - Schwerbrennbares Verhalten, ÖNORM A 3800 Teil 1, Qualmbildungsklasse Q1 - schwachqualmend, IMO FTP 2010 Code MSC.307 (88) Part 8 3.1 & 3.2, FMVSS 302, US: FAR 25/853, (MED) Marine Equipment Directive (in its current valid version), ECE R118.02 (replaces Directive 95/28/CE) Annexes 6, 7 & 8, EN 71-2:2006+A1:2007 - Safety of Toys - Parte 2: Flammability, CAL TB 117-2013, Section E
- Light Resistance: UV-Resistance XENOTEST DIN 54004/ NTC 1479

Visit www.spradling.eu for complete colours range / Visionate la completa gamma colori su www.spradling.eu

E Simil leather Aurea / Ecopelle Aurea



23 7 14 15 16 8



9 10 17 19 21 11



2 3 5 6



1 22 28 26

- Composition: 72% PVC - 3% PU - 25% COTTON
- Abrasion: EN ISO 5470-2 100.000 Cycle Martindale
- Light Resistance-Xenotest: UNI EN ISO 105-B02 / 6
- Fire proof: UNI 9175 classe 1IM, EN 1021-1, EN 1021-2, BS 5852-1 cigarette test, BS 5852-1 match test BS 5852 crib 5, TB 117:2013, IMO res. A.652(16)
- Maintenance: Dust gently or pass the surface with a damp cloth.

Visit www.flukso.it for complete colours range / Visionate la completa gamma colori su www.flukso.it

COLOURS AND COVERINGS

COLORI E RIVESTIMENTI

C Leather / Cuoio

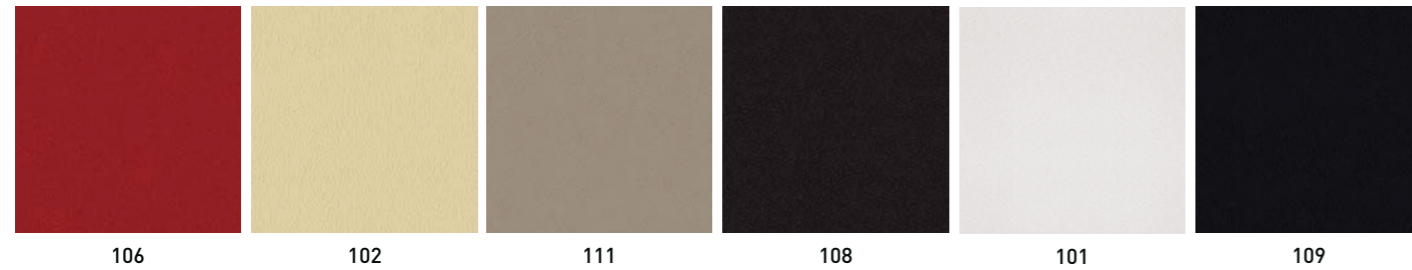

106

102

111

108

101

109

- Composition: 100% Grain Leather, Italian tannery
- Light Resistance: IUF/101
- Fire proof: CAL TB 117-00, Section E -part 1; BS 5852/90 section 4 (CRIB 5); UNI 91/75 Classe 2IM
- Maintenance: Dust gently or pass the surface with a damp cloth.

P Leather / Pelle

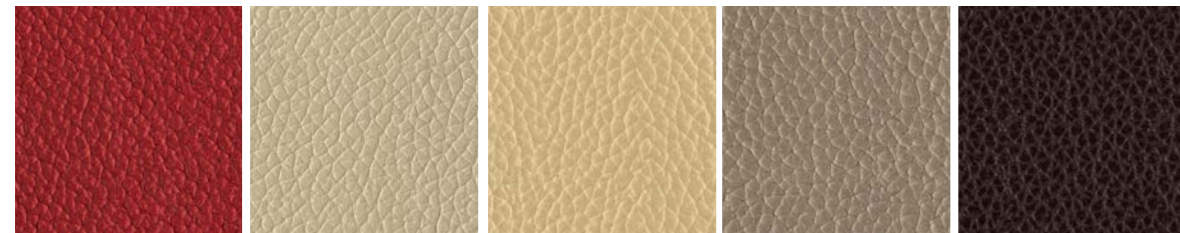

106P

102P

111P

110P

108P

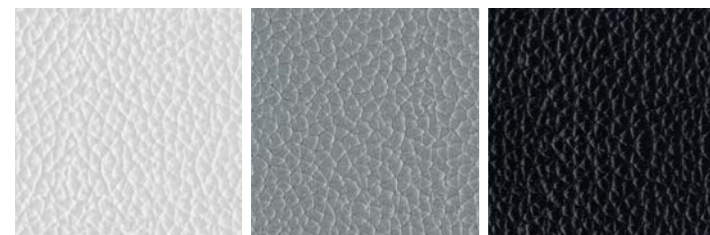

101P

112P

109P

- Composition: 100% Top Grain Leather, Italian tannery
- Light Resistance-Xenotest: UNI EN ISO 105-B02 / 6
- Fire proof: BS EN 1021 Part 1, BS 1021 Part 2, BS 5852 Part 2 (with special fire-retardant padding)
- Maintenance: Dust with a soft and dry cloth.



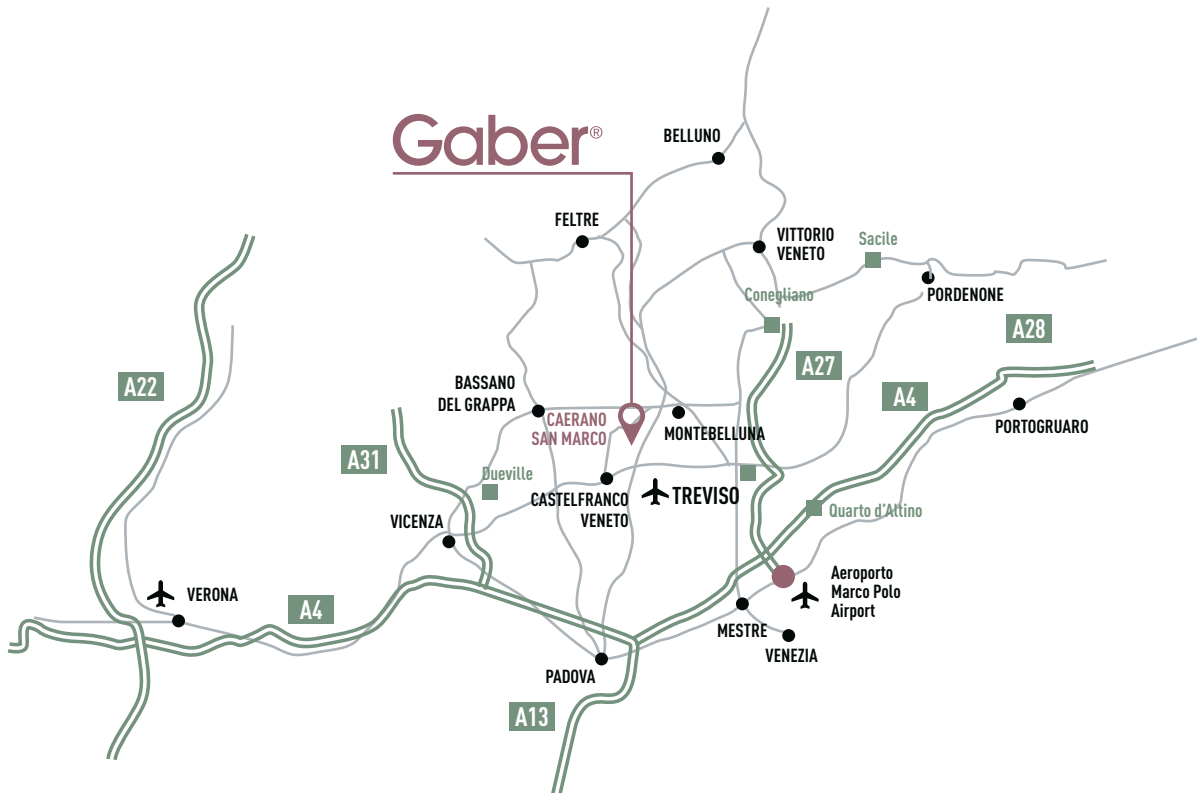

Gaber
Via Altivole, 3
31031 Caerano San Marco (TV)
ITALY
+39 0423 915521
info@gaber.it
gaber.it

Gaber®

visit us on gaber.it

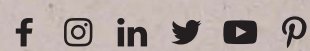

Request
Gaber
Literature



Gaber[®]
gaber.it